

# CE DFS Test Report

**Equipment** : Radio Module  
**Model No.** : SSD45N  
**Brand Name** : Laird Technologies  
**Applicant** : Laird Technologies  
**Address** : W66N220 Commerce Court, Cedarburg,  
Wisconsin 53012, USA  
**Standard** : EN 301 893 V2.1.1 (2017-05)  
**Received Date** : Apr. 19, 2017  
**Tested Date** : May 20, 2017  
**Operating Mode** : Slave without radar detection

We, International Certification Corp., would like to declare that the tested sample has been evaluated and in compliance with the requirement of the above standards. The test results contained in this report refer exclusively to the product. It may be duplicated completely for legal use with the approval of the applicant. It shall not be reproduced except in full without the written approval of our laboratory.

Reviewed by:

  
James Fan / Assistant Manager

Approved by:

  
Gary Chang / Manager



---

## Table of Contents

<b>1</b>	<b>GENERAL DESCRIPTION .....</b>	<b>5</b>
1.1	Information.....	5
1.2	Support Equipment List .....	5
1.3	Channel Loading/Data Streaming .....	6
1.4	Off Channel CAC Feature Implemented .....	6
1.5	TPC Information .....	6
1.6	DFS Parameters.....	7
1.7	Radar Test Signal.....	9
1.8	DFS Technical Requirements Specifications .....	10
1.9	Master DFS Threshold Level.....	10
1.10	Test Setup .....	11
1.11	The Equipment List .....	11
1.12	Testing Condition .....	11
1.13	Test Standards .....	11
<b>2</b>	<b>TEST RESULT .....</b>	<b>12</b>
2.1	Channel Shutdown .....	12
<b>3</b>	<b>PHOTOGRAPHS OF THE TEST CONFIGURATION .....</b>	<b>14</b>
<b>4</b>	<b>TEST LABORATORY INFORMATION .....</b>	<b>15</b>

---

## Release Record

Report No.	Version	Description	Issued Date
EY442904-04	Rev. 01	Initial issue	Jun. 03, 2017

---

## Summary of Test Results

Ref. Std. Clause	Test Items	Measured	Result
4.2.6.2.5	Channel shutdown	Meet the requirement of limit.	Pass

# 1 General Description

## 1.1 Information

This report is issued as a supplementary report to original ICC report no. EY442904-03. The modification is updating standard version from V1.8.1 to V2.1.1. Therefore, related test items had been performed and presented in the following sections.

### 1.1.1 Specification of the Equipment under Test (EUT)

<b>Frequency Range (GHz)</b>	5.15~5.25, 5.25~5.35, 5.47~5.725
<b>Wireless Function</b>	11a / HT20
<b>Operating Mode at DFS Band</b>	Slave without ad hoc and radar detection function
<b>Firmware / Software Version</b>	23.3.3.5

### 1.1.2 Antenna Details

Ant. No.	Brand / Model	Type	Connector	Operating Frequencies (MHz) / Antenna Gain (dBi)		
				5150~5250	5250~5350	5470~5725
1	MAG.LAYERS EDA-1513-25GR2-B2-CY	Dipole	SMA Jack Reverse	2	2	2
2	MAG.LAYERS PCA-4606-2G4C1-A13-CY	PCB Dipole	UFL	2.21	2.21	2.21
3	Larid NanoBlade-IP04	PCB Dipole	UFL	3.9	3.9	4
4	Larid MAF95310 Mini NanoBlade Flex	PCB Dipole	UFL	3.38	3.38	3.38
5	Ethertronics WLAN_1000146	PIFA	UFL	3.5	3.5	3.5

## 1.2 Support Equipment List

Support Equipment List				
No.	Equipment	Brand Name	Model Name	Remark
1	AP	Netgear	R6100	--
2	Notebook	DELL	LATITUDE-E6430	9ZFB4X1
3	Notebook	DELL	LATITUDE-E5420	B6FV9T1

### 1.3 Channel Loading/Data Streaming

<input checked="" type="checkbox"/>	Test transmission sequence is from the Master to the Slave.
<input checked="" type="checkbox"/>	Channel Shutdown, Off-Channel CAC Check and In-Service Monitoring with about 30% loading over 100 ms interval.
<input type="checkbox"/>	No transmissions on channels being checked during a Channel Availability Check or during an Off Channel CAC check.

### 1.4 Off Channel CAC Feature Implemented

Off Channel CAC Feature Implemented	
<input checked="" type="checkbox"/>	No
<input type="checkbox"/>	Yes
If yes, specify the Off Channel CAC Time: _____ Hours	
If the <i>Off Channel CAC Time</i> for the band 5600 MHz to 5650 MHz is different from the <i>Off-Channel CAC Time</i> for frequencies outside this band, please specify the <i>Off-Channel CAC Time</i> for the band	
If yes, specify the Off Channel CAC Time:5600 MHz to 5650 MHz: _____ Hours	
Minimum Off-Channel CAC Time	

### 1.5 TPC Information

The DFS Related Operating Mode(s) of the Equipment			
Communication Mode		<input checked="" type="checkbox"/> IP Based (Load Based)	<input type="checkbox"/> Frame Based
IEEE Std. 802.11 Protocol	Frequency Range (MHz)	TPC (Transmit Power Control)	Passive Scan
a n HT20	<input checked="" type="checkbox"/> 5250-5350	Yes	Yes
	<input checked="" type="checkbox"/> 5470-5725	Yes	Yes
	<input checked="" type="checkbox"/> 5600-5650	Yes	Yes

## 1.6 DFS Parameters

Table D.1: DFS requirement values	
Parameter	Value
Channel Availability Check Time	60 seconds (see note 1)
Minimum Off-Channel CAC Time	6 minutes (see note 2)
Maximum Off-Channel CAC Time	4 hours (see note 2)
Channel Move Time	10 seconds
Channel Closing Transmission Time	1 second.
Non-occupancy period	Minimum 30 minutes

NOTE 1: For channels whose nominal bandwidth falls completely or partly within the band 5600 MHz to 5650 MHz, the Channel Availability Check Time shall be 10 minutes.

NOTE 2: For channels whose nominal bandwidth falls completely or partly within the band 5600 MHz to 5650 MHz, the Off-Channel CAC Time shall be within the range 1 hour to 24 hours.

Table D.2: Interference threshold values	
EIRP Spectral Density (dBm/MHz)	Value (see notes 1 and 2)
10	-62

Note 1: This is the level at the input of the receiver of an RLAN device with a maximum e.i.r.p. density of 10 dBm/MHz and assuming a 0 dBi receive antenna. For devices employing different e.i.r.p. spectral density and/or a different receive antenna gain G (dBi) the DFS threshold level at the receiver input follows the following relationship:  

$$\text{DFS Detection Threshold (dBm)} = -62 + 10 \cdot \text{e.i.r.p. Spectral Density (dBm/MHz)} + G \text{ (dBi)}$$
 however the DFS threshold level shall not be less than -64 dBm assuming a 0 dBi receive antenna gain.

Note 2: Slave devices with a maximum e.i.r.p. of less than 23 dBm do not have to implement radar detection unless these devices are used in fixed outdoor point to point or fixed outdoor point to multipoint applications

Table D.3: Parameters of the reference DFS test signal		
Pulse width W [ $\mu$ s]	Pulse repetition frequency PRF [pps]	Pulses per burst [PPB]
1	700	18

**Table D.4: Parameters of radar test signals**

Radar test signal # (note 1 to 3)	Pulse width W [µs]		Pulse repetition frequency PRF (PPS)		Number of different PRFs	Pulses per burst for each PRF (PPB) (note 5)
	Min	Max	Min	Max		
1	0.5	5	200	1000	1	10 (note 6)
2	0.5	15	200	1600	1	15 (note 6)
3	0.5	15	2300	4000	1	25
4	20	30	2000	4000	1	20
5	0.5	2	300	400	2/3	10 (note 6)
6	0.5	2	400	1200	2/3	15 (note 6)

NOTE 1: Radar test signals #1 to #4 are constant PRF based signals. See figure D.1. These radar test signals are intended to simulate also radars using a packet based Staggered PRF. See figure D.2.

NOTE 2: Radar test signal #4 is a modulated radar test signal. The modulation to be used is a chirp modulation with a  $\pm 2,5$  MHz frequency deviation.

NOTE 3: Radar test signals #5 and #6 are single pulse based Staggered PRF radar test signals using 2 or 3 different PRF values. For radar test signal #5, the difference between the PRF values chosen shall be between 20 PPS and 50 PPS. For radar test signal #6, the difference between the PRF values chosen shall be between 80 PPS and 400 PPS.

NOTE 4: Apart for the Off-Channel CAC testing, the radar test signals above shall only contain a single burst of pulses. See figure D.1, figure D.3 and figure D.4. For the Off-Channel CAC testing, repetitive bursts shall be used for the total duration of the test. See figure D.2 and figure D.5. See also clause 4.7.2.3, clause 5.3.8.2.1.4.2 and clause 5.3.8.2.1.4.3.

NOTE 5: The total number of pulses in a burst is equal to the number of pulses for a single PRF multiplied by the number of different PRFs used

NOTE 6: For the CAC and Off-Channel CAC requirements, the minimum number of pulses (for each PRF) for any of the radar test signals to be detected in the band 5 600 MHz to 5 650 MHz shall be 18.

**Table D.5: Detection probability**

Parameter	Detection Probability (Pd)	
	Channels whose nominal bandwidth falls partly or completely within the 5 600 MHz to 5 650 MHz band	Other channels
<b>CAC, Off-Channel CAC</b>	<b>99,99 %</b>	<b>60 %</b>
<b>In-Service Monitoring</b>	<b>60 %</b>	<b>60 %</b>

NOTE: Pd gives the probability of detection per simulated radar burst and represents a minimum level of detection performance under defined conditions. Therefore Pd does not represent the overall detection probability for any particular radar under real life conditions.



## 1.7 Radar Test Signal

**Figure D.1: General structure of a single burst / constant PRF based radar test signal**

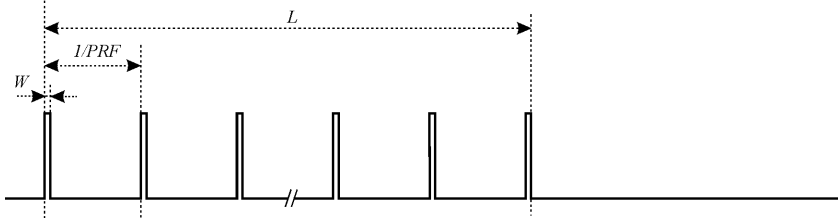

**Figure D.2: General structure of a multiple burst / constant PRF based radar test signal**

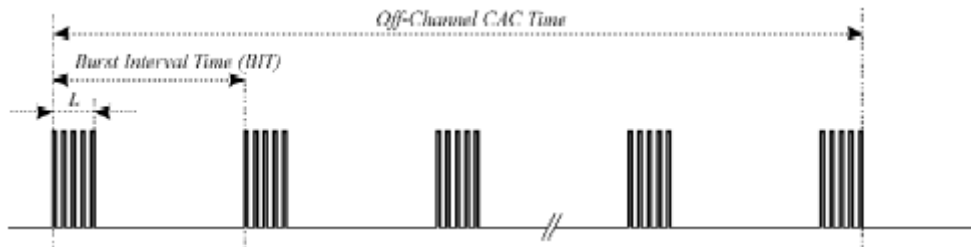

**Figure D.3: General structure of a single burst/single pulse based staggered PRF radar test signal**

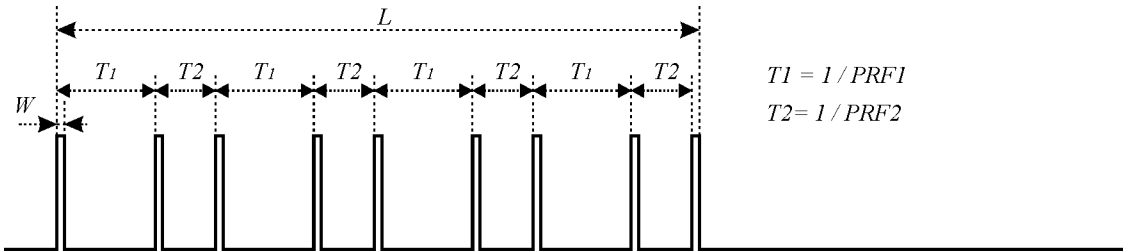

**Figure D.4: General structure of a single burst / packet based staggered PRF radar test signal**

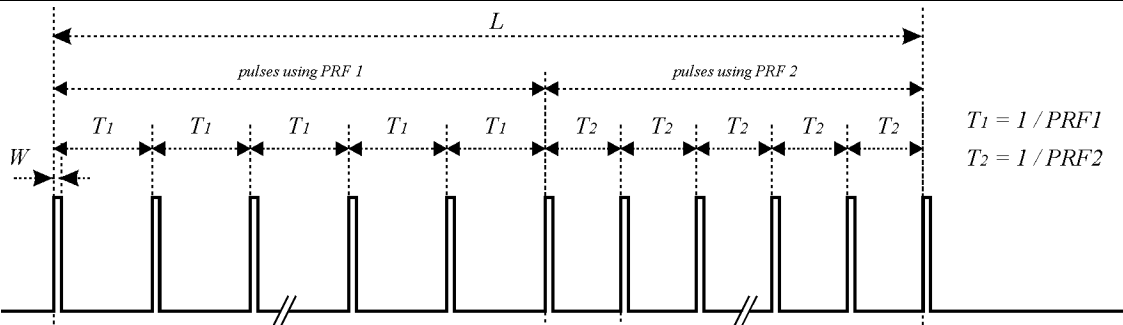

**Figure D.5: Structure of a multiple burst / packet based staggered PRF based radar test signal**

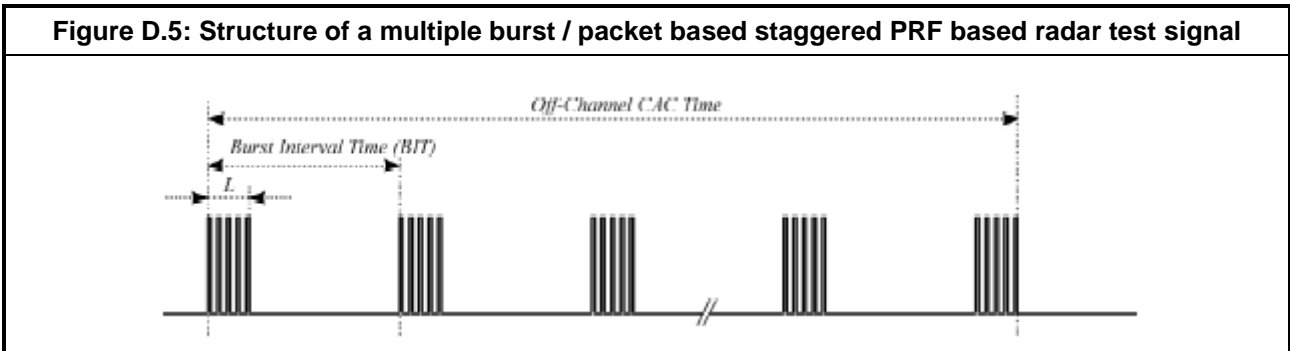

## 1.8 DFS Technical Requirements Specifications

Requirement	DFS Operational mode		
	Master	Slave without radar detection (see table D.2)	Slave with radar detection (see table D.2)
Channel Availability Check	✓	Not required	✓ (note 2)
Off-Channel CAC (note 1)	✓	Not required	✓ (note 2)
In-Service Monitoring	✓	Not required	✓
Channel Shutdown	✓	✓	✓
Non-Occupancy Period	✓	Not required	✓
Uniform Spreading	✓	Not required	Not required

Note 1: Where implemented by the manufacturer.  
 Note 2: A slave with radar detection is not required to perform a CAC or Off-Channel CAC at initial use of the channel but only after the slave has detected a radar signal on a channel by In-Service Monitoring.

## 1.9 Master DFS Threshold Level

DFS Threshold Level
DFS Threshold level: -64dBm
Note 1: DFS Detection Threshold (dBm) = $-62 + 10 \cdot \text{EIRP Spectral Density (dBm/MHz)} + G_0(\text{dBi})$ The <b>DFS Master Detection Threshold Level</b> is $(-62\text{dBm}) + 10 \cdot -16.84 + 2.9 \text{ dBi} = -65.94 \text{ dBm}$
Note 2: However, the DFS threshold level shall not be lower than -64 dBm assuming a 0 dBi receive antenna gain. If more than one antenna is intended for this TPC, range or power setting, the antenna gain of the antenna with the lowest gain shall be used.

## 1.10 Test Setup

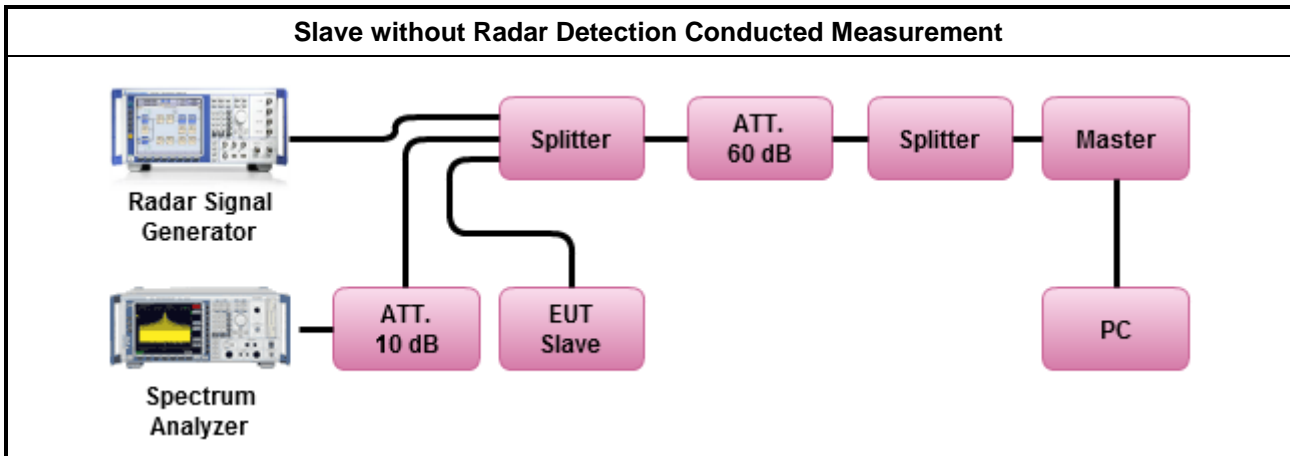

## 1.11 The Equipment List

Test Site	DF01-WS				
Instrument	Manufacturer	Model No.	Serial No.	Calibration Date	Calibration Until
Spectrum Analyzer	R&S	FSV 7	101607	Dec. 07, 2016	Dec. 06, 2017
RF Cable	HUBER+SUHNER	SUCOFLEX_104	MY15686/4	Aug. 31, 2016	Aug. 30, 2017
RF Cable	HUBER+SUHNER	SUCOFLEX_104	296081/4	Dec. 16, 2016	Dec. 15, 2017
RF Cable	HUBER+SUHNER	SUCOFLEX_104	329023/4	Dec. 16, 2016	Dec. 15, 2017
RF Cable	HUBER+SUHNER	SUCOFLEX_104	329021/4	Dec. 16, 2016	Dec. 15, 2017
Vector signal generator	R&S	SMJ100A	100498	Dec. 16, 2016	Dec. 15, 2017

Note: Calibration Interval of instruments listed above is one year.

## 1.12 Testing Condition

Test Item	Test Site	Ambient Condition	Tested By
DFS	DF01-WS	24°C / 67%	Jack Li

## 1.13 Test Standards

According to the specification of EUT, the EUT must comply with following standard.

EN 301 893 V2.1.1 (2017-05)

## 2 Test Result

### 2.1 Channel Shutdown

Test Method	
<input checked="" type="checkbox"/>	Refer as EN 301 893, clause 5.3.2 for test channel. One channel out of the declared channels for this frequency range. If more than one nominal channel bandwidth has been declared for this sub-band, testing shall be performed using the lowest and highest nominal channel bandwidth. Where the declared channel plan includes channels whose nominal channel bandwidth falls completely or partly within the 5600 MHz to 5650 MHz band, the tests for the <i>Channel Availability Check</i> (and where implemented, for the <i>Off-Channel CAC</i> ) shall be performed on one of these channels in addition to a channel within the band 5470 MHz to 5600 MHz or 5650 MHz to 5725 MHz band.
<input checked="" type="checkbox"/>	Refer as EN 301 893, clause 5.4.8.2.1.6 for <i>Channel Shutdown</i> and <i>Non-Occupancy period</i> .
<input checked="" type="checkbox"/>	Refer as EN 301 893, clause 5.4.8.2.1 for conducted measurement.
<input checked="" type="checkbox"/>	For conducted measurements on devices with multiple transmit chains and receive chains. The power splitter/combiner shall be used to combine all the transmit/receive chains (antenna outputs) into a single test point. The insertion loss of the power splitter/combiner shall be taken into account.
<input type="checkbox"/>	Refer as EN 301 893, clause 5.4.8.2.2 for radiated measurement.

Channel Shutdown Result				
Minimum Antenna Gain of Master (dBi)			2.9	
Detection Threshold Level (dBm)			-54dBm (DFS Detection Threshold -64dBm+ 10dB)	
Modulation Mode	Freq. (MHz)	Radar Test Signal	Channel Closing Transmission Time(ms)	Channel Move Time(s)
HT20	5320	table D.3	10	0.435
HT20	5500	table D.3	10	0.4925
Limit			1 sec	10 sec
Result			Complied	
Note 1: Table D.3: Parameters of the reference DFS test signal.				

## 2.1.1 Channel Shutdown Plots

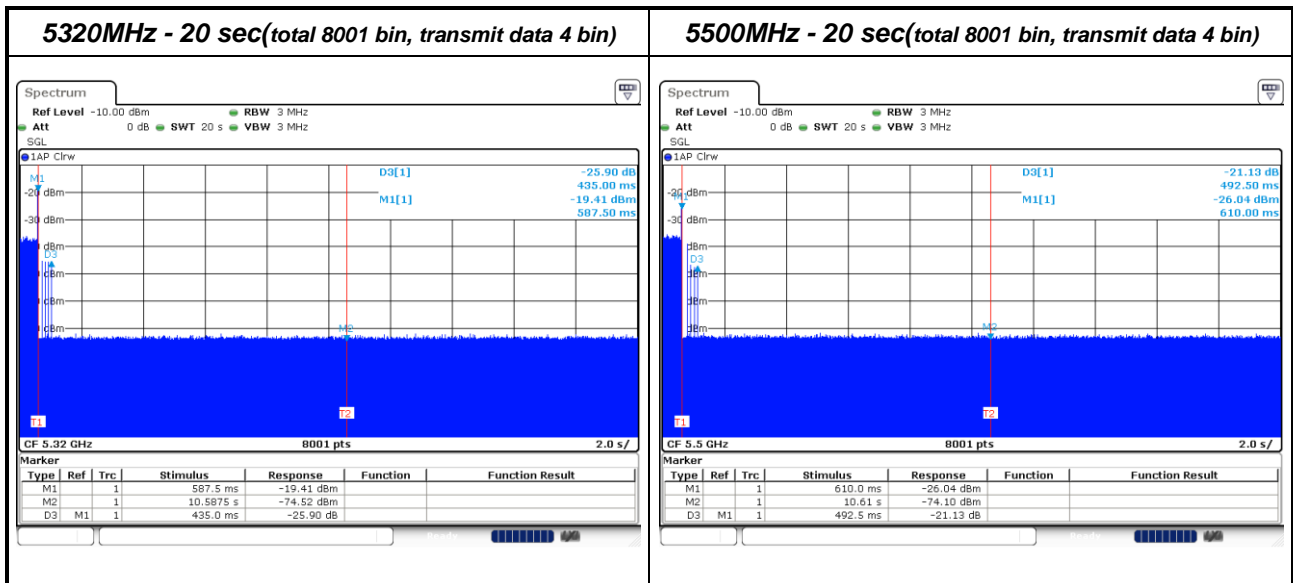

### 3 Photographs of the Test Configuration

DFS Test

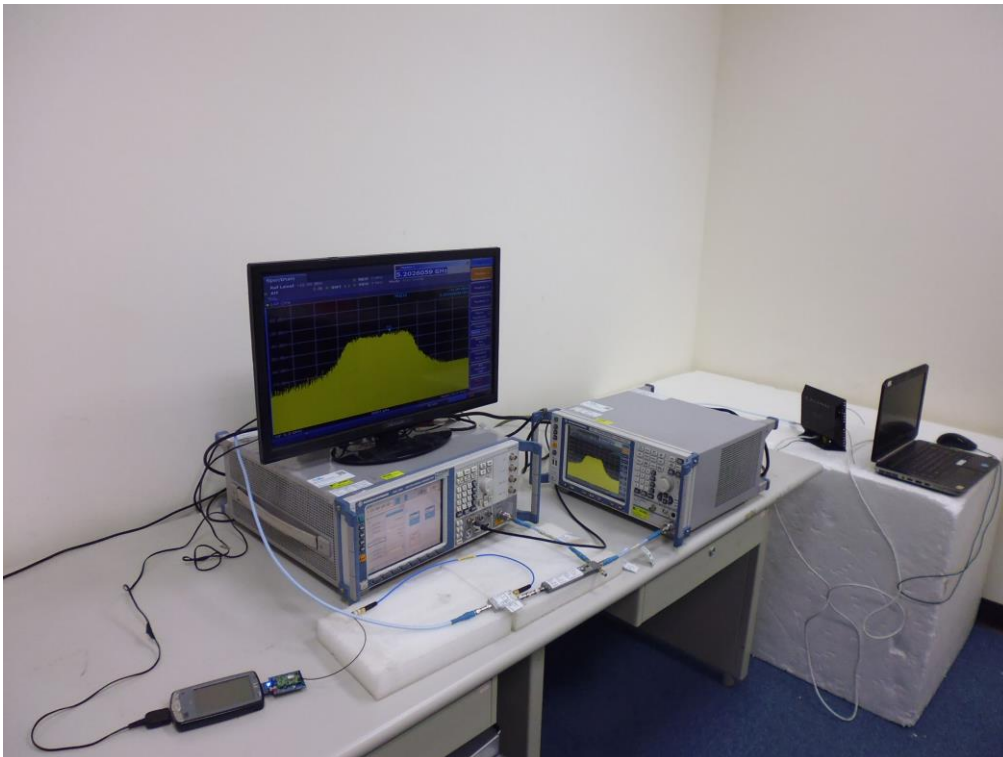
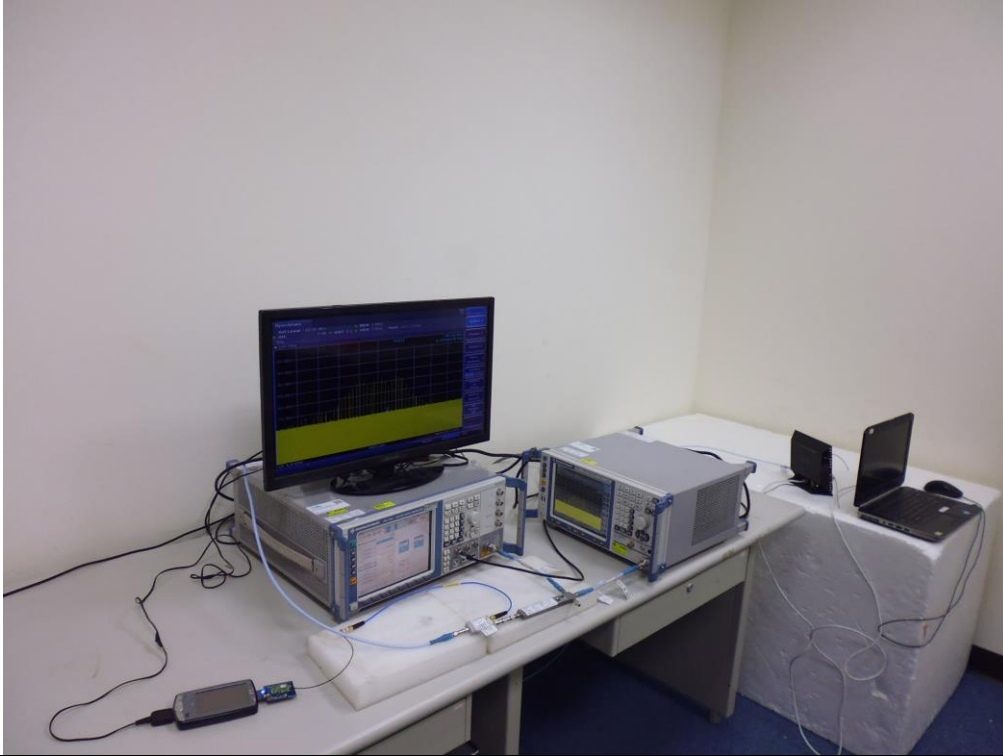

## 4 Test laboratory information

Established in 2012, ICC provides foremost EMC & RF Testing and advisory consultation services by our skilled engineers and technicians. Our services employ a wide variety of advanced edge test equipment and one of the widest certification extents in the business.

International Certification Corp, it is our definitive objective is to institute long term, trust-based associations with our clients. The expectation we set up with our clients is based on outstanding service, practical expertise and devotion to a certified value structure. Our passion is to grant our clients with best EMC / RF services by oriented knowledgeable and accommodating staff.

Our Test sites are located at Linkou District and Kwei Shan Hsiang. Location map can be found on our website <http://www.icertifi.com.tw>.

### **Linkou**

Tel: 886-2-2601-1640

No. 30-2, Ding Fwu Tsuen, Lin Kou  
District, New Taipei City, Taiwan,  
R.O.C.

### **Kwei Shan**

Tel: 886-3-271-8666

No. 3-1, Lane 6, Wen San 3rd  
St., Kwei Shan Hsiang, Tao Yuan  
Hsien 333, Taiwan, R.O.C.

### **Kwei Shan Site II**

Tel: 886-3-271-8640

No. 14-1, Lane 19, Wen San 3rd  
St., Kwei Shan Hsiang, Tao Yuan  
Hsien 333, Taiwan, R.O.C.

If you have any suggestion, please feel free to contact us as below information

Tel: 886-3-271-8666

Fax: 886-3-318-0155

Email: ICC\_Service@icertifi.com.tw

==END==