

FCC C2PC Test Report

FCC ID : TWG-SDCMSD40NBT
Equipment : 802.11abgn (1X1) + Bluetooth (2.1) module
Model No. : SDC-MSD40NBT
Brand Name : Summit
Applicant : Summit Data Communications, Inc.
Address : 526 South Main Street Suite 805 Akron, OH
44311
Standard : 47 CFR FCC Part 15.247
Received Date : Feb. 26, 2015
Tested Date : Mar. 31 ~ Apr. 28, 2015

We, International Certification Corp., would like to declare that the tested sample has been evaluated and in compliance with the requirement of the above standards. The test results contained in this report refer exclusively to the product. It may be duplicated completely for legal use with the approval of the applicant. It shall not be reproduced except in full without the written approval of our laboratory.

Approved & Reviewed by:



Gary Chang / Manager



Table of Contents

1	GENERAL DESCRIPTION	5
1.1	Information.....	5
1.2	Local Support Equipment List	7
1.3	Test Setup Chart	7
1.4	The Equipment List	8
1.5	Test Standards	9
1.6	Measurement Uncertainty	9
2	TEST CONFIGURATION	10
2.1	Testing Condition	10
2.2	The Worst Test Modes and Channel Details	10
3	TRANSMITTER TEST RESULTS.....	11
3.1	Conducted Emissions.....	11
3.2	Unwanted Emissions into Restricted Frequency Bands	14
4	TEST LABORATORY INFORMATION	18

Release Record

Report No.	Version	Description	Issued Date
FR522601AD	Rev. 01	Initial issue	May 13, 2015

Summary of Test Results

FCC Rules	Test Items	Measured	Result
15.207	Conducted Emissions	[dBuV]: 0.570MHz 35.41 (Margin -10.59dB) - AV	Pass
15.247(d) 15.209	Radiated Emissions	[dBuV/m at 3m]: 253.10MHz 36.21 (Margin -9.79dB) - PK	Pass

1 General Description

1.1 Information

1.1.1 Product Details

This report is issued for FCC class II change for changing value of some resistances and capacitances of Non-RF part. In this report, conducted emission and radiated emission below 1GHz tests had been re-tested and only its data was presented in the following sections.

1.1.2 Specification of the Equipment under Test (EUT)

RF General Information				
Frequency Range (MHz)	Bluetooth Mode	Ch. Frequency (MHz)	Channel Number	Data Rate
2400-2483.5	BR V2.1	2402-2480	0-78 [79]	1 Mbps
2400-2483.5	EDR V2.1	2402-2480	0-78 [79]	2 Mbps
2400-2483.5	EDR V2.1	2402-2480	0-78 [79]	3 Mbps

Note 1: RF output power specifies that Maximum Peak Conducted Output Power.
 Note 2: Bluetooth BR uses a GFSK.
 Note 3: Bluetooth EDR uses a combination of $\pi/4$ -DQPSK and 8DPSK.

1.1.3 Antenna Details

Ant. No.	Brand	Model	Type	Connector	Gain (dBi)
1	Cisco	AIR-ANT 4941	Dipole	RP-TNC plug	2
2	Radiall Larsen	R380.500.314	Dipole	RP-TNC plug	1.6
3	Laird	WRR2400- IP04-B	Dipole	IPEX U.FL	1.5

1.1.4 Power Supply Type of Equipment under Test (EUT)

Power Supply Type	3.3Vdc from host
--------------------------	------------------

1.1.5 Accessories

N/A

1.1.6 Support Units

Support Units		
No.	Equipment	Description
1	PDA	Brand Name: HP Model Name: HSTNH-L05C-BT
2	Adapter for PDA	Brand Name: N/A Model Name: 3A-041WE05 Power Rating: I/P: 100-240Vac, 50-60Hz, 0.2A O/P: 5.0Vdc, 1.0A Power Line: 1.85m non-shielded cable w/o core

1.1.7 Channel List

Frequency band (MHz)				2400~2483.5			
Channel	Frequency (MHz)	Channel	Frequency (MHz)	Channel	Frequency (MHz)	Channel	Frequency (MHz)
0	2402	20	2422	40	2442	60	2462
1	2403	21	2423	41	2443	61	2463
2	2404	22	2424	42	2444	62	2464
3	2405	23	2425	43	2445	63	2465
4	2406	24	2426	44	2446	64	2466
5	2407	25	2427	45	2447	65	2467
6	2408	26	2428	46	2448	66	2468
7	2409	27	2429	47	2449	67	2469
8	2410	28	2430	48	2450	68	2470
9	2411	29	2431	49	2451	69	2471
10	2412	30	2432	50	2452	70	2472
11	2413	31	2433	51	2453	71	2473
12	2414	32	2434	52	2454	72	2474
13	2415	33	2435	53	2455	73	2475
14	2416	34	2436	54	2456	74	2476
15	2417	35	2437	55	2457	75	2477
16	2418	36	2438	56	2458	76	2478
17	2419	37	2439	57	2459	77	2479
18	2420	38	2440	58	2460	78	2480
19	2421	39	2441	59	2461	---	---

1.1.8 Test Tool and Duty Cycle

Test Tool	SRU_BT
-----------	--------

1.1.9 Power Setting

Modulation Mode	Test Frequency (MHz)		
	2402	2441	2480
GFSK/1Mbps	Default	Default	Default
8DPSK/3Mbps	Default	Default	Default

1.2 Local Support Equipment List

Support Equipment List					
No.	Equipment	Brand	Model	FCC ID	Signal cable / Length (m)
1	PDA	HP	HSTNH-L05C-BT	---	---
2	Testing board	---	---	---	---

Note: No.1 was supplied by applicant.

1.3 Test Setup Chart

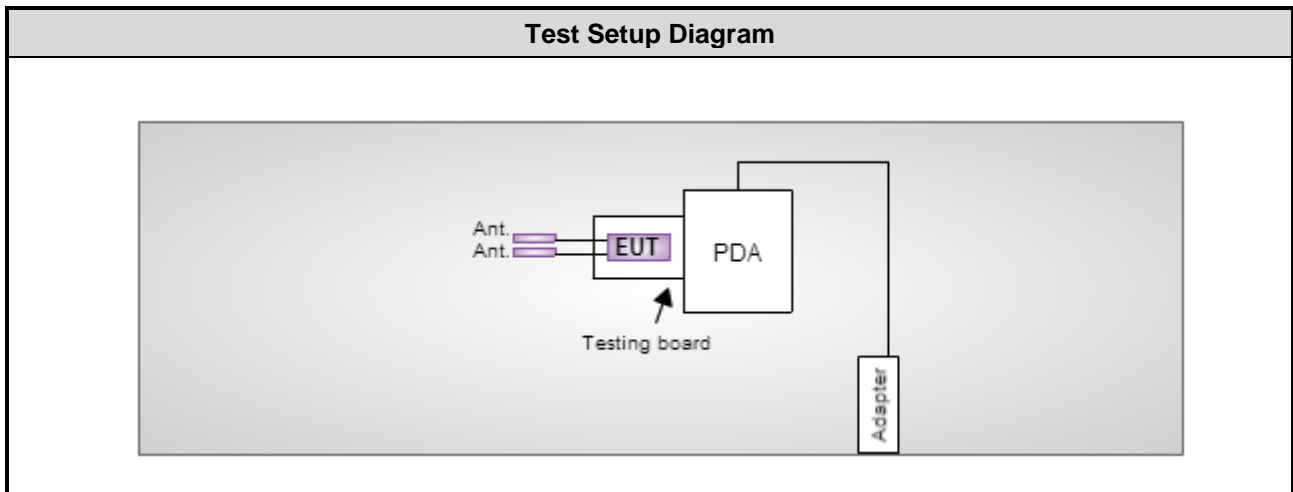

1.4 The Equipment List

Test Item	Conducted Emission				
Test Site	Conduction room 1 / (CO01-WS)				
Test Date	Mar. 31, 2015				
Instrument	Manufacturer	Model No.	Serial No.	Calibration Date	Calibration Until
EMC Receiver	R&S	ESCS 30	100169	Oct. 17, 2014	Oct. 16, 2015
LISN	SCHWARZBECK	Schwarzbeck 8127	8127-667	Nov. 17, 2014	Nov. 16, 2015
LISN (Support Unit)	SCHWARZBECK	Schwarzbeck 8127	8127-666	Nov. 26, 2014	Nov. 25, 2015
RF Cable-CON	Woken	CFD200-NL	CFD200-NL-001	Dec. 31, 2014	Dec. 30, 2015
Measurement Software	AUDIX	e3	6.120210k	NA	NA

Note: Calibration Interval of instruments listed above is one year.

Test Item	Radiated Emission				
Test Site	966 chamber 2 / (03CH02-WS)				
Test Date	Apr. 28, 2015				
Instrument	Manufacturer	Model No.	Serial No.	Calibration Date	Calibration Until
Spectrum Analyzer	R&S	FSV40	101499	Dec. 31, 2014	Dec. 30, 2015
Receiver	R&S	ESR3	101657	Jan. 15, 2015	Jan. 14, 2016
Bilog Antenna	SCHWARZBECK	VULB9168	VULB9168-524	Oct. 16, 2014	Oct. 15, 2015
Horn Antenna 1G-18G	SCHWARZBECK	BBHA 9120 D	BBHA 9120 D 1095	Oct. 14, 2014	Oct. 13, 2015
Horn Antenna 18G-40G	SCHWARZBECK	BBHA 9170	BBHA 9170517	Nov. 10, 2014	Nov. 09, 2015
Loop Antenna	R&S	HFH2-Z2	11900	Nov. 10, 2014	Nov. 09, 2015
Preamplifier	Burgeon	BPA-530	100218	Nov. 10, 2014	Nov. 09, 2015
Preamplifier	Agilent	83017A	MY39501309	Sep. 29, 2014	Sep. 28, 2015
Preamplifier	EMC	EMC184045B	980192	Aug. 26, 2014	Aug. 25, 2015
RF Cable	HUBER+SUHNER	SUCOFLEX104	MY16140/4	Dec. 16, 2014	Dec. 15, 2015
RF Cable	HUBER+SUHNER	SUCOFLEX104	MY16018/4	Dec. 16, 2014	Dec. 15, 2015
RF Cable	HUBER+SUHNER	SUCOFLEX104	MY16015/4	Dec. 16, 2014	Dec. 15, 2015
LF cable 3M	Woken	CFD400NL-LW	CFD400NL-003	Dec. 16, 2014	Dec. 15, 2015
LF cable 10M	Woken	CFD400NL-LW	CFD400NL-004	Dec. 16, 2014	Dec. 15, 2015
Measurement Software	AUDIX	e3	6.120210g	NA	NA

Note: Calibration Interval of instruments listed above is one year.

1.5 Test Standards

According to the specification of EUT, the EUT must comply with following standards and KDB documents.

47 CFR FCC Part 15.247

FCC Public notice DA 00-705

ANSI C63.10-2013

1.6 Measurement Uncertainty

ISO/IEC 17025 requires that an estimate of the measurement uncertainties associated with the emissions test results be included in the report. The measurement uncertainties given below are based on a 95% confidence level (based on a coverage factor ($k=2$))

Measurement Uncertainty	
Parameters	Uncertainty
AC conducted emission	± 2.92 dB
Radiated emission ≤ 1 GHz	± 3.62 dB
Radiated emission > 1 GHz	± 5.6 dB

2 Test Configuration

2.1 Testing Condition

Test Item	Test Site	Ambient Condition	Tested By
AC Conduction	CO01-WS	23°C / 66%	Kevin Ma
Radiated Emissions	03CH02-WS	20°C / 71%	Warren Lee

➤ FCC site registration No.: 657002

➤ IC site registration No.: 10807A-2

2.2 The Worst Test Modes and Channel Details

Test item	Mode	Test Frequency (MHz)	Data Rate (Mbps)	Test Configuration
Conducted Emissions	8DPSK	2480	1Mbps	---
Radiated Emissions ≤ 1GHz	8DPSK	2480	1Mbps	---

NOTE:

- 1) The EUT was pretested with 3 orientations placed on the table for the radiated emission measurement – X, Y, and Z-plane. The **X-plane** results were found as the worst case and were shown in this report.
- 2) 3 antennas are used for this device, the antenna with highest gain was selected for final testing.

3 Transmitter Test Results

3.1 Conducted Emissions

3.1.1 Limit of Conducted Emissions

Conducted Emissions Limit		
Frequency Emission (MHz)	Quasi-Peak	Average
0.15-0.5	66 - 56 *	56 - 46 *
0.5-5	56	46
5-30	60	50

Note 1: * Decreases with the logarithm of the frequency.

3.1.2 Test Procedures

1. The device is placed on a test table, raised 80 cm above the reference ground plane. The vertical conducting plane is located 40 cm to the rear of the device.
2. The device is connected to line impedance stabilization network (LISN) and other accessories are connected to other LISN. Measured levels of AC power line conducted emission are across the 50 Ω LISN port.
3. AC conducted emission measurements is made over frequency range from 150 kHz to 30 MHz.
4. This measurement was performed with AC 120V/60Hz

3.1.3 Test Setup

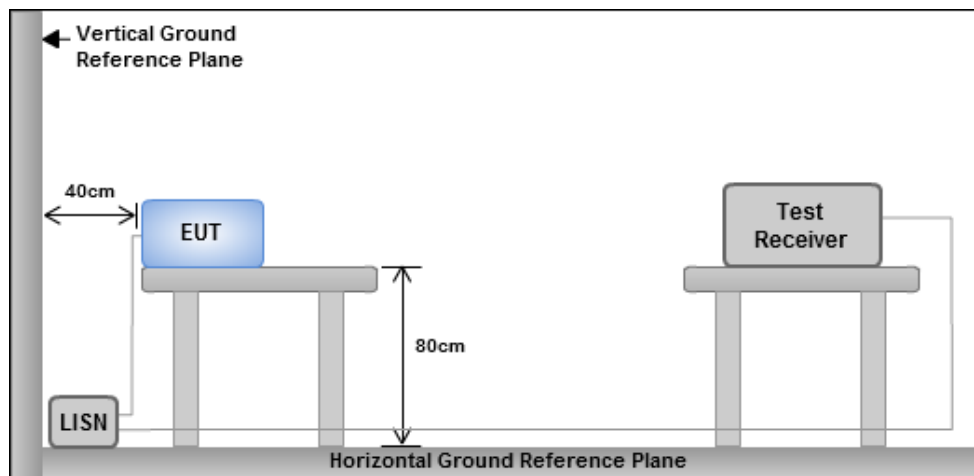

- Note: 1. Support units were connected to second LISN.
2. Both of LISNs (AMN) are 80 cm from EUT and at least 80 cm from other units and other metal planes

3.1.4 Test Result of Conducted Emissions

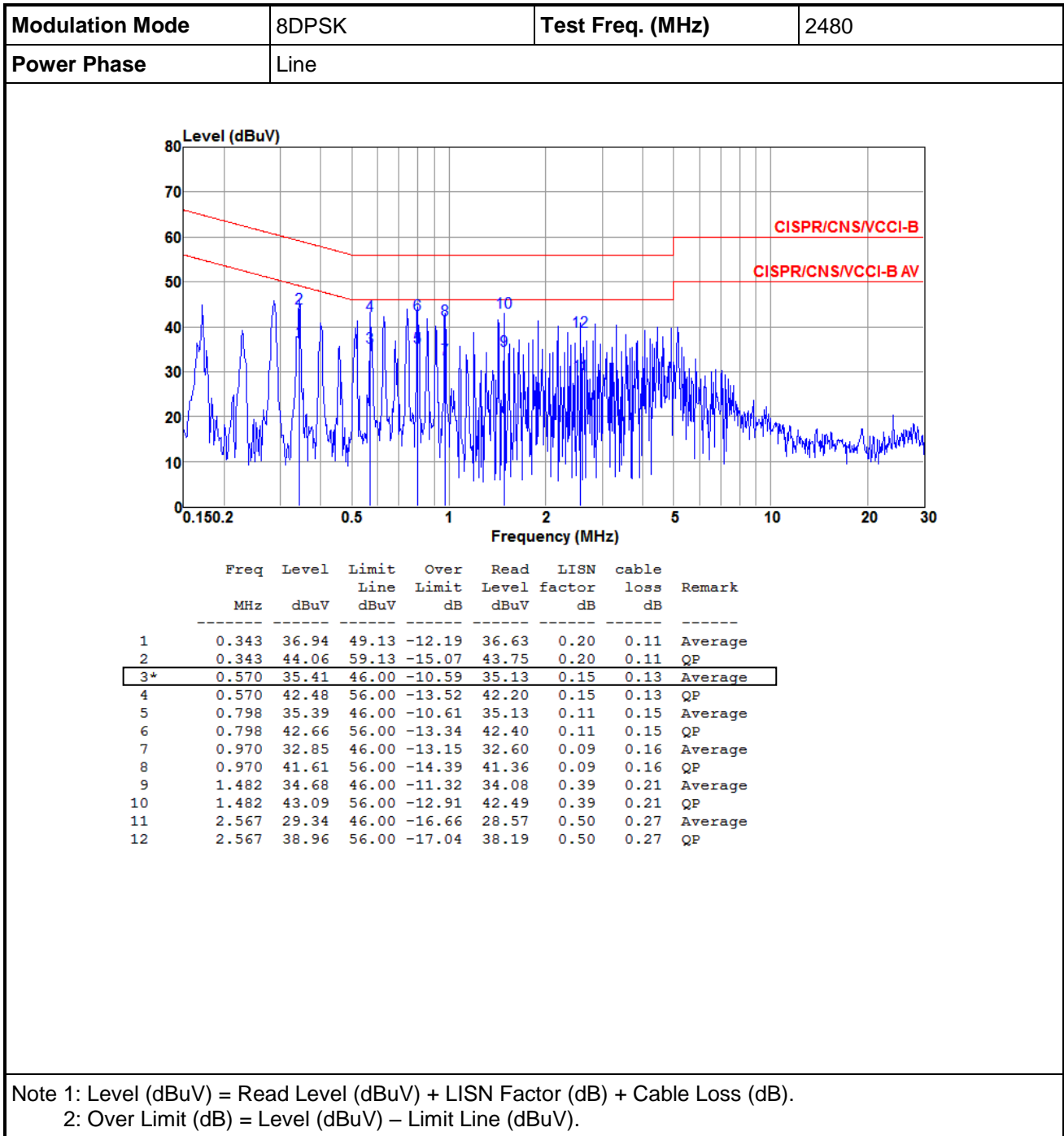

Modulation Mode	8DPSK	Test Freq. (MHz)	2480
Power Phase	Neutral		

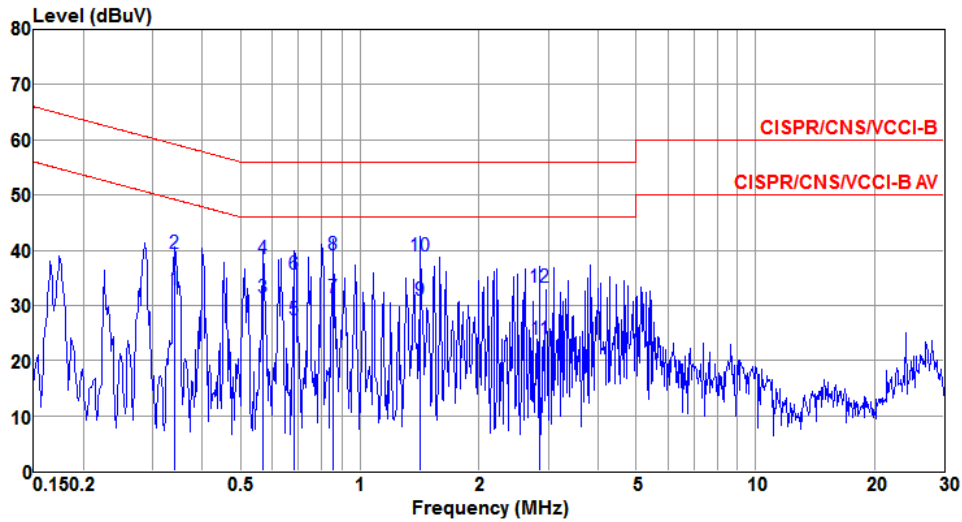

	Freq MHz	Level dBuV	Limit Line dBuV	Over Limit dB	Read Level dBuV	LISN factor dB	cable loss dB	Remark
1	0.340	32.71	49.19	-16.48	32.44	0.16	0.11	Average
2	0.340	39.51	59.19	-19.68	39.24	0.16	0.11	QP
3	0.570	31.43	46.00	-14.57	31.12	0.18	0.13	Average
4	0.570	38.54	56.00	-17.46	38.23	0.18	0.13	QP
5	0.684	27.42	46.00	-18.58	27.07	0.21	0.14	Average
6	0.684	35.76	56.00	-20.24	35.41	0.21	0.14	QP
7*	0.855	31.44	46.00	-14.56	31.04	0.25	0.15	Average
8	0.855	39.17	56.00	-16.83	38.77	0.25	0.15	QP
9	1.426	31.01	46.00	-14.99	30.57	0.24	0.20	Average
10	1.426	39.02	56.00	-16.98	38.58	0.24	0.20	QP
11	2.849	23.87	46.00	-22.13	23.10	0.49	0.28	Average
12	2.849	33.18	56.00	-22.82	32.41	0.49	0.28	QP

Note 1: Level (dBuV) = Read Level (dBuV) + LISN Factor (dB) + Cable Loss (dB).
 2: Over Limit (dB) = Level (dBuV) – Limit Line (dBuV).

3.2 Unwanted Emissions into Restricted Frequency Bands

3.2.1 Limit of Unwanted Emissions into Restricted Frequency Bands

Restricted Band Emissions Limit			
Frequency Range (MHz)	Field Strength (uV/m)	Field Strength (dBuV/m)	Measure Distance (m)
0.009~0.490	2400/F(kHz)	48.5 - 13.8	300
0.490~1.705	24000/F(kHz)	33.8 - 23	30
1.705~30.0	30	29	30
30~88	100	40	3
88~216	150	43.5	3
216~960	200	46	3
Above 960	500	54	3

Note 1:
Qusai-Peak value is measured for frequency below 1GHz except for 9–90 kHz, 110–490 kHz frequency band. Peak and average value are measured for frequency above 1GHz. The limit on average radio frequency emission is as above table. The limit on peak radio frequency emissions is 20 dB above the maximum permitted average emission limit

Note 2:
Measurements may be performed at a distance other than what is specified provided. When performing measurements at a distance other than that specified, the results shall be extrapolated to the specified distance using an extrapolation factor as below, Frequency at or above 30 MHz: 20 dB/decade Frequency below 30 MHz: 40 dB/decade.

3.2.2 Test Procedures

1. Measurement is made at a semi-anechoic chamber that incorporates a turntable allowing a EUT rotation of 360°. A continuously-rotating, remotely-controlled turntable is installed at the test site to support the EUT and facilitate determination of the direction of maximum radiation for each EUT emission frequency. The EUT is placed at test table. For emissions testing at or below 1 GHz, the table height is 80 cm above the reference ground plane.
2. Measurement is made with the antenna positioned in both the horizontal and vertical planes of polarization. The measurement antenna is varied in height (1m ~ 4m) above the reference ground plane to obtain the maximum signal strength. Distance between EUT and antenna is 3 m.
3. This investigation is performed with the EUT rotated 360°, the antenna height scanned between 1 m and 4 m, and the antenna rotated to repeat the measurements for both the horizontal and vertical antenna polarizations.

Note:

1. 120kHz measurement bandwidth of test receiver and Quasi-peak detector is for radiated emission below 1GHz.
2. Radiated emission above 1GHz / Peak value
RBW=1MHz, VBW=3MHz and Peak detector

Radiated emission above 1GHz / Average value for harmonics
The average value is: Average = Peak value + 20log(Duty cycle) Where the duty factor is calculated from following formula for DH5 packet type which has worst duty factor:
3.
$$20\log (\text{Duty cycle}) = 20\log \frac{1\text{s} / 1600 * 5}{100 \text{ ms}} = -30.1\text{dB}$$
4. Radiated emission above 1GHz / Average value for other emissions
RBW=1MHz, VBW=1/T and Peak detector

3.2.3 Test Setup

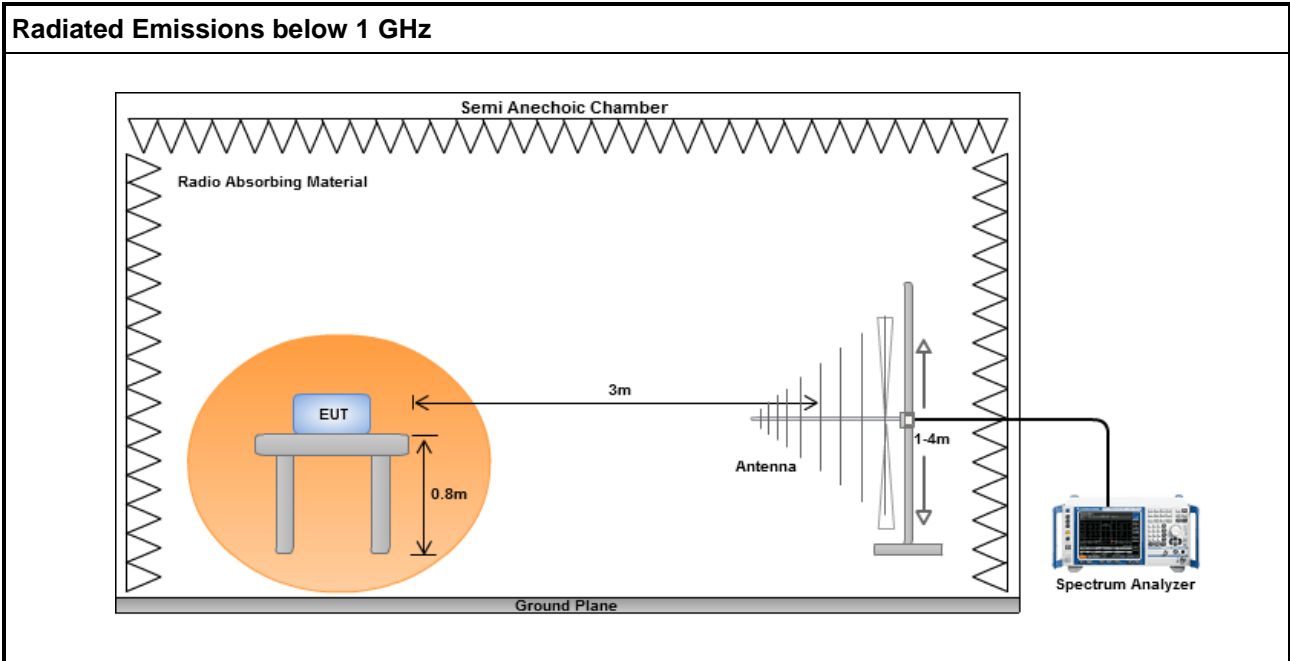

3.2.4 Transmitter Radiated Unwanted Emissions (Below 1GHz)

Modulation	8DPSK	Test Freq. (MHz)	2480
Polarization	Horizontal		

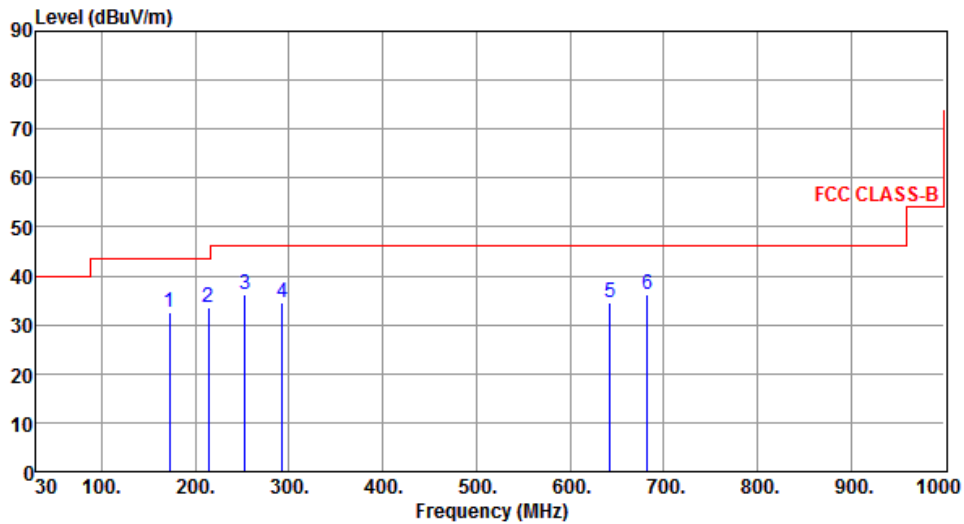

	Freq. MHz	Emission level dBuV/m	Limit dBuV/m	Margin dB	SA reading dBuV	Factor dB	Remark	ANT High cm	Turn Table deg
1	172.59	32.44	43.50	-11.06	50.15	-17.71	Peak	---	---
2	214.30	33.53	43.50	-9.97	52.80	-19.27	Peak	---	---
3	253.10	36.21	46.00	-9.79	53.86	-17.65	Peak	---	---
4	292.87	34.67	46.00	-11.33	50.87	-16.20	Peak	---	---
5	643.04	34.43	46.00	-11.57	43.32	-8.89	Peak	---	---
6	682.81	36.09	46.00	-9.91	44.41	-8.32	Peak	---	---

Note 1: Emission Level (dBuV/m) = SA Reading (dBuV/m) + Factor* (dB)

*Factor includes antenna factor, cable loss and amplifier gain

Note 2: Margin (dB) = Emission level (dBuV/m) – Limit (dBuV/m).

Note 3: All spurious emissions below 30MHz are more than 20 dB below the limit.

Modulation	8DPSK	Test Freq. (MHz)	2480
Polarization	Vertical		

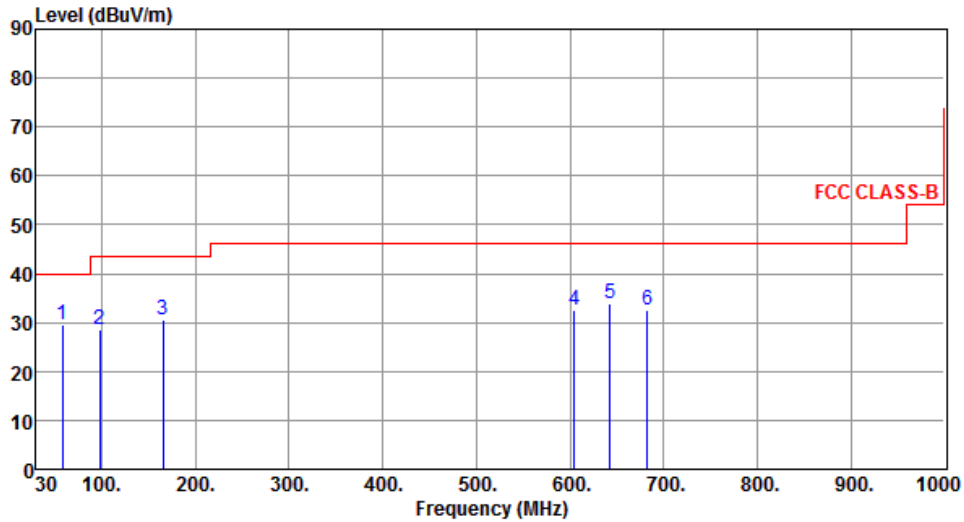

	Freq. MHz	Emission level dBuV/m	Limit dBuV/m	Margin dB	SA reading dBuV	Factor dB	Remark	ANT High cm	Turn Table deg
1	58.13	29.48	40.00	-10.52	46.31	-16.83	Peak	---	---
2	97.90	28.61	43.50	-14.89	50.79	-22.18	Peak	---	---
3	165.80	30.55	43.50	-12.95	47.75	-17.20	Peak	---	---
4	604.24	32.40	46.00	-13.60	41.65	-9.25	Peak	---	---
5	643.04	33.78	46.00	-12.22	42.67	-8.89	Peak	---	---
6	682.81	32.46	46.00	-13.54	40.78	-8.32	Peak	---	---

Note 1: Emission Level (dBuV/m) = SA Reading (dBuV/m) + Factor* (dB)

*Factor includes antenna factor , cable loss and amplifier gain

Note 2: Margin (dB) = Emission level (dBuV/m) – Limit (dBuV/m).

Note 3: All spurious emissions below 30MHz are more than 20 dB below the limit.

4 Test laboratory information

Established in 2012, ICC provides foremost EMC & RF Testing and advisory consultation services by our skilled engineers and technicians. Our services employ a wide variety of advanced edge test equipment and one of the widest certification extents in the business.

International Certification Corp, it is our definitive objective is to institute long term, trust-based associations with our clients. The expectation we set up with our clients is based on outstanding service, practical expertise and devotion to a certified value structure. Our passion is to grant our clients with best EMC / RF services by oriented knowledgeable and accommodating staff.

Our Test sites are located at Linkou District and Kwei Shan Hsiang. Location map can be found on our website <http://www.icertifi.com.tw>.

Linkou

Tel: 886-2-2601-1640

No. 30-2, Ding Fwu Tsuen, Lin Kou
District, New Taipei City, Taiwan,
R.O.C.

Kwei Shan

Tel: 886-3-271-8666

No. 3-1, Lane 6, Wen San 3rd
St., Kwei Shan Hsiang, Tao Yuan
Hsien 333, Taiwan, R.O.C.

Kwei Shan Site II

Tel: 886-3-271-8640

No. 14-1, Lane 19, Wen San 3rd
St., Kwei Shan Hsiang, Tao Yuan
Hsien 333, Taiwan, R.O.C.

If you have any suggestion, please feel free to contact us as below information

Tel: 886-3-271-8666

Fax: 886-3-318-0155

Email: ICC_Service@icertifi.com.tw

==END==