

EMC Test Report
Application for Grant of Equipment Authorization
Industry Canada RSS-Gen Issue 3 / RSS 210 Issue 8
FCC Part 15 Subpart C

Model: SDC-MSD40NBT

IC CERTIFICATION #: 6616A-SDCMSD40NBT
FCC ID: TWG-SDCMSD40NBT

APPLICANT: Summit Data Communications
526 South Main St. Suite 805
Akron, OH 44311

TEST SITE(S): Elliott Laboratories
41039 Boyce Road.
Fremont, CA. 94538-2435

IC SITE REGISTRATION #: 2845B-3; 2845B-4, 2845B-5, 2845B-7

REPORT DATE: February 29, 2012

FINAL TEST DATES: May 18, 19 and 20, December 16, 20 and 23,
2011 and February 6 and 8, 2012

TOTAL NUMBER OF PAGES: 94

PROGRAM MGR /
TECHNICAL REVIEWER:



Mark E Hill
Staff Engineer

QUALITY ASSURANCE DELEGATE /
FINAL REPORT PREPARER:

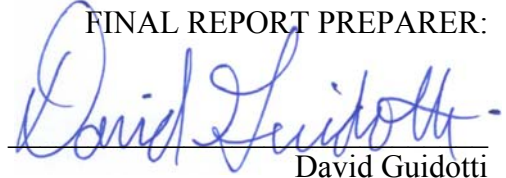

David Guidotti
Senior Technical Writer



Elliott Laboratories is accredited by the A2LA, certificate number 0214.26, to perform the test(s) listed in this report, except where noted otherwise. This report and the information contained herein represent the results of testing test articles identified and selected by the client performed to specifications and/or procedures selected by the client. National Technical Systems (NTS) makes no representations, expressed or implied, that such testing is adequate (or inadequate) to demonstrate efficiency, performance, reliability, or any other characteristic of the articles being tested, or similar products. This report should not be relied upon as an endorsement or certification by NTS of the equipment tested, nor does it represent any statement whatsoever as to its merchantability or fitness of the test article, or similar products, for a particular purpose. This report shall not be reproduced except in full

REVISION HISTORY

Rev#	Date	Comments	Modified By
-	2-29-2012	First release	

TABLE OF CONTENTS

REVISION HISTORY	2
TABLE OF CONTENTS	3
SCOPE.....	4
OBJECTIVE	5
STATEMENT OF COMPLIANCE.....	5
DEVIATIONS FROM THE STANDARDS.....	5
TEST RESULTS SUMMARY	6
DIGITAL TRANSMISSION SYSTEMS (2400 – 2483.5MHZ).....	6
DIGITAL TRANSMISSION SYSTEMS (5725 –5850 MHZ).....	7
GENERAL REQUIREMENTS APPLICABLE TO ALL BANDS.....	8
MEASUREMENT UNCERTAINTIES.....	9
EQUIPMENT UNDER TEST (EUT) DETAILS.....	10
GENERAL.....	10
OTHER EUT DETAILS.....	10
ANTENNA SYSTEM	10
ENCLOSURE.....	10
MODIFICATIONS.....	10
SUPPORT EQUIPMENT.....	11
EUT INTERFACE PORTS	11
EUT OPERATION	11
TEST SITE.....	12
GENERAL INFORMATION.....	12
CONDUCTED EMISSIONS CONSIDERATIONS	12
RADIATED EMISSIONS CONSIDERATIONS	12
MEASUREMENT INSTRUMENTATION	13
RECEIVER SYSTEM	13
INSTRUMENT CONTROL COMPUTER	13
LINE IMPEDANCE STABILIZATION NETWORK (LISN).....	13
FILTERS/ATTENUATORS	14
ANTENNAS.....	14
ANTENNA MAST AND EQUIPMENT TURNTABLE.....	14
INSTRUMENT CALIBRATION.....	14
TEST PROCEDURES	15
EUT AND CABLE PLACEMENT	15
CONDUCTED EMISSIONS.....	15
RADIATED EMISSIONS.....	16
CONDUCTED EMISSIONS FROM ANTENNA PORT	18
BANDWIDTH MEASUREMENTS	18
SPECIFICATION LIMITS AND SAMPLE CALCULATIONS	19
CONDUCTED EMISSIONS SPECIFICATION LIMITS: FCC 15.207; FCC 15.107(A), RSS GEN	19
GENERAL TRANSMITTER RADIATED EMISSIONS SPECIFICATION LIMITS	20
RECEIVER RADIATED SPURIOUS EMISSIONS SPECIFICATION LIMITS	20
OUTPUT POWER LIMITS – DIGITAL TRANSMISSION SYSTEMS	21
TRANSMIT MODE SPURIOUS RADIATED EMISSIONS LIMITS – FHSS AND DTS SYSTEMS.....	21
SAMPLE CALCULATIONS - CONDUCTED EMISSIONS	21
SAMPLE CALCULATIONS - RADIATED EMISSIONS.....	22
SAMPLE CALCULATIONS - FIELD STRENGTH TO EIRP CONVERSION.....	23
APPENDIX A TEST EQUIPMENT CALIBRATION DATA	24
APPENDIX B TEST DATA	26
END OF REPORT	94

SCOPE

An electromagnetic emissions test has been performed on the Summit Data Communications model SDC-MSD40NBT, pursuant to the following rules:

Industry Canada RSS-Gen Issue 3
RSS 210 Issue 8 "Low-power Licence-exempt Radiocommunication Devices (All Frequency Bands): Category I Equipment"
FCC Part 15 Subpart C

Conducted and radiated emissions data has been collected, reduced, and analyzed within this report in accordance with measurement guidelines set forth in the following reference standards and as outlined in Elliott Laboratories test procedures:

ANSI C63.4:2003
FCC DTS Measurement Procedure KDB558074 D01, Dated 1/18/2012

The intentional radiator above has been tested in a simulated typical installation to demonstrate compliance with the relevant Industry Canada performance and procedural standards.

Final system data was gathered in a mode that tended to maximize emissions by varying orientation of EUT, orientation of power and I/O cabling, antenna search height, and antenna polarization.

Every practical effort was made to perform an impartial test using appropriate test equipment of known calibration. All pertinent factors have been applied to reach the determination of compliance.

OBJECTIVE

The primary objective of the manufacturer is compliance with the regulations outlined in the previous section.

Prior to marketing in the USA, all unlicensed transmitters and transceivers require certification. Receive-only devices operating between 30 MHz and 960 MHz are subject to either certification or a manufacturer's declaration of conformity, with all other receive-only devices exempt from the technical requirements.

Prior to marketing in Canada, Class I transmitters, receivers and transceivers require certification. Class II devices are required to meet the appropriate technical requirements but are exempt from certification requirements.

Certification is a procedure where the manufacturer submits test data and technical information to a certification body and receives a certificate or grant of equipment authorization upon successful completion of the certification body's review of the submitted documents. Once the equipment authorization has been obtained, the label indicating compliance must be attached to all identical units, which are subsequently manufactured.

Maintenance of compliance is the responsibility of the manufacturer. Any modification of the product which may result in increased emissions should be checked to ensure compliance has been maintained (i.e., printed circuit board layout changes, different line filter, different power supply, harnessing or I/O cable changes, etc.).

STATEMENT OF COMPLIANCE

The tested sample of Summit Data Communications model SDC-MSD40NBT complied with the requirements of the following regulations:

Industry Canada RSS-Gen Issue 3
RSS 210 Issue 8 "Low-power Licence-exempt Radiocommunication Devices (All Frequency Bands): Category I Equipment"
FCC Part 15 Subpart C

Maintenance of compliance is the responsibility of the manufacturer. Any modifications to the product should be assessed to determine their potential impact on the compliance status of the device with respect to the standards detailed in this test report.

The test results recorded herein are based on a single type test of Summit Data Communications model SDC-MSD40NBT and therefore apply only to the tested sample. The sample was selected and prepared by Ron Seide of Summit Data Communications.

DEVIATIONS FROM THE STANDARDS

No deviations were made from the published requirements listed in the scope of this report.

TEST RESULTS SUMMARY**DIGITAL TRANSMISSION SYSTEMS (2400 – 2483.5MHz)**

FCC Rule Part	RSS Rule Part	Description	Measured Value / Comments	Limit / Requirement	Result
15.247(a)	RSS 210 A8.2	Digital Modulation	Systems uses OFDM / DSSS techniques	System must utilize a digital transmission technology	Complies
15.247 (a) (2)	RSS 210 A8.2 (1)	6dB Bandwidth	802.11b: 9.0MHz 802.11g: 15.1MHz 802.11n20: 15.1MHz	>500kHz	Complies
15.247 (b) (3)	RSS 210 A8.2 (4)	Output Power (multipoint systems)	802.11b: 15.9dBm (0.039 Watts) 802.11g: 14.7dBm (0.030 Watts) 802.11n20: 14.2dBm (0.026W) EIRP = 0.062 W ^{Note 1}	1 Watt, EIRP limited to 4 Watts.	Complies
15.247(d)	RSS 210 A8.2 (2)	Power Spectral Density	802.11b: -5.3dBm/3kHz 802.11g: -12.3dBm/3kHz 802.11n20: -13.6dBm/3kHz	8dBm/3kHz	Complies
15.247(c)	RSS 210 A8.5	Antenna Port Spurious Emissions 30MHz – 25 GHz	All spurious emissions < -30dBc	< -30dBc ^{Note 2}	Complies
15.247(c) / 15.209	RSS 210 A8.5	Radiated Spurious Emissions 30MHz – 25 GHz	53.3dBμV/m @ 2389.7MHz (-0.7dB)	15.207 in restricted bands, all others <-30dBc ^{Note 2}	Complies
<p>Note 1: EIRP calculated using antenna gain of 2.0 dBi for the highest EIRP system.</p> <p>Note 2: Limit of -30dBc used because the power was measured using the UNII test procedure (maximum power averaged over a transmission burst).</p>					

DIGITAL TRANSMISSION SYSTEMS (5725 –5850 MHz)

FCC Rule Part	RSS Rule Part	Description	Measured Value / Comments	Limit / Requirement	Result
15.247(a)	RSS 210 A8.2	Digital Modulation	Systems uses OFDM / DSSS techniques	System must utilize a digital transmission technology	Complies
15.247 (a) (2)	RSS 210 A8.2 (1)	6dB Bandwidth	802.11a: 15.0MHz 802.11n20: 15.0MHz	>500kHz	Complies
15.247 (b)	RSS 210 A8.2 (4)	Output Power (multipoint systems)	802.11a: 15.8dBm (0.038 Watts) 802.11n20: 15.7dBm (0.037 Watts) EIRP = 0.117 W ^{Note 1}	1Watt, EIRP limited to 4 Watts.	Complies
15.247(d)	RSS 210 A8.2 (2)	Power Spectral Density	802.11a: -16.6dBm/3kHz 802.11n20: -11.1dBm/3kHz	Maximum permitted is 8dBm/3kHz	Complies
15.247(c)	RSS 210 A8.5	Antenna Port Spurious Emissions – 30MHz – 40 GHz	All spurious emissions < -30dBc	< -30dBc ^{Note 2}	Complies
15.247(c) / 15.209	RSS 210 A8.5 Table 2, 3	Radiated Spurious Emissions 30MHz – 40 GHz	47.8dB μ V/m @ 11569.4MHz (-6.2dB)	15.207 in restricted bands, all others <-30dBc ^{Note 2}	Complies
<p>Note 1: EIRP calculated using antenna gain of 5.0 dBi for the highest EIRP system multi-point system.</p> <p>Note 2: Limit of -30dBc used because the power was measured using the UNII test procedure (maximum power averaged over a transmission burst).</p>					

GENERAL REQUIREMENTS APPLICABLE TO ALL BANDS

FCC Rule Part	RSS Rule part	Description	Measured Value / Comments	Limit / Requirement	Result (margin)
15.203	-	RF Connector	EUT uses u.FL connectors	Unique or integral antenna required	Complies
15.207	RSS GEN Table 2	AC Conducted Emissions	31.9dB μ V @ 19.501MHz (-18.1dB)	Refer to page 19	Complies
15.109	RSS GEN 7.2.3 Table 1	Receiver spurious emissions	40.9dB μ V/m @ 1345.5MHz (-13.1dB)	Refer to page 20	Complies
15.247 (b) (5) 15.407 (f)	RSS 102	RF Exposure Requirements	Refer to MPE calculations in Exhibit 11, RSS 102 declaration and User Manual statements.	Refer to OET 65, FCC Part 1 and RSS 102	Complies
-	RSP 100 RSS GEN 7.1.5	User Manual		Statement required regarding non-interference	Complies
-	RSP 100 RSS GEN 7.1.5	User Manual		Statement for products with detachable antenna	Complies
-	RSP 100 RSS GEN 4.4.1	99% Bandwidth	802.11b: 12.8MHz 802.11g: 18.5MHz 2.4GHz, 802.11n20: 20.1MHz 802.11a: 18.9MHz 5GHz, 802.11n20: 22.8MHz	Information only	N/A

MEASUREMENT UNCERTAINTIES

ISO/IEC 17025 requires that an estimate of the measurement uncertainties associated with the emissions test results be included in the report. The measurement uncertainties given below are based on a 95% confidence level and were calculated in accordance with UKAS document LAB 34.

Measurement Type	Measurement Unit	Frequency Range	Expanded Uncertainty
RF power, conducted (power meter)	dBm	25 to 7000 MHz	± 0.52 dB
RF power, conducted (Spectrum analyzer)	dBm	25 to 7000 MHz	± 0.7 dB
Conducted emission of transmitter	dBm	25 to 26500 MHz	± 0.7 dB
Conducted emission of receiver	dBm	25 to 26500 MHz	± 0.7 dB
Radiated emission (substitution method)	dBm	25 to 26500 MHz	± 2.5 dB
Radiated emission (field strength)	dB μ V/m	25 to 1000 MHz	± 3.6 dB
		1000 to 40000 MHz	± 6.0 dB
Conducted Emissions (AC Power)	dB μ V	0.15 to 30 MHz	± 2.4 dB

EQUIPMENT UNDER TEST (EUT) DETAILS**GENERAL**

The Summit Data Communications model SDC-MSD40NBT is an 802.11abgn 1x1 with Bluetooth 2.1 module.

The sample was received on October 19, 2010 and tested on May 18, 19 and 20, December 16, 20 and 23, 2011 and February 6 and 8, 2012. The EUT consisted of the following component(s):

Company	Model	Description	Serial Number	FCC ID
Summit	SDC-MSD40NBT	802.11abgn 1x with BT	Prototype	TWG-SDCMSD40NB T

OTHER EUT DETAILS

The EUT supports single transmit chain operation. The EUT supports 20MHz operation only.

ANTENNA SYSTEM

Dipole Antenna #1 - 2.4 and 5GHz bands - Larsen, R380.500.314, 1.6dBi (2.4GHz), 5dBi (5GHz)

Dipole Antenna #2 - 2.4 GHz only - Cisco Air-Ant 4941 2dBi(2.4GHz)

In the 2.4GHz range, the Cisco antenna was tested as they represented the highest gain antennas of each available type.

In the 5GHz range, Larsen antenna was tested as the represented the highest gain antennas of each available type.

The antenna connects to the EUT via a non-standard u.FL antenna connector, thereby meeting the requirements of FCC 15.203.

ENCLOSURE

The EUT has no enclosure. It is designed to be installed within the enclosure of a host computer.

MODIFICATIONS

No modifications were made to the EUT during the time the product was at Elliott.

SUPPORT EQUIPMENT

The following equipment was used as support equipment for testing:

Company	Model	Description	Serial Number	FCC ID
Delta Electronics	EADP-10BB	AC/DC Adapter	59A401Z9UP42 K	N/A
HP	iPaQ	PDA	2CK702010G	N/A

EUT INTERFACE PORTS

The I/O cabling configuration during testing was as follows:

Port	Connected To	Description	Cable(s) Shielded or Unshielded	Length(m)
AC/DC Adapter	iPaq	2wire	Unshielded	1.5m
AC/DC Adapter	AC Mains	-	-	-

EUT OPERATION

During testing, the EUT was configured to transmit continuously at the lowest data rate for the mode as this resulted in the highest output power.

TEST SITE**GENERAL INFORMATION**

Final test measurements were taken at the test sites listed below. Pursuant to section 2.948 of the FCC's Rules and section 3.3 of RSP-100, construction, calibration, and equipment data has been filed with the Commission and with industry Canada.

Site	Registration Numbers		Location
	FCC	Canada	
Chamber 3	769238	2845B-3	41039 Boyce Road Fremont, CA 94538-2435
Chamber 4	211948	2845B-4	
Chamber 5	211948	2845B-5	
Chamber 7	A2LA accreditation	2845B-7	

ANSI C63.4:2003 recommends that ambient noise at the test site be at least 6 dB below the allowable limits. Ambient levels are below this requirement. The test site(s) contain separate areas for radiated and conducted emissions testing. Considerable engineering effort has been expended to ensure that the facilities conform to all pertinent requirements of ANSI C63.4:2003.

CONDUCTED EMISSIONS CONSIDERATIONS

Conducted emissions testing is performed in conformance with ANSI C63.4:2003. Measurements are made with the EUT connected to the public power network through a nominal, standardized RF impedance, which is provided by a line impedance stabilization network, known as a LISN. A LISN is inserted in series with each current-carrying conductor in the EUT power cord.

RADIATED EMISSIONS CONSIDERATIONS

The FCC has determined that radiation measurements made in a shielded enclosure are not suitable for determining levels of radiated emissions. Radiated measurements are performed in an open field environment or in a semi-anechoic chamber. The test sites are maintained free of conductive objects within the CISPR defined elliptical area incorporated in ANSI C63.4:2003 guidelines and meet the Normalized Site Attenuation (NSA) requirements of ANSI C63.4:2003.

MEASUREMENT INSTRUMENTATION

RECEIVER SYSTEM

An EMI receiver as specified in CISPR 16-1-1 is used for emissions measurements. The receivers used can measure over the frequency range of 9 kHz up to 2000 MHz. These receivers allow both ease of measurement and high accuracy to be achieved. The receivers have Peak, Average, and CISPR (Quasi-peak) detectors built into their design so no external adapters are necessary. The receiver automatically sets the required bandwidth for the CISPR detector used during measurements. If the repetition frequency of the signal being measured is below 20Hz, peak measurements are made in lieu of Quasi-Peak measurements.

For measurements above the frequency range of the receivers, a spectrum analyzer is utilized because it provides visibility of the entire spectrum along with the precision and versatility required to support engineering analysis. Average measurements above 1000MHz are performed on the spectrum analyzer using the linear-average method with a resolution bandwidth of 1 MHz and a video bandwidth of 10 Hz, unless the signal is pulsed in which case the average (or video) bandwidth of the measuring instrument is reduced to onset of pulse desensitization and then increased.

INSTRUMENT CONTROL COMPUTER

The receivers utilize either a Rohde & Schwarz EZM Spectrum Monitor/Controller or contain an internal Spectrum Monitor/Controller to view and convert the receiver measurements to the field strength at an antenna or voltage developed at the LISN measurement port, which is then compared directly with the appropriate specification limit. This provides faster, more accurate readings by performing the conversions described under Sample Calculations within the Test Procedures section of this report. Results are printed in a graphic and/or tabular format, as appropriate. A personal computer is used to record all measurements made with the receivers.

The Spectrum Monitor provides a visual display of the signal being measured. In addition, the controller or a personal computer run automated data collection programs which control the receivers. This provides added accuracy since all site correction factors, such as cable loss and antenna factors are added automatically.

LINE IMPEDANCE STABILIZATION NETWORK (LISN)

Line conducted measurements utilize a fifty microhenry Line Impedance Stabilization Network as the monitoring point. The LISN used also contains a 250 uH CISPR adapter. This network provides for calibrated radio frequency noise measurements by the design of the internal low pass and high pass filters on the EUT and measurement ports, respectively.

FILTERS/ATTENUATORS

External filters and precision attenuators are often connected between the receiving antenna or LISN and the receiver. This eliminates saturation effects and non-linear operation due to high amplitude transient events.

ANTENNAS

A loop antenna is used below 30 MHz. For the measurement range 30 MHz to 1000 MHz either a combination of a biconical antenna and a log periodic or a bi-log antenna is used. Above 1000 MHz, horn antennas are used. The antenna calibration factors to convert the received voltage to an electric field strength are included with appropriate cable loss and amplifier gain factors to determine an overall site factor, which is then programmed into the test receivers or incorporated into the test software.

ANTENNA MAST AND EQUIPMENT TURNTABLE

The antennas used to measure the radiated electric field strength are mounted on a non-conductive antenna mast equipped with a motor-drive to vary the antenna height. Measurements below 30 MHz are made with the loop antenna at a fixed height of 1m above the ground plane.

ANSI C63.4:2003 specifies that the test height above ground for table mounted devices shall be 80 centimeters. Floor mounted equipment shall be placed on the ground plane if the device is normally used on a conductive floor or separated from the ground plane by insulating material from 3 to 12 mm if the device is normally used on a non-conductive floor. During radiated measurements, the EUT is positioned on a motorized turntable in conformance with this requirement.

INSTRUMENT CALIBRATION

All test equipment is regularly checked to ensure that performance is maintained in accordance with the manufacturer's specifications. All antennas are calibrated at regular intervals with respect to tuned half-wave dipoles. An exhibit of this report contains the list of test equipment used and calibration information.

TEST PROCEDURES

EUT AND CABLE PLACEMENT

The regulations require that interconnecting cables be connected to the available ports of the unit and that the placement of the unit and the attached cables simulate the worst case orientation that can be expected from a typical installation, so far as practicable. To this end, the position of the unit and associated cabling is varied within the guidelines of ANSI C63.4:2003, and the worst-case orientation is used for final measurements.

CONDUCTED EMISSIONS

Conducted emissions are measured at the plug end of the power cord supplied with the EUT. Excess power cord length is wrapped in a bundle between 30 and 40 centimeters in length near the center of the cord. Preliminary measurements are made to determine the highest amplitude emission relative to the specification limit for all the modes of operation. Placement of system components and varying of cable positions are performed in each mode. A final peak mode scan is then performed in the position and mode for which the highest emission was noted on all current carrying conductors of the power cord.

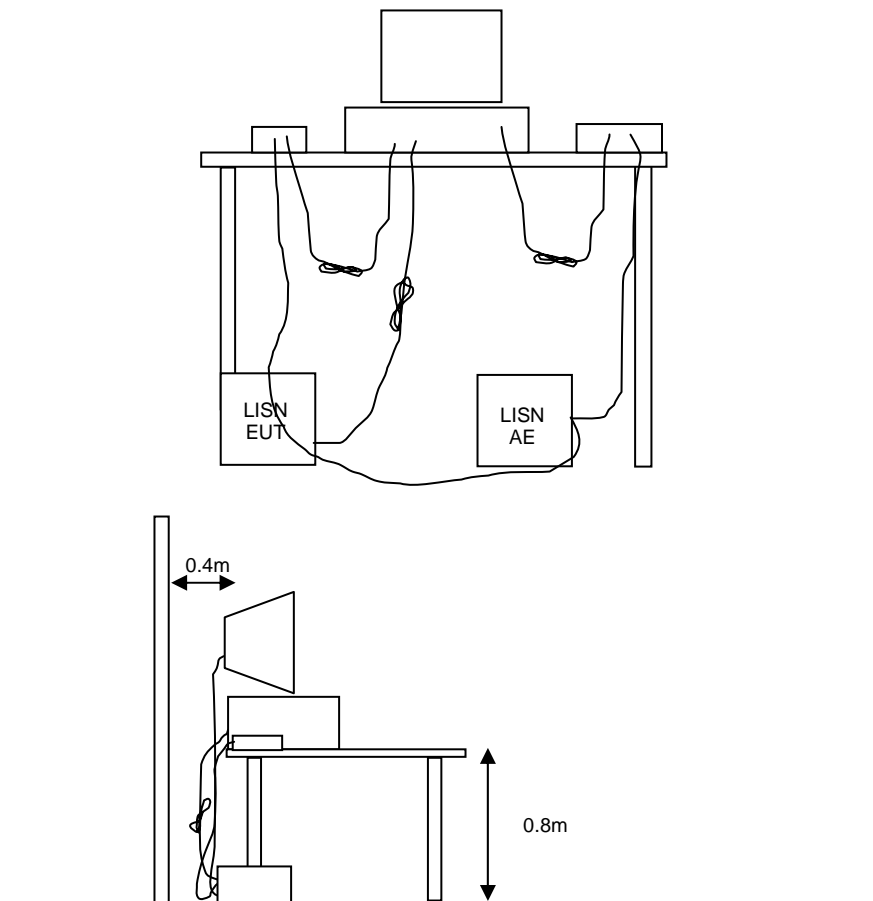

Figure 1 Typical Conducted Emissions Test Configuration

RADIATED EMISSIONS

A preliminary scan of the radiated emissions is performed in which all significant EUT frequencies are identified with the system in a nominal configuration. At least two scans are performed, one scan for each antenna polarization (horizontal and vertical; loop parallel and perpendicular to the EUT). During the preliminary scans, the EUT is rotated through 360°, the antenna height is varied (for measurements above 30 MHz) and cable positions are varied to determine the highest emission relative to the limit. Preliminary scans may be performed in a fully anechoic chamber for the purposes of identifying the frequencies of the highest emissions from the EUT.

A speaker is provided in the receiver to aid in discriminating between EUT and ambient emissions. Other methods used during the preliminary scan for EUT emissions involve scanning with near field magnetic loops, monitoring I/O cables with RF current clamps, and cycling power to the EUT.

Final maximization is a phase in which the highest amplitude emissions identified in the spectral search are viewed while the EUT azimuth angle is varied from 0 to 360 degrees relative to the receiving antenna. The azimuth, which results in the highest emission is then maintained while varying the antenna height from one to four meters (for measurements above 30 MHz, measurements below 30 MHz are made with the loop antenna at a fixed height of 1m). The result is the identification of the highest amplitude for each of the highest peaks. Each recorded level is corrected in the receiver using appropriate factors for cables, connectors, antennas, and preamplifier gain.

When testing above 18 GHz, the receive antenna is located at 1 meter from the EUT and the antenna height is restricted to a maximum of 2.5 meters.

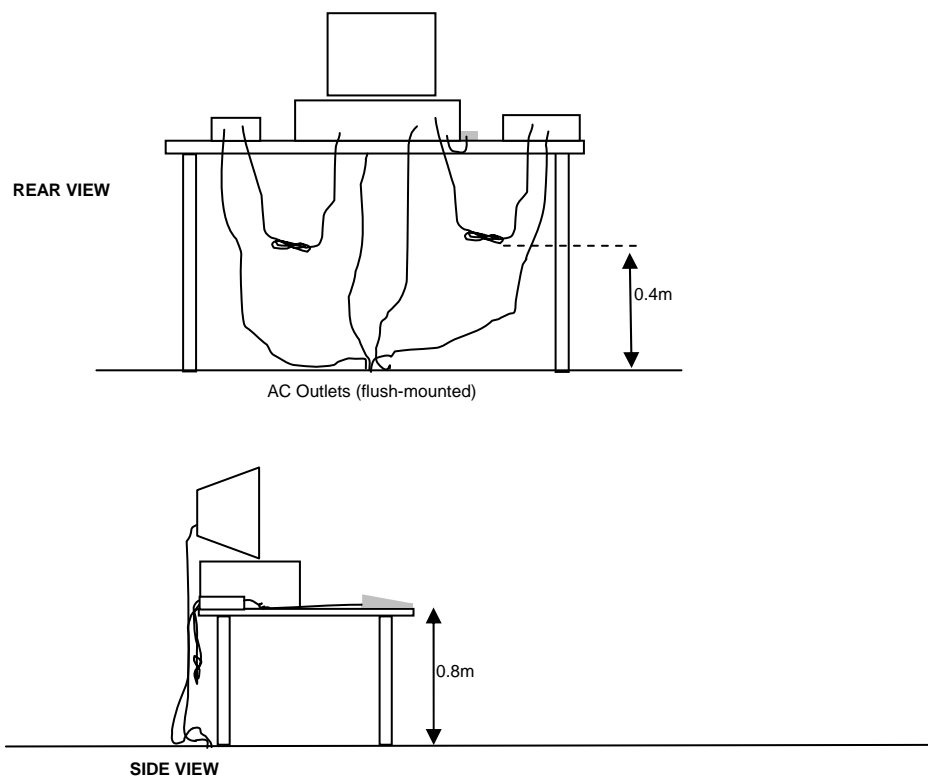

Typical Test Configuration for Radiated Field Strength Measurements

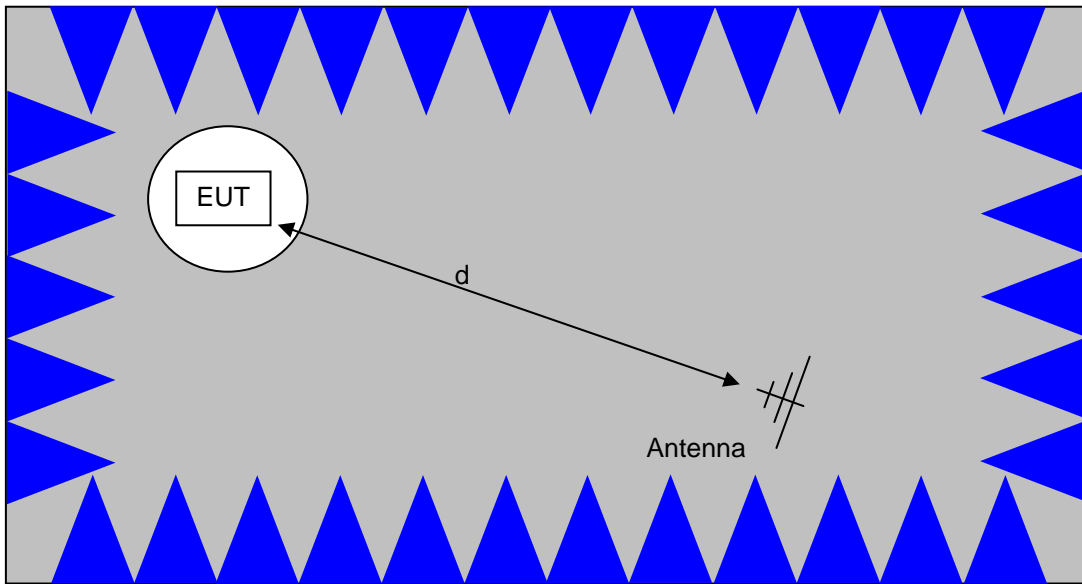

The anechoic materials on the walls and ceiling ensure compliance with the normalized site attenuation requirements of CISPR 16 / CISPR 22 / ANSI C63.4 for an alternate test site at the measurement distances used.

Floor-standing equipment is placed on the floor with insulating supports between the unit and the ground plane.

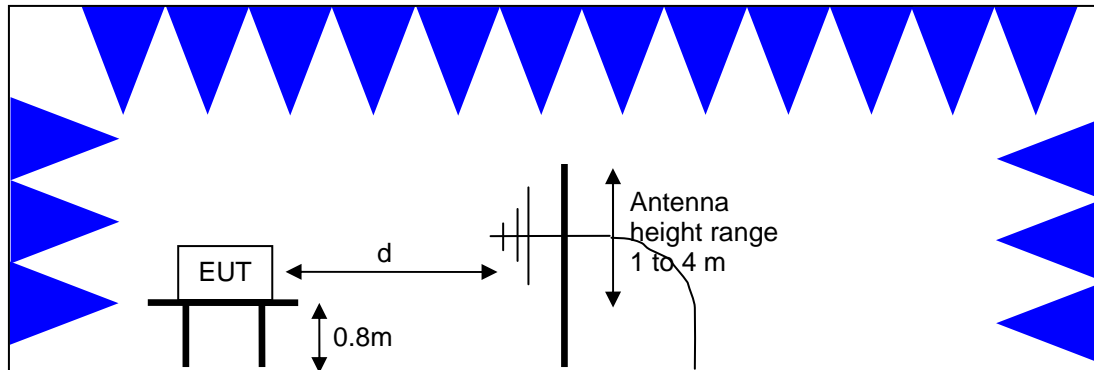

Test Configuration for Radiated Field Strength Measurements
Semi-Anechoic Chamber, Plan and Side Views

CONDUCTED EMISSIONS FROM ANTENNA PORT

Direct measurements of power, bandwidth and power spectral density are performed, where possible, with the antenna port of the EUT connected to either the power meter or spectrum analyzer via a suitable attenuator and/or filter. These are used to ensure that the front end of the measurement instrument is not overloaded by the fundamental transmission.

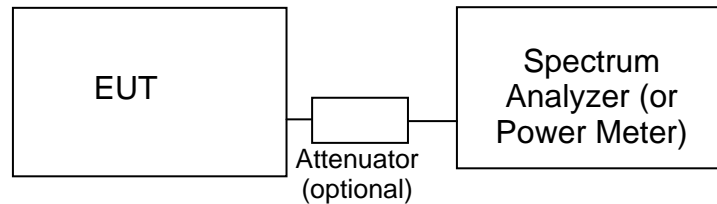
**Test Configuration for Antenna Port Measurements**

Measurement bandwidths (video and resolution) are set in accordance with the relevant standards and Elliott's test procedures for the type of radio being tested. When power measurements are made using a resolution bandwidth less than the signal bandwidth the power is calculated by summing the power across the signal bandwidth using either the analyzer channel power function or by capturing the trace data and calculating the power using software. In both cases the summed power is corrected to account for the equivalent noise bandwidth (ENBW) of the resolution bandwidth used.

If power averaging is used (typically for certain digital modulation techniques), the EUT is configured to transmit continuously. Power averaging is performed using either the built-in function of the analyzer or, if the analyzer does not feature power averaging, using external software. In both cases the average power is calculated over a number of sweeps (typically 100). When the EUT cannot be configured to continuously transmit then either the analyzer is configured to perform a gated sweep to ensure that the power is averaged over periods that the device is transmitting or power averaging is disabled and a max-hold feature is used.

If a power meter is used to make output power measurements the sensor head type (peak or average) is stated in the test data table.

BANDWIDTH MEASUREMENTS

The 6dB, 20dB and/or 26dB signal bandwidth is measured in using the bandwidths recommended by ANSI C63.4. When required, the 99% bandwidth is measured using the methods detailed in RSS GEN.

SPECIFICATION LIMITS AND SAMPLE CALCULATIONS

The limits for conducted emissions are given in units of microvolts, and the limits for radiated emissions are given in units of microvolts per meter at a specified test distance. Data is measured in the logarithmic form of decibels relative to one microvolt, or dB microvolts (dBuV). For radiated emissions, the measured data is converted to the field strength at the antenna in dB microvolts per meter (dBuV/m). The results are then converted to the linear forms of uV and uV/m for comparison to published specifications.

For reference, converting the specification limits from linear to decibel form is accomplished by taking the base ten logarithm, then multiplying by 20. These limits in both linear and logarithmic form are as follows:

CONDUCTED EMISSIONS SPECIFICATION LIMITS: FCC 15.207; FCC 15.107(a), RSS GEN

The table below shows the limits for the emissions on the AC power line from an intentional radiator and a receiver.

Frequency (MHz)	Average Limit (dBuV)	Quasi Peak Limit (dBuV)
0.150 to 0.500	Linear decrease on logarithmic frequency axis between 56.0 and 46.0	Linear decrease on logarithmic frequency axis between 66.0 and 56.0
0.500 to 5.000	46.0	56.0
5.000 to 30.000	50.0	60.0

GENERAL TRANSMITTER RADIATED EMISSIONS SPECIFICATION LIMITS

The table below shows the limits for the spurious emissions from transmitters that fall in restricted bands¹ (with the exception of transmitters operating under FCC Part 15 Subpart D and RSS 210 Annex 9), the limits for all emissions from a low power device operating under the general rules of RSS 310 (tables 3 and 4), RSS 210 (table 2) and FCC Part 15 Subpart C section 15.209.

Frequency Range (MHz)	Limit (uV/m)	Limit (dBuV/m @ 3m)
0.009-0.490	2400/F _{KHz} @ 300m	67.6-20*log ₁₀ (F _{KHz}) @ 300m
0.490-1.705	24000/F _{KHz} @ 30m	87.6-20*log ₁₀ (F _{KHz}) @ 30m
1.705 to 30	30 @ 30m	29.5 @ 30m
30 to 88	100 @ 3m	40 @ 3m
88 to 216	150 @ 3m	43.5 @ 3m
216 to 960	200 @ 3m	46.0 @ 3m
Above 960	500 @ 3m	54.0 @ 3m

RECEIVER RADIATED SPURIOUS EMISSIONS SPECIFICATION LIMITS

The table below shows the limits for the spurious emissions from receivers as detailed in FCC Part 15.109, RSS 210 Table 2, RSS GEN Table 1 and RSS 310 Table 3. Note that receivers operating outside of the frequency range 30 MHz – 960 MHz are exempt from the requirements of 15.109.

Frequency Range (MHz)	Limit (uV/m @ 3m)	Limit (dBuV/m @ 3m)
30 to 88	100	40
88 to 216	150	43.5
216 to 960	200	46.0
Above 960	500	54.0

¹ The restricted bands are detailed in FCC 15.203, RSS 210 Table 1 and RSS 310 Table 2

OUTPUT POWER LIMITS – DIGITAL TRANSMISSION SYSTEMS

The table below shows the limits for output power and output power density. Where the signal bandwidth is less than 20 MHz the maximum output power is reduced to the power spectral density limit plus 10 times the log of the bandwidth (in MHz).

Operating Frequency (MHz)	Output Power	Power Spectral Density
902 – 928	1 Watt (30 dBm)	8 dBm/3kHz
2400 – 2483.5	1 Watt (30 dBm)	8 dBm/3kHz
5725 – 5850	1 Watt (30 dBm)	8 dBm/3kHz

The maximum permitted output power is reduced by 1dB for every dB the antenna gain exceeds 6dBi. Fixed point-to-point applications using the 5725 – 5850 MHz band are not subject to this restriction.

TRANSMIT MODE SPURIOUS RADIATED EMISSIONS LIMITS – FHSS and DTS SYSTEMS

The limits for unwanted (spurious) emissions from the transmitter falling in the restricted bands are those specified in the general limits sections of FCC Part 15 and RSS 210. All other unwanted (spurious) emissions shall be at least 20dB below the level of the highest in-band signal level (30dB if the power is measured using the sample detector/power averaging method).

SAMPLE CALCULATIONS - CONDUCTED EMISSIONS

Receiver readings are compared directly to the conducted emissions specification limit (decibel form) as follows:

$$R_r - S = M$$

where:

R_r = Receiver Reading in dBuV

S = Specification Limit in dBuV

M = Margin to Specification in +/- dB

SAMPLE CALCULATIONS - RADIATED EMISSIONS

Receiver readings are compared directly to the specification limit (decibel form). The receiver internally corrects for cable loss, preamplifier gain, and antenna factor. The calculations are in the reverse direction of the actual signal flow, thus cable loss is added and the amplifier gain is subtracted. The Antenna Factor converts the voltage at the antenna coaxial connector to the field strength at the antenna elements.

A distance factor, when used for electric field measurements above 30MHz, is calculated by using the following formula:

$$F_d = 20 * \text{LOG}_{10} (D_m/D_s)$$

where:

$$F_d = \text{Distance Factor in dB}$$

$$D_m = \text{Measurement Distance in meters}$$

$$D_s = \text{Specification Distance in meters}$$

For electric field measurements below 30MHz the extrapolation factor is either determined by making measurements at multiple distances or a theoretical value is calculated using the formula:

$$F_d = 40 * \text{LOG}_{10} (D_m/D_s)$$

Measurement Distance is the distance at which the measurements were taken and Specification Distance is the distance at which the specification limits are based. The antenna factor converts the voltage at the antenna coaxial connector to the field strength at the antenna elements.

The margin of a given emission peak relative to the limit is calculated as follows:

$$R_c = R_r + F_d$$

and

$$M = R_c - L_s$$

where:

$$R_r = \text{Receiver Reading in dBuV/m}$$

$$F_d = \text{Distance Factor in dB}$$

$$R_c = \text{Corrected Reading in dBuV/m}$$

$$L_s = \text{Specification Limit in dBuV/m}$$

$$M = \text{Margin in dB Relative to Spec}$$

SAMPLE CALCULATIONS - FIELD STRENGTH TO EIRP CONVERSION

Where the radiated electric field strength is expressed in terms of the equivalent isotropic radiated power (eirp), or where a field strength measurement of output power is made in lieu of a direct measurement, the following formula is used to convert between eirp and field strength at a distance of d (meters) from the equipment under test:

$$E = \frac{1000000 \sqrt{30 P}}{d} \quad \text{microvolts per meter}$$

where P is the eirp (Watts)

For a measurement at 3m the conversion from a logarithmic value for field strength (dBuV/m) to an eirp power (dBm) is -95.3dB.

Appendix A Test Equipment Calibration Data**Radiated Emissions, 1000 - 40,000 MHz, 18-May-11**

<u>Manufacturer</u>	<u>Description</u>	<u>Model</u>	<u>Asset #</u>	<u>Cal Due</u>
Hewlett Packard	Microwave Preamplifier, 1-26.5GHz	8449B	785	5/26/2011
EMCO	Antenna, Horn, 1-18 GHz (SA40-Blu)	3115	1386	9/21/2012
Hewlett Packard	SpecAn 9 kHz - 40 GHz, FT (SA40) Blue	8564E (84125C)	1393	6/14/2011
Hewlett Packard	Head (Inc W1-W4, 1742 , 1743) Blue	84125C	1620	5/9/2012
Micro-Tronics	Band Reject Filter, 5725-5875 MHz	BRC50705-02	1682	3/23/2012
A.H. Systems	Blue System Horn, 18-40GHz	SAS-574, p/n: 2581	2159	3/23/2012
Micro-Tronics	Band Reject Filter, 2400-2500 MHz	BRM50702-02	2238	10/1/2011

Radiated Emissions, 1000 - 6,500 MHz, 19-May-11

<u>Manufacturer</u>	<u>Description</u>	<u>Model</u>	<u>Asset #</u>	<u>Cal Due</u>
EMCO	Antenna, Horn, 1-18 GHz (SA40-Blu)	3115	1386	9/21/2012
Hewlett Packard	SpecAn 9 kHz - 40 GHz, FT (SA40) Blue	8564E (84125C)	1393	6/14/2011

Radiated Emissions, 1000 - 18,000 MHz, 20-May-11

<u>Manufacturer</u>	<u>Description</u>	<u>Model</u>	<u>Asset #</u>	<u>Cal Due</u>
Hewlett Packard	Microwave Preamplifier, 1-26.5GHz	8449B	263	12/8/2011
Hewlett Packard	SpecAn 30 Hz -40 GHz, SV (SA40) Red	8564E (84125C)	1148	7/12/2011
EMCO	Antenna, Horn, 1-18 GHz	3115	1561	6/22/2012
Micro-Tronics	Band Reject Filter, 2400-2500 MHz	BRM50702-02	2238	10/1/2011

Radio Antenna Port (Power and Spurious Emissions), 20-May-11

<u>Manufacturer</u>	<u>Description</u>	<u>Model</u>	<u>Asset #</u>	<u>Cal Due</u>
Hewlett Packard	SpecAn 30 Hz -40 GHz, SV (SA40) Red	8564E (84125C)	1148	7/12/2011
Rohde & Schwarz	Power Meter, Single Channel, +1795+1796	NRVS	1534	5/17/2012
Rohde & Schwarz	Power Sensor 100 uW - 2 Watts (w/ 20 dB pad, SN BJ5155)	NRV-Z32	1536	9/13/2011
Rohde & Schwarz	Power Sensor, 1 uW-100 mW, DC-18 GHz, 50ohms	NRV-Z51	2152	11/6/2011

Radiated Spurious Emissions, Rx mode, 1000 - 7,500 MHz, 20-May-11

<u>Manufacturer</u>	<u>Description</u>	<u>Model</u>	<u>Asset #</u>	<u>Cal Due</u>
Hewlett Packard	Microwave Preamplifier, 1-26.5GHz	8449B	263	12/8/2011
Hewlett Packard	SpecAn 30 Hz -40 GHz, SV (SA40) Red	8564E (84125C)	1148	7/12/2011
EMCO	Antenna, Horn, 1-18 GHz	3115	1561	6/22/2012

Radiated Emissions, 1000 - 40000MHz, 20-Dec-11

<u>Manufacturer</u>	<u>Description</u>	<u>Model</u>	<u>Asset #</u>	<u>Cal Due</u>
Hewlett Packard	Microwave Preamplifier, 1-26.5GHz	8449B	263	12/9/2012
EMCO	Antenna, Horn, 1-18 GHz (SA40-Red)	3115	1142	8/2/2012
Hewlett Packard	SpecAn 30 Hz -40 GHz, SV (SA40) Red	8564E (84125C)	1148	8/15/2012

Radio Antenna Port (Power and Spurious Emissions), 07-Feb-12

<u>Manufacturer</u>	<u>Description</u>	<u>Model</u>	<u>Asset #</u>	<u>Cal Due</u>
Agilent	PSA, Spectrum Analyzer, (installed options, 111, 115, 123, 1DS, B7J, HYX,	E4446A	2139	2/14/2012

Conducted Emissions - AC Power Ports, 16-Dec-11

<u>Manufacturer</u>	<u>Description</u>	<u>Model</u>	<u>Asset #</u>	<u>Cal Due</u>
EMCO	LISN, 10 kHz-100 MHz, 25A	3825/2	1292	3/1/2012
Rohde & Schwarz	EMI Test Receiver, 20 Hz-7 GHz	ESIB7	1756	4/6/2012

Appendix B Test Data

T83195 Pages 27 – 84

T83198 Pages 85 - 93

Client:	Summit Data Communications	Job Number:	J78403
Model:	SDC-MSD40NBT (1x1 802.11abg + BT 2.1)	T-Log Number:	T83195
		Account Manager:	Christine Krebill
Contact:	Ron Seide		-
Emissions Standard(s):	FCC 15.247/RSS-210	Class:	-
Immunity Standard(s):	-	Environment:	-

EMC Test Data

For The

Summit Data Communications

Model

SDC-MSD40NBT (1x1 802.11abg + BT 2.1)

Date of Last Test:

Client:	Summit Data Communications	Job Number:	J78403
Model:	SDC-MSD40NBT (1x1 802.11abg + BT 2.1)	T-Log Number:	T83195
Contact:	Ron Seide	Account Manager:	Christine Krebill
Standard:	FCC 15.247/RSS-210	Class:	N/A

RSS 210 and FCC 15.247 (DTS) Radiated Spurious Emissions

Summary of Results - Device Operating in the 2400-2483.5 MHz Band

SCU:

Run #	Mode	Channel	Antenna	Power Setting	Test Performed	Limit	Result / Margin
Run #1	802.11b Chain A	#1 2412MHz	Cisco	-	Restricted Band Edge at 2390 MHz	15.209	47.0dBµV/m @ 2381.6MHz (-7.0dB)
		#11 2462MHz	Cisco	-	Restricted Band Edge at 2483.5 MHz	15.209	46.2dBµV/m @ 2497.9MHz (-7.8dB)
Run # 2	802.11g Chain A	#1 2412MHz	Cisco	-	Restricted Band Edge at 2390 MHz	15.209	53.2dBµV/m @ 2389.9MHz (-0.8dB)
		#11 2462MHz	Cisco	-	Restricted Band Edge at 2483.5 MHz	15.209	50.5dBµV/m @ 2483.5MHz (-3.5dB)
Run # 3	802.11n20 Chain A	#1 2412MHz	Cisco	-	Restricted Band Edge at 2390 MHz	15.209	53.3dBµV/m @ 2389.7MHz (-0.7dB)
		#11 2462MHz	Cisco	-	Restricted Band Edge at 2483.5 MHz	15.209	50.9dBµV/m @ 2483.5MHz (-3.1dB)

Test Specific Details

Objective: The objective of this test session is to perform final qualification testing of the EUT with respect to the specification listed above.

General Test Configuration

The EUT and all local support equipment were located on the turntable for radiated spurious emissions testing. For radiated emissions testing the measurement antenna was located 3 meters from the EUT.

Ambient Conditions:

Temperature: 20-25 °C
Rel. Humidity: 40-50 %

Modifications Made During Testing

No modifications were made to the EUT during testing

Deviations From The Standard

No deviations were made from the requirements of the standard.

Client:	Summit Data Communications	Job Number:	J78403
Model:	SDC-MSD40NBT (1x1 802.11abg + BT 2.1)	T-Log Number:	T83195
Contact:	Ron Seide	Account Manager:	Christine Krebill
Standard:	FCC 15.247/RSS-210	Class:	N/A

Run #1, Band Edge Field Strength - 802.11b, Chain A

Date of Test: 5/18/2011

Test Location: FT Chamber #7

Test Engineer: Rafael Varelas

Config Change: None

Run #1a, EUT on Channel #1 2412MHz - 802.11b, Chain A

2390 MHz Band Edge Signal Field Strength

Frequency	Level	Pol	15.209 / 15.247		Detector	Azimuth	Height	Comments
MHz	dB μ V/m	v/h	Limit	Margin	Pk/QP/Avg	degrees	meters	
2381.600	47.0	V	54.0	-7.0	AVG	0	1.0	RB 1 MHz;VB 10 Hz;Pk
2382.600	56.8	V	74.0	-17.2	PK	0	1.0	RB 1 MHz;VB 3 MHz;Pk
2378.470	44.7	H	54.0	-9.3	AVG	112	1.9	RB 1 MHz;VB 10 Hz;Pk
2386.730	56.2	H	74.0	-17.8	PK	112	1.9	RB 1 MHz;VB 3 MHz;Pk

RB 1 MHz; VB 10 Hz (Black Trace) Avg, (Blue Trace) Pk, Vertical

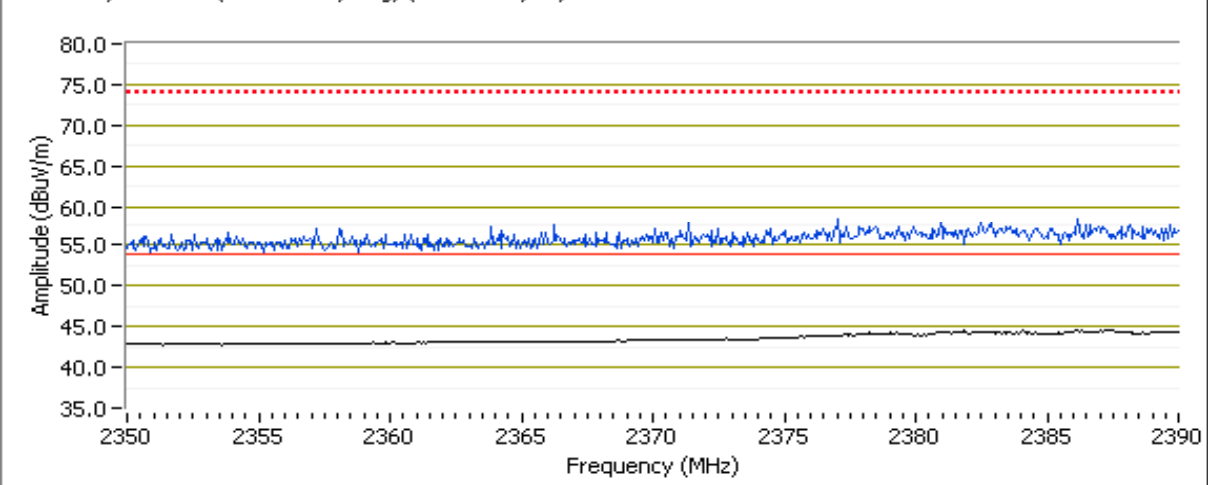

Client:	Summit Data Communications	Job Number:	J78403
Model:	SDC-MSD40NBT (1x1 802.11abg + BT 2.1)	T-Log Number:	T83195
Contact:	Ron Seide	Account Manager:	Christine Krebill
Standard:	FCC 15.247/RSS-210	Class:	N/A

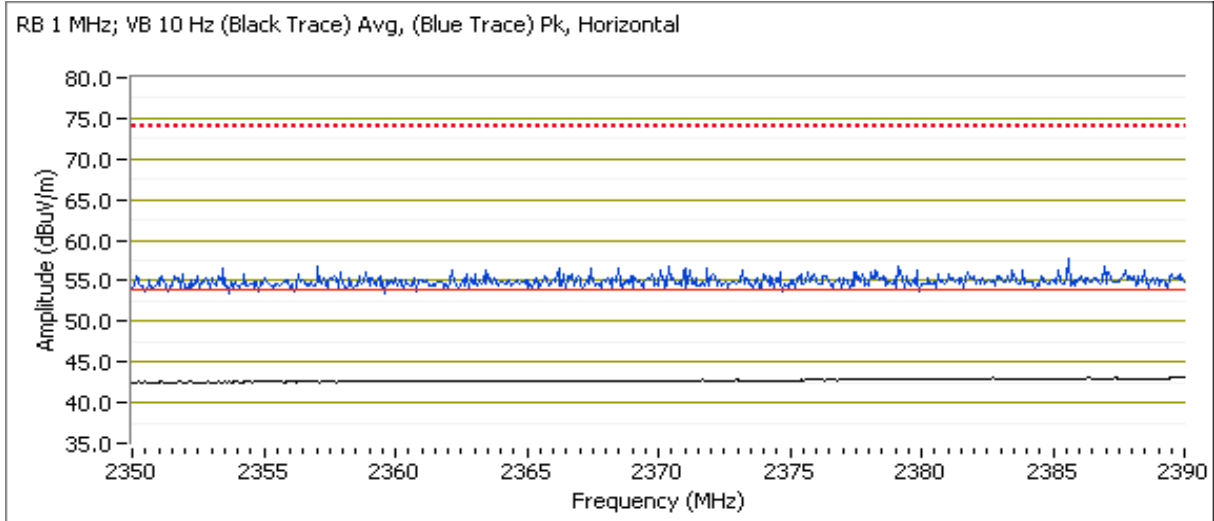

Client:	Summit Data Communications	Job Number:	J78403
Model:	SDC-MSD40NBT (1x1 802.11abg + BT 2.1)	T-Log Number:	T83195
Contact:	Ron Seide	Account Manager:	Christine Krebill
Standard:	FCC 15.247/RSS-210	Class:	N/A

Run #1b, EUT on Channel #11 2462MHz - 802.11b, Chain A

2483.5 MHz Band Edge Signal Radiated Field Strength

Frequency	Level	Pol	15.209 / 15.247		Detector	Azimuth	Height	Comments
MHz	dB μ V/m	v/h	Limit	Margin	PK/QP/Avg	degrees	meters	
2497.910	46.2	V	54.0	-7.8	AVG	310	1.0	RB 1 MHz;VB 10 Hz;Pk
2486.250	57.0	V	74.0	-17.0	PK	310	1.0	RB 1 MHz;VB 3 MHz;Pk
2499.200	45.6	H	54.0	-8.4	AVG	94	1.7	RB 1 MHz;VB 10 Hz;Pk
2497.960	56.9	H	74.0	-17.1	PK	94	1.7	RB 1 MHz;VB 3 MHz;Pk

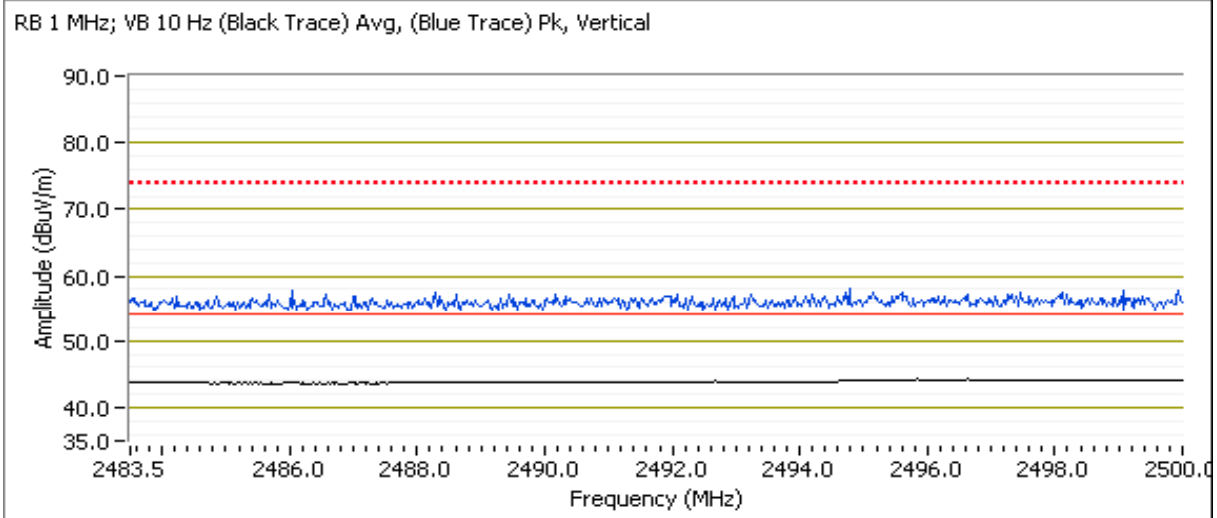

Client:	Summit Data Communications	Job Number:	J78403
Model:	SDC-MSD40NBT (1x1 802.11abg + BT 2.1)	T-Log Number:	T83195
Contact:	Ron Seide	Account Manager:	Christine Krebill
Standard:	FCC 15.247/RSS-210	Class:	N/A

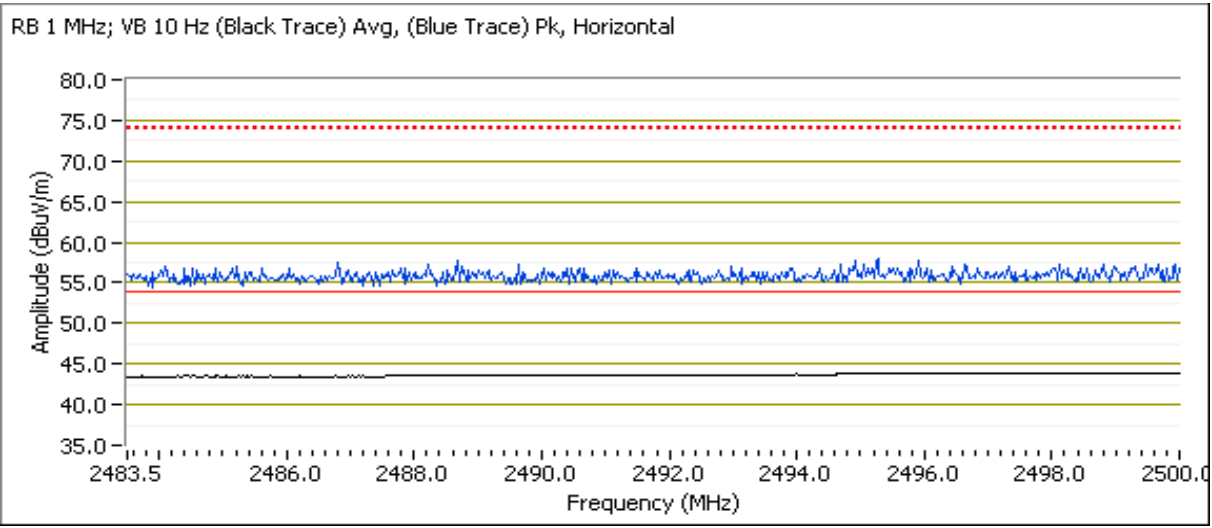

Client:	Summit Data Communications	Job Number:	J78403
Model:	SDC-MSD40NBT (1x1 802.11abg + BT 2.1)	T-Log Number:	T83195
Contact:	Ron Seide	Account Manager:	Christine Krebill
Standard:	FCC 15.247/RSS-210	Class:	N/A

Run # 2, Band Edge Field Strength - 802.11g, Chain A

Run # 2a, EUT on Channel #1 2412MHz - 802.11g, Chain A

Date of Test: 12/16/2011
 Test Engineer: Rafael Varelas

Test Location: FT Chamber #4
 Config Change: None

2390 MHz Band Edge Signal Field Strength

Frequency	Level	Pol	15.209 / 15.247		Detector	Azimuth	Height	Comments
MHz	dB μ V/m	v/h	Limit	Margin	Pk/QP/Avg	degrees	meters	
2389.870	53.2	V	54.0	-0.8	AVG	6	1.3	RB 1 MHz;VB 10 Hz;Pk, 97%
2389.930	65.9	V	74.0	-8.1	PK	6	1.3	RB 1 MHz;VB 3 MHz;Pk, 97%
2390.000	48.4	H	54.0	-5.6	AVG	179	1.2	RB 1 MHz;VB 10 Hz;Pk, 97%
2389.470	59.4	H	74.0	-14.6	PK	179	1.2	RB 1 MHz;VB 3 MHz;Pk, 97%

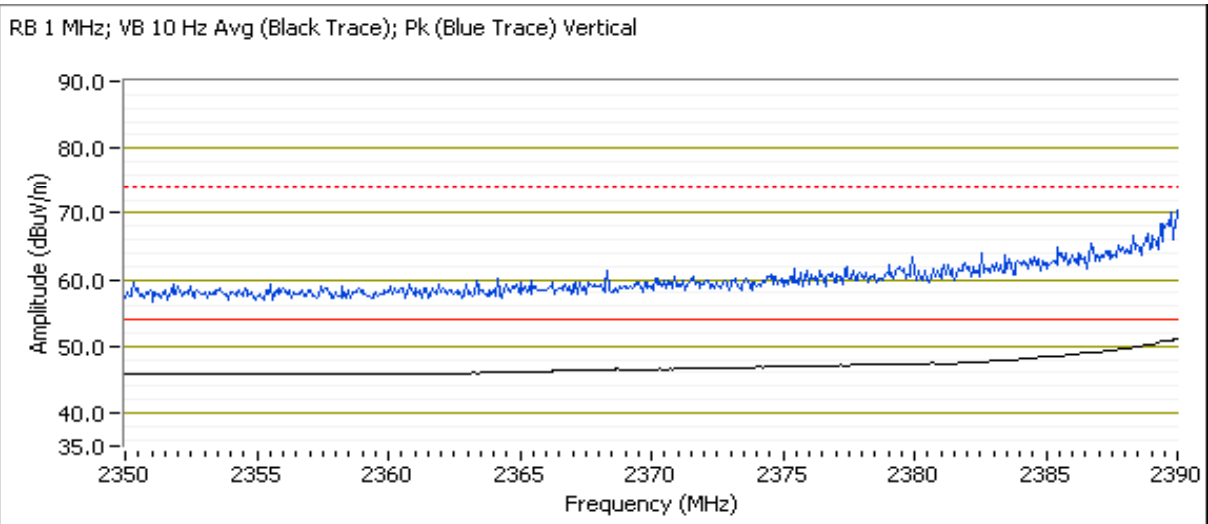

Client:	Summit Data Communications	Job Number:	J78403
Model:	SDC-MSD40NBT (1x1 802.11abg + BT 2.1)	T-Log Number:	T83195
Contact:	Ron Seide	Account Manager:	Christine Krebill
Standard:	FCC 15.247/RSS-210	Class:	N/A

Run # 2b, EUT on Channel #11 2462MHz - 802.11g, Chain A

Date of Test: 5/19/2011

Test Location: FT Chamber #7

Test Engineer: Rafael Varelas & David Bare

Config Change: None

2483.5 MHz Band Edge Signal Radiated Field Strength

Frequency MHz	Level dB μ V/m	Pol v/h	15.209 / 15.247		Detector Pk/QP/Avg	Azimuth degrees	Height meters	Comments
			Limit	Margin				
2483.500	50.5	V	54.0	-3.5	AVG	285	1.0	RB 1 MHz;VB 10 Hz;Pk
2484.300	61.9	V	74.0	-12.1	PK	285	1.0	RB 1 MHz;VB 3 MHz;Pk
2496.310	47.4	H	54.0	-6.6	AVG	193	1.1	RB 1 MHz;VB 10 Hz;Pk
2489.440	58.4	H	74.0	-15.6	PK	193	1.1	RB 1 MHz;VB 3 MHz;Pk

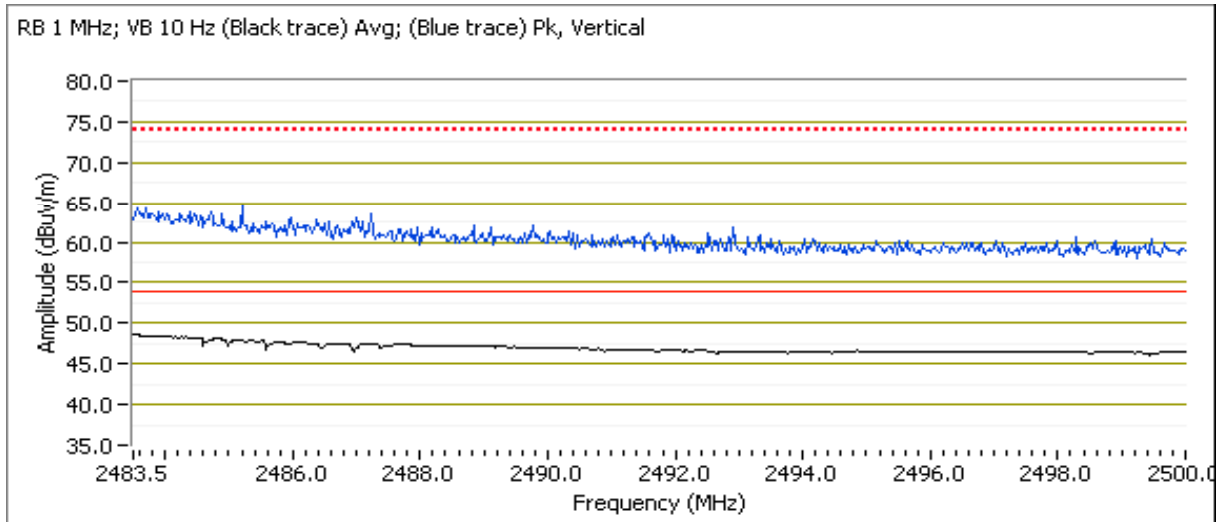

Client:	Summit Data Communications	Job Number:	J78403
Model:	SDC-MSD40NBT (1x1 802.11abg + BT 2.1)	T-Log Number:	T83195
Contact:	Ron Seide	Account Manager:	Christine Krebill
Standard:	FCC 15.247/RSS-210	Class:	N/A

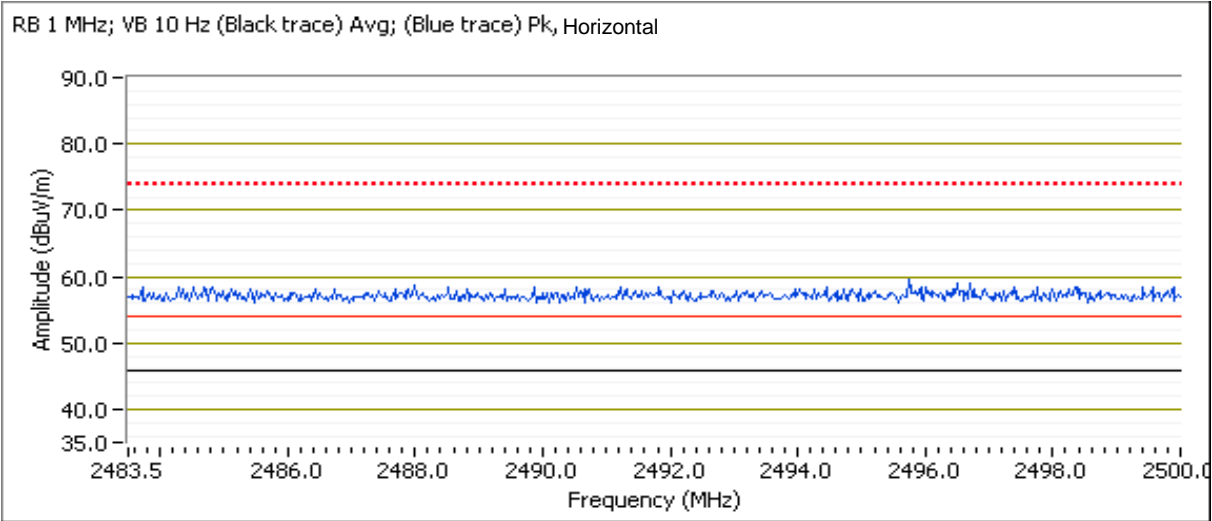

Client:	Summit Data Communications	Job Number:	J78403
Model:	SDC-MSD40NBT (1x1 802.11abg + BT 2.1)	T-Log Number:	T83195
Contact:	Ron Seide	Account Manager:	Christine Krebill
Standard:	FCC 15.247/RSS-210	Class:	N/A

Run # 3, Band Edge Field Strength - 802.11n20

Run # 3a, EUT on Channel #1 2412MHz - 802.11n20

Date of Test: 12/20/2011
Test Engineer: Rafael Varelas

Test Location: FT Chamber #4
Config Change: none

2390 MHz Band Edge Signal Field Strength

Frequency	Level	Pol	15.209 / 15.247		Detector	Azimuth	Height	Comments
MHz	dB μ V/m	v/h	Limit	Margin	Pk/QP/Avg	degrees	meters	
2389.730	53.3	V	54.0	-0.7	AVG	253	1.0	RB 1 MHz;VB 10 Hz;Pk
2389.530	66.8	V	74.0	-7.2	PK	253	1.0	RB 1 MHz;VB 3 MHz;Pk
2389.930	47.4	H	54.0	-6.6	AVG	251	1.1	RB 1 MHz;VB 10 Hz;Pk
2388.930	58.3	H	74.0	-15.7	PK	251	1.1	RB 1 MHz;VB 3 MHz;Pk

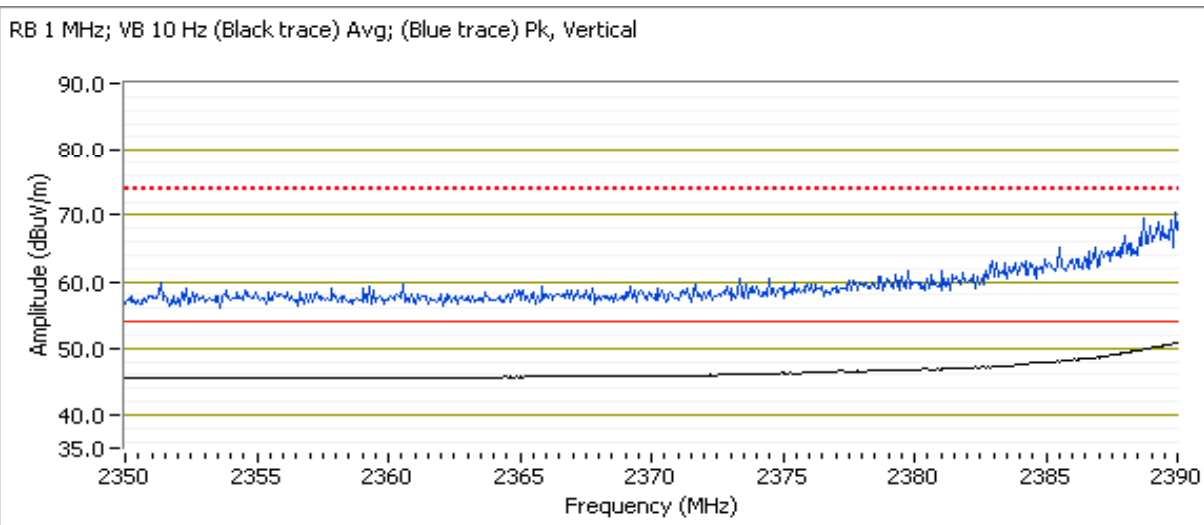

Client:	Summit Data Communications	Job Number:	J78403
Model:	SDC-MSD40NBT (1x1 802.11abg + BT 2.1)	T-Log Number:	T83195
Contact:	Ron Seide	Account Manager:	Christine Krebill
Standard:	FCC 15.247/RSS-210	Class:	N/A

Run # 3b, EUT on Channel #11 2462MHz - 802.11n20

Date of Test: 5/19/2011
Test Engineer: David Bare

Test Location: FT Chamber #7
Config Change: none

2483.5 MHz Band Edge Signal Radiated Field Strength

Frequency	Level	Pol	15.209 / 15.247		Detector	Azimuth	Height	Comments
MHz	dB μ V/m	v/h	Limit	Margin	Pk/QP/Avg	degrees	meters	
2483.500	50.9	V	54.0	-3.1	AVG	283	1.0	RB 1 MHz;VB 10 Hz;Pk
2483.510	66.1	V	74.0	-7.9	PK	283	1.0	RB 1 MHz;VB 3 MHz;Pk
2484.530	47.6	H	54.0	-6.4	AVG	193	1.1	RB 1 MHz;VB 10 Hz;Pk
2484.180	58.2	H	74.0	-15.8	PK	193	1.1	RB 1 MHz;VB 3 MHz;Pk

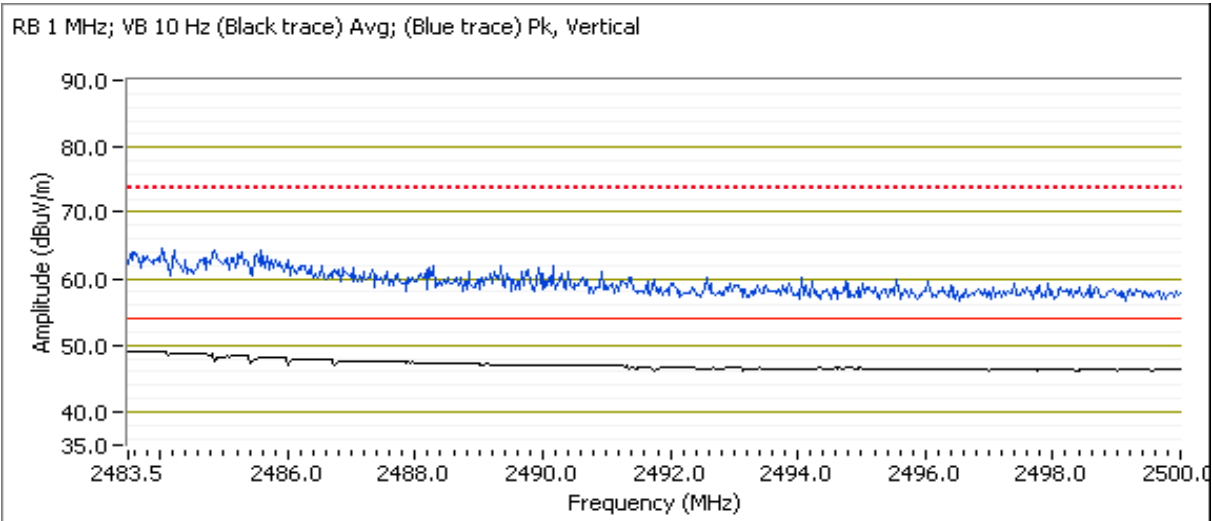

Client:	Summit Data Communications	Job Number:	J78403
Model:	SDC-MSD40NBT (1x1 802.11abg + BT 2.1)	T-Log Number:	T83195
Contact:	Ron Seide	Account Manager:	Christine Krebill
Standard:	FCC 15.247/RSS-210	Class:	N/A

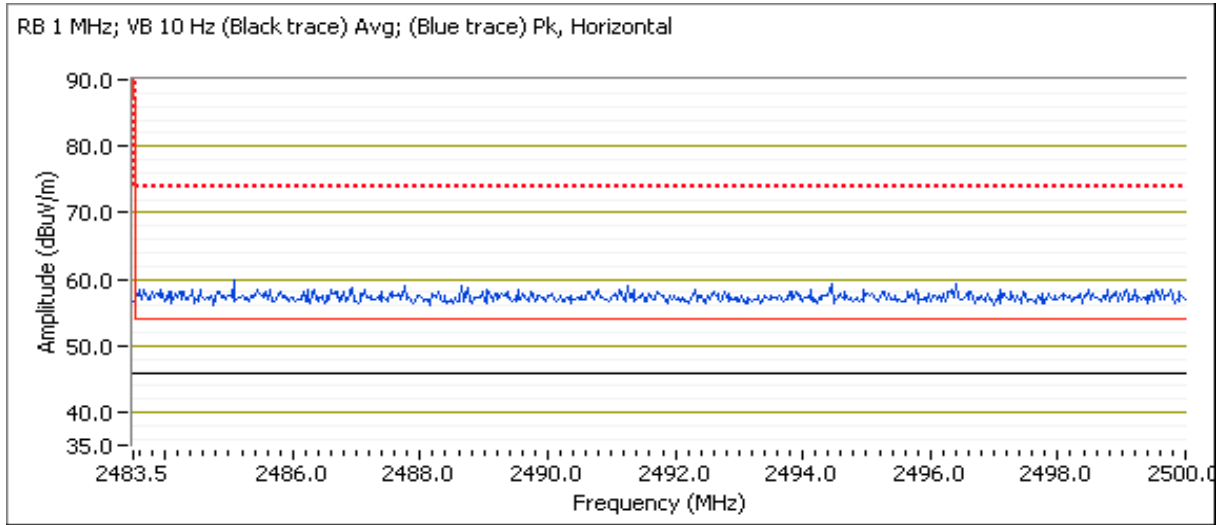

Client:	Summit Data Communications	Job Number:	J78403
Model:	SDC-MSD40NBT (1x1 802.11abg + BT 2.1)	T-Log Number:	T83195
Contact:	Ron Seide	Account Manager:	Christine Krebill
Standard:	FCC 15.247/RSS-210	Class:	N/A

RSS 210 and FCC 15.247 (DTS) Radiated Spurious Emissions

Summary of Results - Device Operating in the 2400-2483.5 MHz Band

SCU:

Run #	Mode	Channel	Antenna	Power Setting	Test Performed	Limit	Result / Margin
Run #1	802.11b Chain A	#1 2412MHz	Cisco	-	Radiated Emissions, 1 - 26 GHz	FCC 15.209 / 15.247	52.4dBµV/m @ 4823.9MHz (-1.6dB)
		#6 2437MHz	Cisco	-			50.7dBµV/m @ 4874.0MHz (-3.3dB)
		#11 2462MHz	Cisco	-			46.1dBµV/m @ 3282.7MHz (-7.9dB)

Scans on center channel in all three OFDM modes to determine the worst case

Run # 2	802.11g Chain A	#6 2437MHz	Cisco	-	Radiated Emissions, 1 - 26 GHz	FCC 15.209 / 15.247	46.8dBµV/m @ 3249.3MHz (-7.2dB)
	802.11n20 Chain A	#6 2437MHz	Cisco	-			46.2dBµV/m @ 3249.3MHz (-7.8dB)

Top and bottom channels in worst case OFDM mode:

Run # 3	802.11n20 Chain A	#1 2412MHz	Cisco	-	Radiated Emissions, 1 - 26 GHz	FCC 15.209 / 15.247	46.0dBµV/m @ 3216.0MHz (-8.0dB)
		#11 2462MHz	Cisco	-			46.2dBµV/m @ 3282.7MHz (-7.8dB)

Receiver Spurious Emissions

Run # 4	Receive	#6, Chain A	Cisco	NA	Radiated Emissions, 1 - 7.5 GHz	RSS 210	46.5dBµV/m @ 3249.4MHz (-7.5dB)
---------	---------	-------------	-------	----	------------------------------------	---------	------------------------------------

Test Specific Details

Objective: The objective of this test session is to perform final qualification testing of the EUT with respect to the specification listed above.

General Test Configuration

The EUT and all local support equipment were located on the turntable for radiated spurious emissions testing. For radiated emissions testing the measurement antenna was located 3 meters from the EUT.

Ambient Conditions: Temperature: 20-25 °C
Rel. Humidity: 40-50 %

Client:	Summit Data Communications	Job Number:	J78403
Model:	SDC-MSD40NBT (1x1 802.11abg + BT 2.1)	T-Log Number:	T83195
Contact:	Ron Seide	Account Manager:	Christine Krebill
Standard:	FCC 15.247/RSS-210	Class:	N/A

Modifications Made During Testing

No modifications were made to the EUT during testing

Deviations From The Standard

No deviations were made from the requirements of the standard.

Run #1, Radiated Spurious Emissions, 1-26GHz, 802.11b, Chain A

Date of Test: 5/19/2011

Test Location: FT#7

Test Engineer: Mark Hill

Config Change: -

Run #1a, EUT on Channel #1 2412MHz - 802.11b, Chain A

Spurious Radiated Emissions:

Frequency MHz	Level dB μ V/m	Pol v/h	15.209/15.247		Detector Pk/QP/Avg	Azimuth degrees	Height meters	Comments
			Limit	Margin				
4823.890	52.4	V	54.0	-1.6	AVG	38	1.8	RB 1 MHz;VB 10 Hz;Pk
4823.940	55.3	V	74.0	-18.7	PK	38	1.8	RB 1 MHz;VB 3 MHz;Pk
1891.420	29.2	V	54.0	-24.8	AVG	322	1.0	RB 1 MHz;VB 10 Hz;Pk, note 2
1870.360	40.9	V	74.0	-33.1	PK	322	1.0	RB 1 MHz;VB 3 MHz;Pk, note 2
3216.020	47.5	H	54.0	-6.5	AVG	246	1.0	RB 1 MHz;VB 10 Hz;Pk, note 2
3215.910	50.2	H	74.0	-23.8	PK	246	1.0	RB 1 MHz;VB 3 MHz;Pk, note 2

Note 1: For emissions in restricted bands, the limit of 15.209 was used. For all other emissions, the limit is -30dBc for peak measurements in a measurement bandwidth of 100kHz.

Note 2: Restricted band limit used for non-restricted band emission.

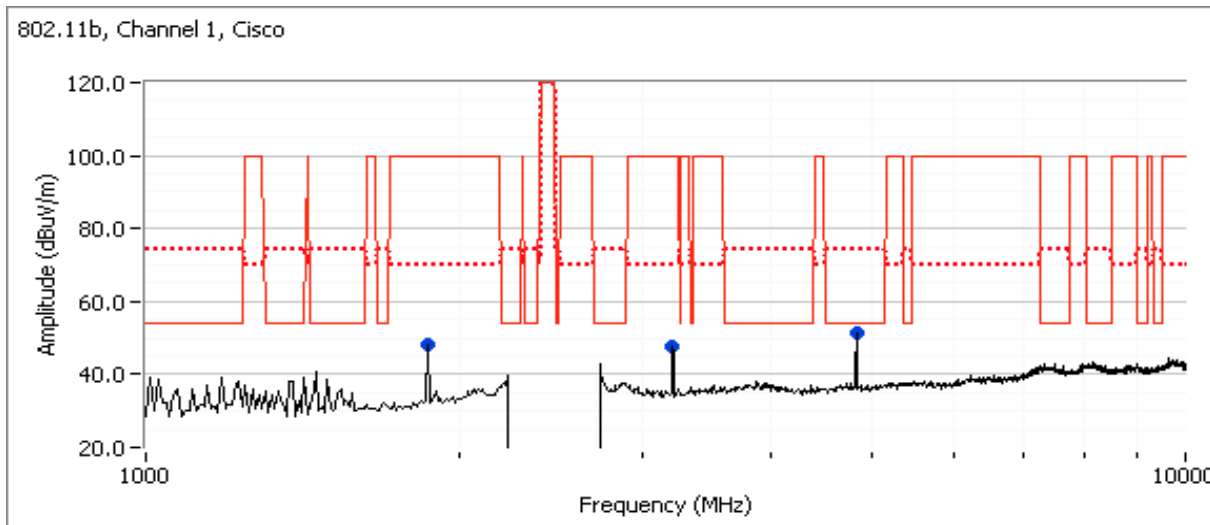

Client:	Summit Data Communications	Job Number:	J78403
Model:	SDC-MSD40NBT (1x1 802.11abg + BT 2.1)	T-Log Number:	T83195
Contact:	Ron Seide	Account Manager:	Christine Krebill
Standard:	FCC 15.247/RSS-210	Class:	N/A

Run #1b: , EUT on Channel #6 2437MHz - 802.11b, Chain A

Spurious Radiated Emissions:

Frequency	Level	Pol	15.209/15.247		Detector	Azimuth	Height	Comments
MHz	dB μ V/m	v/h	Limit	Margin	PK/QP/Avg	degrees	meters	
4873.990	50.7	V	54.0	-3.3	AVG	78	1.0	RB 1 MHz;VB 10 Hz;Pk
4874.000	53.7	V	74.0	-20.3	PK	78	1.0	RB 1 MHz;VB 3 MHz;Pk
3249.330	46.9	H	54.0	-7.1	AVG	256	1.0	RB 1 MHz;VB 10 Hz;Pk., note 2
3249.370	50.0	H	74.0	-24.0	PK	256	1.0	RB 1 MHz;VB 3 MHz;Pk, note 2

- Note 1: For emissions in restricted bands, the limit of 15.209 was used. For all other emissions, the limit is -30dBc for peak measurements in a measurement bandwidth of 100kHz.
- Note 2: Restricted band limit used for non-restricted band emission.
- Note 3: Scans made between 10 - 26GHz with the measurement antenna moved around the card and its antennas 20-50cm from the device indicated there were no significant emissions in this frequency range

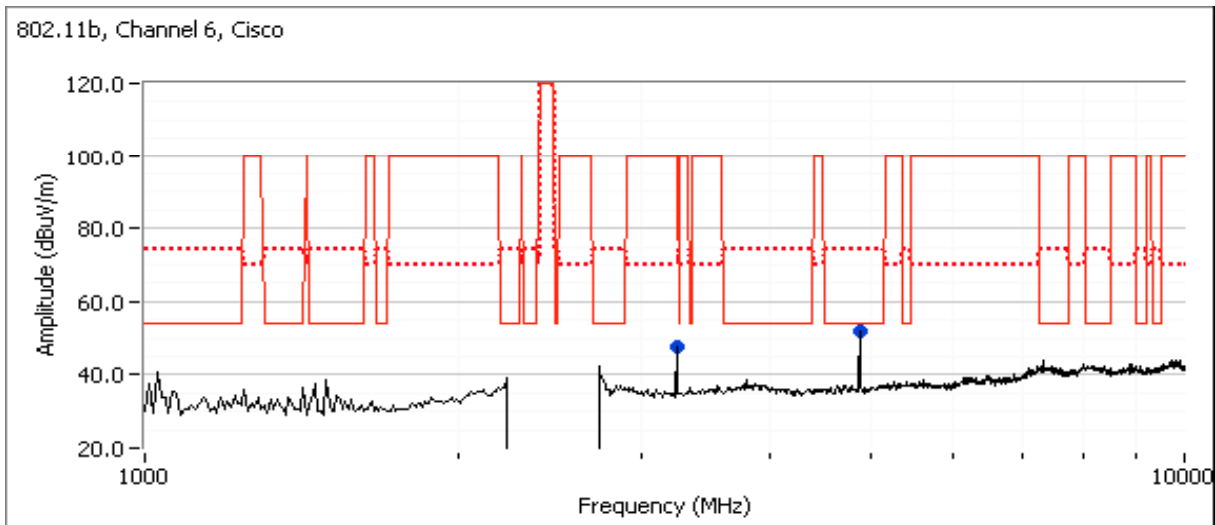

Client:	Summit Data Communications	Job Number:	J78403
Model:	SDC-MSD40NBT (1x1 802.11abg + BT 2.1)	T-Log Number:	T83195
Contact:	Ron Seide	Account Manager:	Christine Krebill
Standard:	FCC 15.247/RSS-210	Class:	N/A

Run #1c: , EUT on Channel #11 2462MHz - 802.11b, Chain A

Spurious Radiated Emissions:

Frequency	Level	Pol	15.209/15.247		Detector	Azimuth	Height	Comments
MHz	dB μ V/m	v/h	Limit	Margin	PK/QP/Avg	degrees	meters	
3282.670	46.1	H	54.0	-7.9	AVG	255	1.0	RB 1 MHz;VB 10 Hz;Pk, note 2
3282.710	49.8	H	74.0	-24.2	PK	255	1.0	RB 1 MHz;VB 3 MHz;Pk, note 2
4923.970	45.6	V	54.0	-8.4	AVG	80	1.1	RB 1 MHz;VB 10 Hz;Pk
4924.170	49.9	V	74.0	-24.1	PK	80	1.1	RB 1 MHz;VB 3 MHz;Pk

Note 1: For emissions in restricted bands, the limit of 15.209 was used. For all other emissions, the limit is -30dBc for peak measurements in a measurement bandwidth of 100kHz.

Note 2: Restricted band limit used for non-restricted band emission.

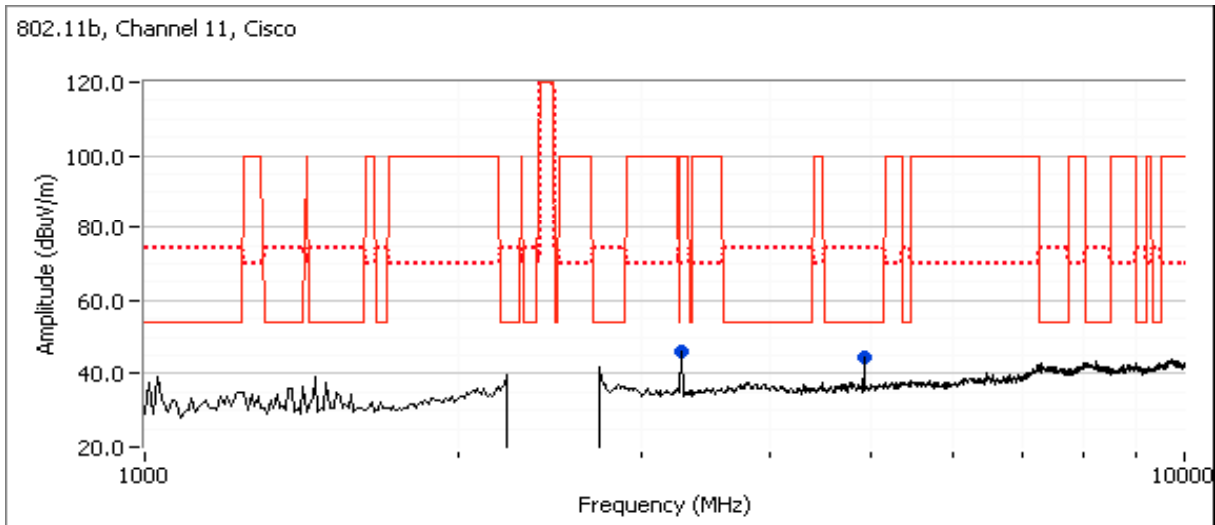

Client:	Summit Data Communications	Job Number:	J78403
Model:	SDC-MSD40NBT (1x1 802.11abg + BT 2.1)	T-Log Number:	T83195
Contact:	Ron Seide	Account Manager:	Christine Krebill
Standard:	FCC 15.247/RSS-210	Class:	N/A

Run # 2, Radiated Spurious Emissions, 1-26GHz, 802.11g, 802.11n20, Chain A
 Date of Test: 5/19/2011 Test Location: FT#7
 Test Engineer: Mark Hill Config Change: -
 Run # 2a, EUT on Channel #6 2437MHz - 802.11g, Chain A

Spurious Radiated Emissions:

Frequency	Level	Pol	15.209/15.247		Detector	Azimuth	Height	Comments
MHz	dB μ V/m	v/h	Limit	Margin	Pk/QP/Avg	degrees	meters	
3249.340	46.8	H	54.0	-7.2	AVG	261	1.0	RB 1 MHz;VB 10 Hz;Pk, note 2
3249.440	50.0	H	74.0	-24.0	PK	261	1.0	RB 1 MHz;VB 3 MHz;Pk, note 2
4874.170	39.9	V	54.0	-14.1	AVG	194	1.0	RB 1 MHz;VB 10 Hz;Pk
4875.500	50.8	V	74.0	-23.2	PK	194	1.0	RB 1 MHz;VB 3 MHz;Pk

- Note 1: For emissions in restricted bands, the limit of 15.209 was used. For all other emissions, the limit is -30dBc for peak measurements in a measurement bandwidth of 100kHz.
 Note 2: Restricted band limit used for non-restricted band emission.

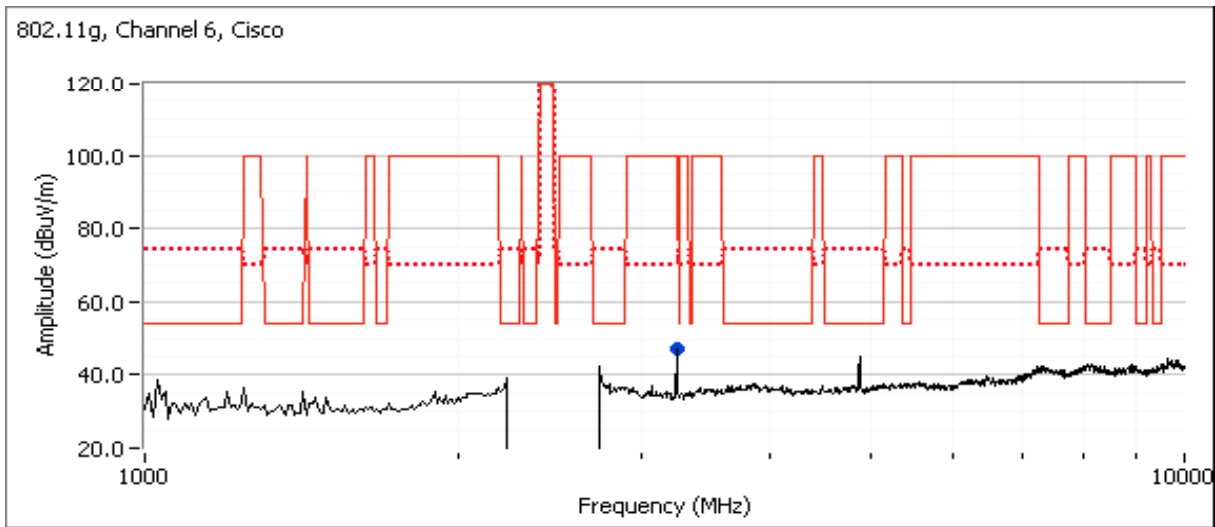

Client:	Summit Data Communications	Job Number:	J78403
Model:	SDC-MSD40NBT (1x1 802.11abg + BT 2.1)	T-Log Number:	T83195
Contact:	Ron Seide	Account Manager:	Christine Krebill
Standard:	FCC 15.247/RSS-210	Class:	N/A

Run # 2b: , EUT on Channel #6 2437MHz - 802.11n20, Chain A

Spurious Radiated Emissions:

Frequency	Level	Pol	15.209/15.247		Detector	Azimuth	Height	Comments
MHz	dB μ V/m	v/h	Limit	Margin	Pk/QP/Avg	degrees	meters	
3249.340	46.2	H	54.0	-7.8	AVG	256	1.0	RB 1 MHz;VB 10 Hz;Pk, note 3
3249.330	49.5	H	74.0	-24.5	PK	256	1.0	RB 1 MHz;VB 3 MHz;Pk, note 3
4873.800	41.2	V	54.0	-12.8	AVG	43	1.1	RB 1 MHz;VB 10 Hz;Pk
4874.440	52.5	V	74.0	-21.5	PK	43	1.1	RB 1 MHz;VB 3 MHz;Pk

- Note 1: For emissions in restricted bands, the limit of 15.209 was used. For all other emissions, the limit is -30dBc for peak measurements in a measurement bandwidth of 100kHz.
- Note 2: Scans made between 10 - 26GHz with the measurement antenna moved around the card and its antennas 20-50cm from the device indicated there were no significant emissions in this frequency range
- Note 3: Restricted band limit used for non-restricted band emission.

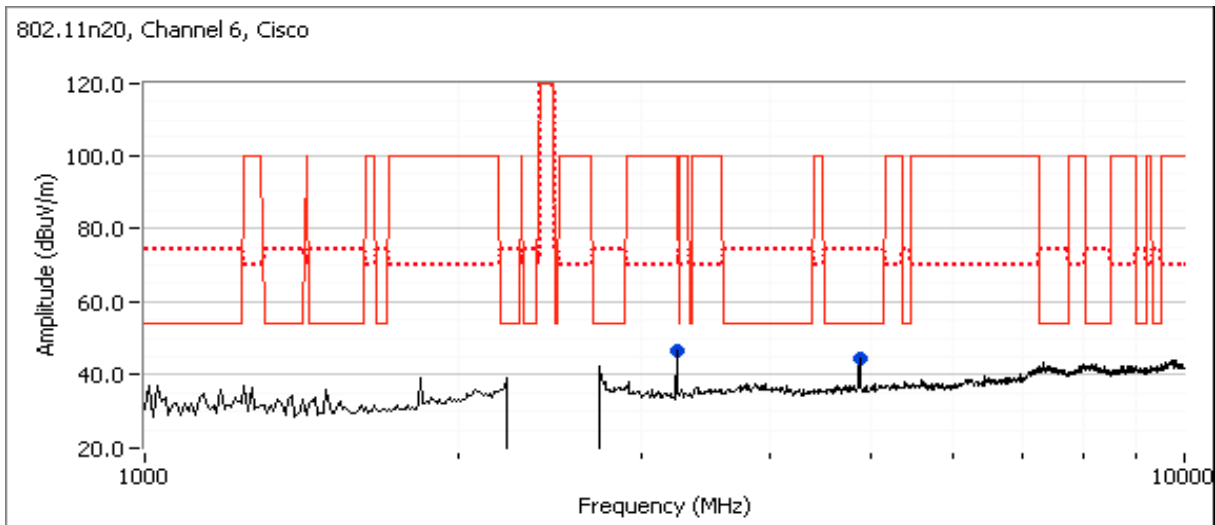

Client:	Summit Data Communications	Job Number:	J78403
Model:	SDC-MSD40NBT (1x1 802.11abg + BT 2.1)	T-Log Number:	T83195
Contact:	Ron Seide	Account Manager:	Christine Krebill
Standard:	FCC 15.247/RSS-210	Class:	N/A

Run # 3, Radiated Spurious Emissions, 1-26GHz, 802.11n20 MCS0, Chain A

Date of Test: 5/19/2011

Test Location: FT Chamber #7

Test Engineer: Rafael Varelas

Config Change: None

Run # 3a, EUT on Channel #1 2412MHz - 802.11n20 MCS0, Chain A

Spurious Radiated Emissions:

Frequency	Level	Pol	15.209/15.247		Detector	Azimuth	Height	Comments
MHz	dB μ V/m	v/h	Limit	Margin	Pk/QP/Avg	degrees	meters	
3216.000	46.0	H	54.0	-8.0	AVG	258	1.0	RB 1 MHz;VB 10 Hz;Pk, note 2
3215.970	49.4	H	74.0	-24.6	PK	258	1.0	RB 1 MHz;VB 3 MHz;Pk, note 2
4822.660	39.5	V	54.0	-14.5	AVG	64	1.2	RB 1 MHz;VB 10 Hz;Pk
4821.960	51.8	V	74.0	-22.2	PK	64	1.2	RB 1 MHz;VB 3 MHz;Pk

Note 1: For emissions in restricted bands, the limit of 15.209 was used. For all other emissions, the limit is -30dBc for peak measurements in a measurement bandwidth of 100kHz.

Note 2: Restricted band limit used for non-restricted band emission.

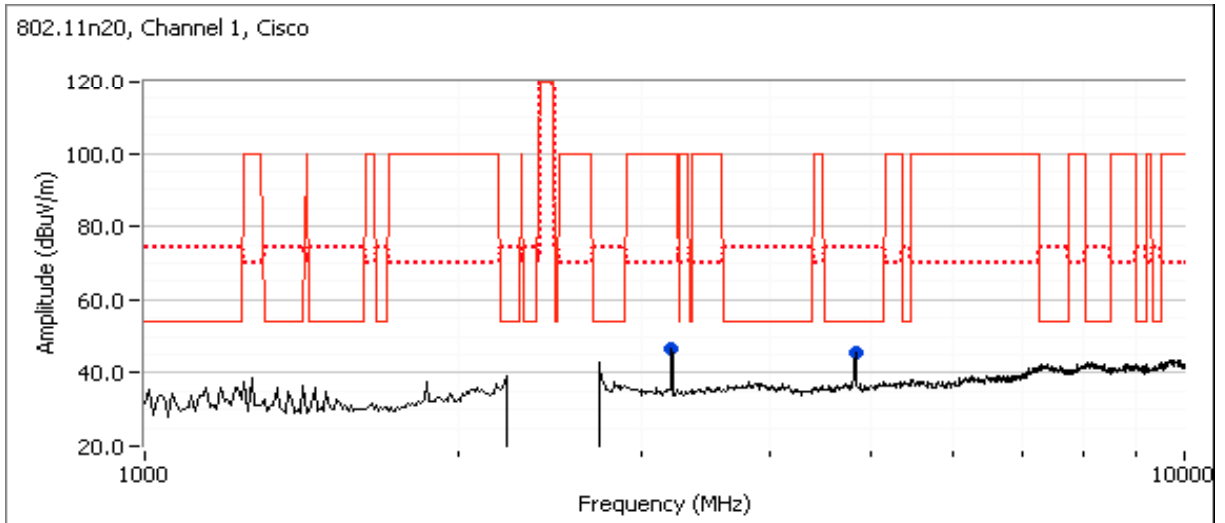

Client:	Summit Data Communications	Job Number:	J78403
Model:	SDC-MSD40NBT (1x1 802.11abg + BT 2.1)	T-Log Number:	T83195
Contact:	Ron Seide	Account Manager:	Christine Krebill
Standard:	FCC 15.247/RSS-210	Class:	N/A

Run # 3c: , EUT on Channel #11 2462MHz - 802.11n20 MCS0, Chain A

Spurious Radiated Emissions:

Frequency	Level	Pol	15.209/15.247		Detector	Azimuth	Height	Comments
MHz	dB μ V/m	v/h	Limit	Margin	Pk/QP/Avg	degrees	meters	
3282.650	46.2	H	54.0	-7.8	AVG	248	1.2	RB 1 MHz;VB 10 Hz;Pk, note 2
3282.850	49.5	H	74.0	-24.5	PK	248	1.2	RB 1 MHz;VB 3 MHz;Pk, note 2
4923.650	36.2	V	54.0	-17.8	AVG	24	1.0	RB 1 MHz;VB 10 Hz;Pk
4927.630	49.8	V	74.0	-24.2	PK	24	1.0	RB 1 MHz;VB 3 MHz;Pk

Note 1: For emissions in restricted bands, the limit of 15.209 was used. For all other emissions, the limit is -30dBc for peak measurements in a measurement bandwidth of 100kHz.

Note 2: Restricted band limit used for non-restricted band emission.

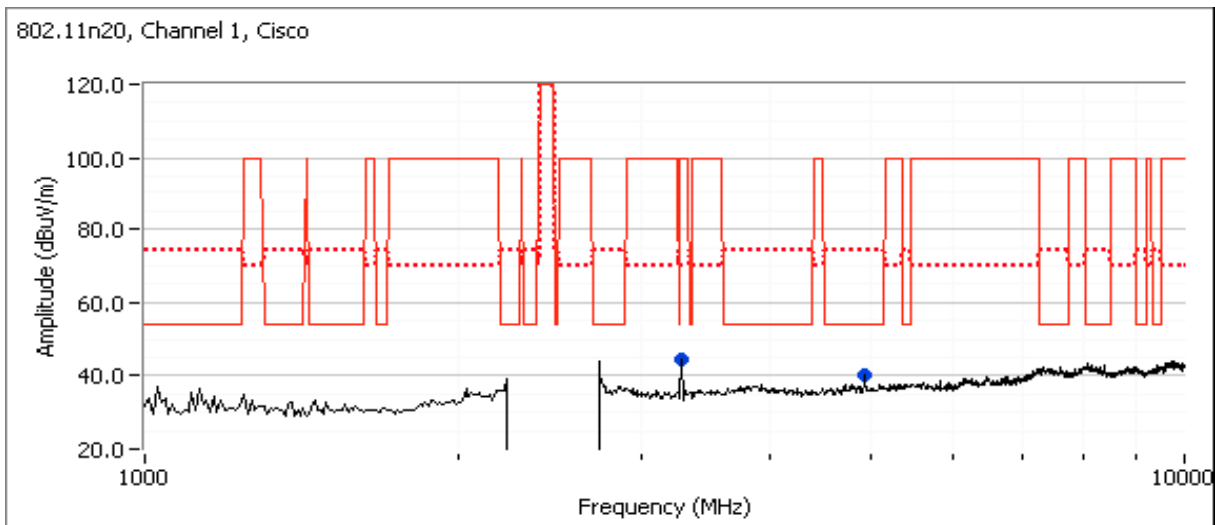

Client:	Summit Data Communications	Job Number:	J78403
Model:	SDC-MSD40NBT (1x1 802.11abg + BT 2.1)	T-Log Number:	T83195
		Account Manager:	Christine Krebill
Contact:	Ron Seide		
Standard:	FCC 15.247/RSS-210	Class:	N/A

Run # 4, Radiated Spurious Emissions, 1-7.5GHz, Receive, Chain A

Date of Test: 5/20/2011
 Test Engineer: John Caizzi

Test Location: FT7
 Config Change: none

Run # 4a, EUT on Channel #6 2437MHz - Receive, Chain A

Frequency MHz	Level dB μ V/m	Pol v/h	RSS 210		Detector Pk/QP/Avg	Azimuth degrees	Height meters	Comments
			Limit	Margin				
3249.350	46.5	H	54.0	-7.5	AVG	269	1.00	
3249.300	49.5	H	74.0	-24.5	PK	269	1.00	
1033.500	45.1	H	54.0	-8.9	AVG	223	1.42	
1033.570	45.4	H	74.0	-28.6	PK	223	1.42	

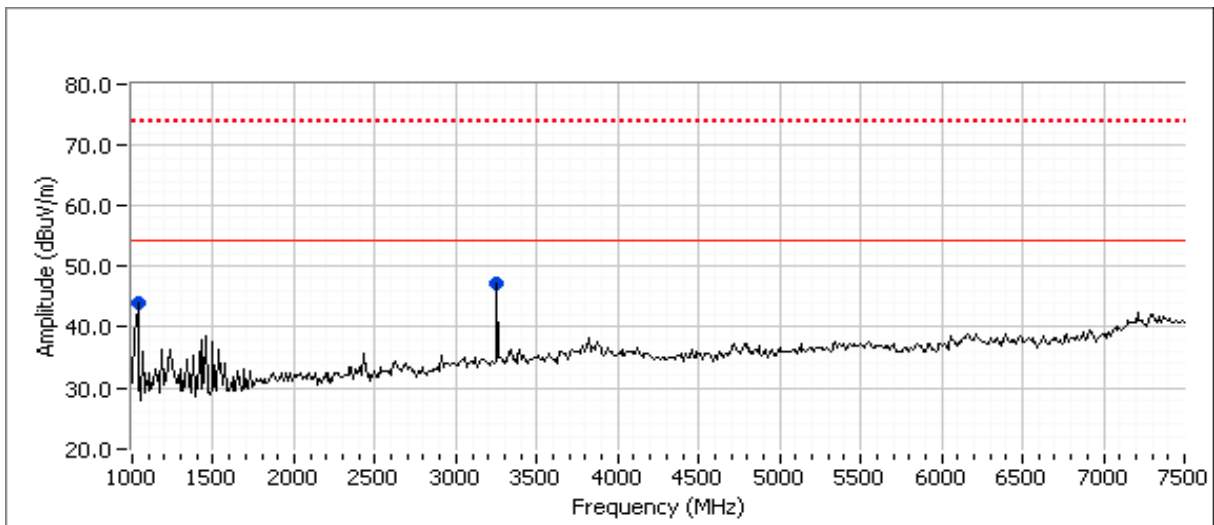

Client:	Summit Data Communications	Job Number:	J78403
Model:	SDC-MSD40NBT (1x1 802.11abg + BT 2.1)	T-Log Number:	T83195
Contact:	Ron Seide	Account Manager:	Christine Krebill
Standard:	FCC 15.247/RSS-210	Class:	N/A

RSS 210 and FCC 15.247 (DTS) Radiated Spurious Emissions

Summary of Results - Device Operating in the 5725 - 5850 MHz Band

SCU: v3.03.01

Run #	Mode	Channel	Antenna	Measured Power	Test Performed	Limit	Result / Margin
Scans on center channel in all three OFDM modes to determine the worst case							
Run # 1	802.11a Chain A	#157 5785MHz	Larsen	-	Radiated Emissions, 1 - 40 GHz	FCC 15.209 / 15.247	46.8dB μ V/m @ 11571.8MHz (-7.2dB)
	802.11n20 Chain A	#157 5785MHz	Larsen	-			47.8dB μ V/m @ 11569.4MHz (-6.2dB)
Top and bottom channels in worst case OFDM mode:							
Run # 2	802.11n20 Chain A	#149 5745MHz	Larsen	-	Radiated Emissions, 1 - 40 GHz	FCC 15.209 / 15.247	46.9dB μ V/m @ 11489.8MHz (-7.1dB)
		#161 5805MHz	Larsen	-			45.6dB μ V/m @ 11608.9MHz (-8.4dB)
Receiver Spurious Emissions							
Run # 3	Receive Chain A	#157, Chain A	Larsen	-	Radiated Emissions, 1 - 18 GHz	RSS 210	40.9dB μ V/m @ 1345.5MHz (-13.1dB)

Test Specific Details

Objective: The objective of this test session is to perform final qualification testing of the EUT with respect to the specification listed above.

General Test Configuration

The EUT and all local support equipment were located on the turntable for radiated spurious emissions testing. For radiated emissions testing the measurement antenna was located 3 meters from the EUT.

Ambient Conditions:

Temperature: 20-25 °C
Rel. Humidity: 40-50 %

Modifications Made During Testing

No modifications were made to the EUT during testing

Deviations From The Standard

No deviations were made from the requirements of the standard.

Client:	Summit Data Communications	Job Number:	J78403
Model:	SDC-MSD40NBT (1x1 802.11abg + BT 2.1)	T-Log Number:	T83195
Contact:	Ron Seide	Account Manager:	Christine Krebill
Standard:	FCC 15.247/RSS-210	Class:	N/A

Run # 1, Radiated Spurious Emissions, 1-40GHz, 802.11a, Chain A

Date of Test: 12/23/2011

Test Location: FT Chamber #4

Test Engineer: Rafael Varelas

Config Change: None

Run # 1a, EUT on Channel #157 5785MHz - 802.11a, Chain A

	Target (dBm)	Power Settings Measured (dBm)	Software Setting
Chain A	100%		100%

Spurious Radiated Emissions:

Frequency	Level	Pol	15.209/15.247		Detector	Azimuth	Height	Comments
MHz	dB μ V/m	v/h	Limit	Margin	Pk/QP/Avg	degrees	meters	
11571.830	46.8	V	54.0	-7.2	AVG	5	1.8	RB 1 MHz;VB 10 Hz;Pk
11575.900	57.9	V	74.0	-16.1	PK	5	1.8	RB 1 MHz;VB 3 MHz;Pk
11568.470	44.4	H	54.0	-9.6	AVG	111	1.1	RB 1 MHz;VB 10 Hz;Pk
11569.970	56.0	H	74.0	-18.0	PK	111	1.1	RB 1 MHz;VB 3 MHz;Pk
1345.470	44.3	H	54.0	-9.7	AVG	212	1.0	RB 1 MHz;VB 10 Hz;Pk
1345.350	46.1	H	74.0	-27.9	PK	212	1.0	RB 1 MHz;VB 3 MHz;Pk
3856.680	40.4	H	54.0	-13.6	AVG	73	1.1	RB 1 MHz;VB 10 Hz;Pk
3856.620	45.7	H	74.0	-28.3	PK	73	1.1	RB 1 MHz;VB 3 MHz;Pk

Note 1: For emissions in restricted bands, the limit of 15.209 was used. For all other emissions, the limit is -30dBc for peak measurements in a measurement bandwidth of 100kHz.

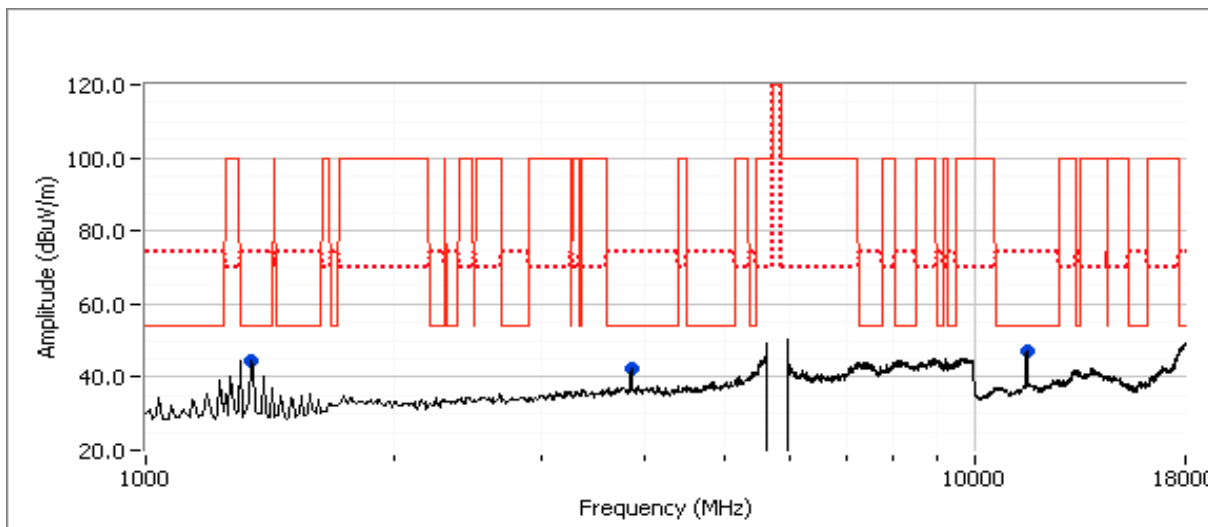

Client:	Summit Data Communications	Job Number:	J78403
Model:	SDC-MSD40NBT (1x1 802.11abg + BT 2.1)	T-Log Number:	T83195
Contact:	Ron Seide	Account Manager:	Christine Krebill
Standard:	FCC 15.247/RSS-210	Class:	N/A

Run # 1b: , EUT on Channel #157 5785MHz - 802.11n20, Chain A

	Target (dBm)	Power Settings Measured (dBm)	Software Setting
Chain A	100%		100%

Spurious Radiated Emissions:

Frequency MHz	Level dBμV/m	Pol v/h	15.209/15.247		Detector Pk/QP/Avg	Azimuth degrees	Height meters	Comments
			Limit	Margin				
11569.400	47.8	V	54.0	-6.2	AVG	341	1.7	RB 1 MHz;VB 10 Hz;Pk
11568.560	60.0	V	74.0	-14.0	PK	341	1.7	RB 1 MHz;VB 3 MHz;Pk
11569.960	45.2	H	54.0	-8.8	AVG	101	1.1	RB 1 MHz;VB 10 Hz;Pk
11568.530	57.4	H	74.0	-16.6	PK	101	1.1	RB 1 MHz;VB 3 MHz;Pk
3856.680	42.9	H	54.0	-11.1	AVG	330	1.2	RB 1 MHz;VB 10 Hz;Pk
3856.710	47.5	H	74.0	-26.5	PK	330	1.2	RB 1 MHz;VB 3 MHz;Pk
1345.530	40.8	H	54.0	-13.2	AVG	273	1.0	RB 1 MHz;VB 10 Hz;Pk
1345.600	43.9	H	74.0	-30.1	PK	273	1.0	RB 1 MHz;VB 3 MHz;Pk

- Note 1: For emissions in restricted bands, the limit of 15.209 was used. For all other emissions, the limit is -30dBc for peak measurements in a measurement bandwidth of 100kHz.
- Note 2: Scans made between 18 - 40GHz with the measurement antenna moved around the card and its antennas 20-50cm from the device indicated there were no significant emissions in this frequency range

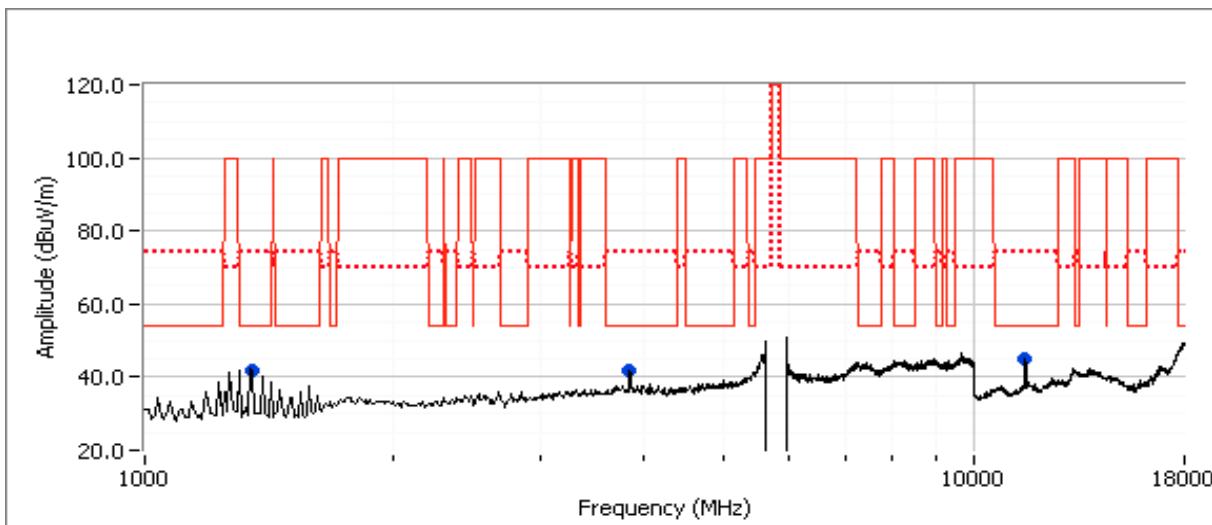

Client:	Summit Data Communications	Job Number:	J78403
Model:	SDC-MSD40NBT (1x1 802.11abg + BT 2.1)	T-Log Number:	T83195
Contact:	Ron Seide	Account Manager:	Christine Krebill
Standard:	FCC 15.247/RSS-210	Class:	N/A

Run # 2, Radiated Spurious Emissions, 1-40GHz, 802.11n20, Chain A
 Date of Test: 12/23/2011 Test Location: FT Chamber #4
 Test Engineer: Rafael Varelas Config Change: None

Run # 2a, EUT on Channel #149 5745MHz - 802.11n20, Chain A

Chain	Target (dBm)	Power Settings Measured (dBm)	Software Setting
	Chain A	100%	

Spurious Radiated Emissions:

Frequency MHz	Level dBμV/m	Pol v/h	15.209/15.247		Detector Pk/QP/Avg	Azimuth degrees	Height meters	Comments
			Limit	Margin				
11489.770	46.9	V	54.0	-7.1	AVG	95	1.5	RB 1 MHz;VB 10 Hz;Pk
11490.400	59.1	V	74.0	-14.9	PK	95	1.5	RB 1 MHz;VB 3 MHz;Pk
11489.870	45.1	H	54.0	-8.9	AVG	102	1.0	RB 1 MHz;VB 10 Hz;Pk
11487.330	56.5	H	74.0	-17.5	PK	102	1.0	RB 1 MHz;VB 3 MHz;Pk
3830.000	41.6	H	54.0	-12.4	AVG	329	1.0	RB 1 MHz;VB 10 Hz;Pk
3830.000	46.2	H	74.0	-27.8	PK	329	1.0	RB 1 MHz;VB 3 MHz;Pk
1306.370	41.4	V	54.0	-12.6	AVG	169	1.2	RB 1 MHz;VB 10 Hz;Pk
1306.430	44.8	V	74.0	-29.2	PK	169	1.2	RB 1 MHz;VB 3 MHz;Pk

Note 1: For emissions in restricted bands, the limit of 15.209 was used. For all other emissions, the limit is -30dBc for peak measurements in a measurement bandwidth of 100kHz.

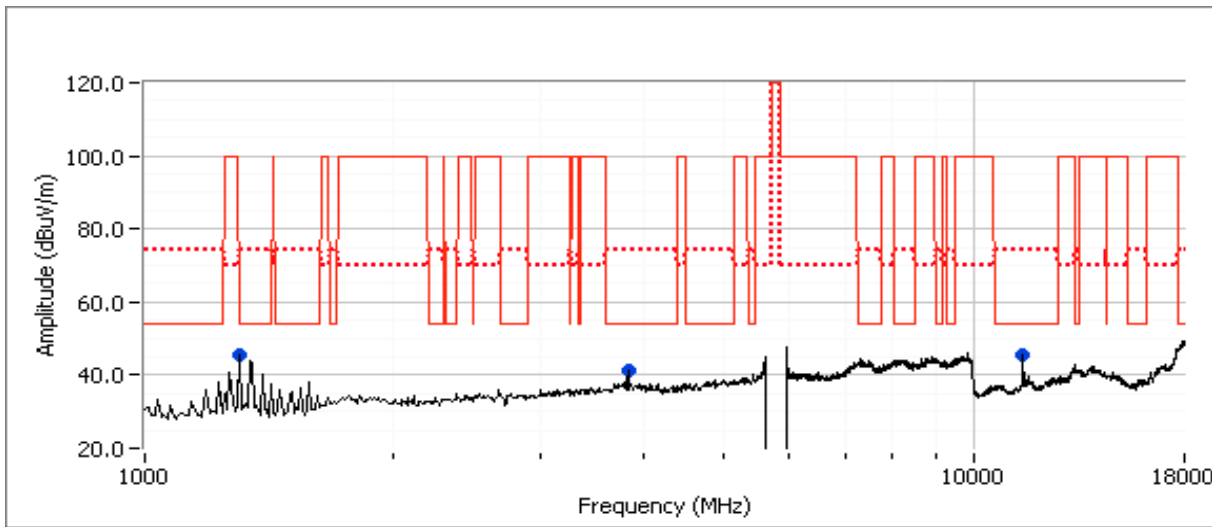

Client:	Summit Data Communications	Job Number:	J78403
Model:	SDC-MSD40NBT (1x1 802.11abg + BT 2.1)	T-Log Number:	T83195
Contact:	Ron Seide	Account Manager:	Christine Krebill
Standard:	FCC 15.247/RSS-210	Class:	N/A

Run # 2c : EUT on Channel #161 5805MHz - 802.11n20, Chain A

	Target (dBm)	Power Settings Measured (dBm)	Software Setting
Chain A	100%		100%

Spurious Radiated Emissions:

Frequency MHz	Level dB μ V/m	Pol v/h	15.209/15.247		Detector Pk/QP/Avg	Azimuth degrees	Height meters	Comments
			Limit	Margin				
11608.940	45.6	H	54.0	-8.4	AVG	88	1.0	RB 1 MHz;VB 10 Hz;Pk
11612.840	57.5	H	74.0	-16.5	PK	88	1.0	RB 1 MHz;VB 3 MHz;Pk
11608.910	45.4	V	54.0	-8.6	AVG	89	1.0	RB 1 MHz;VB 10 Hz;Pk
11607.080	56.7	V	74.0	-17.3	PK	89	1.0	RB 1 MHz;VB 3 MHz;Pk
1306.550	44.9	V	54.0	-9.1	AVG	206	1.0	RB 1 MHz;VB 10 Hz;Pk
1306.430	46.9	V	74.0	-27.1	PK	206	1.0	RB 1 MHz;VB 3 MHz;Pk
3870.040	42.4	H	54.0	-11.6	AVG	322	1.4	RB 1 MHz;VB 10 Hz;Pk
3869.890	47.5	H	74.0	-26.5	PK	322	1.4	RB 1 MHz;VB 3 MHz;Pk

Note 1: For emissions in restricted bands, the limit of 15.209 was used. For all other emissions, the limit is -30dBc for peak measurements in a measurement bandwidth of 100kHz.

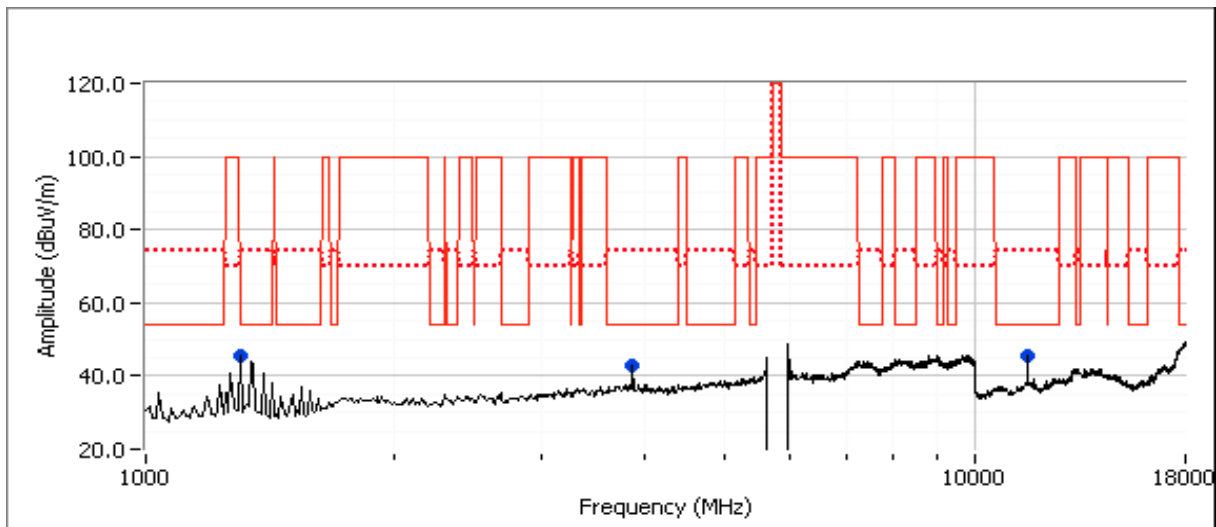

Client:	Summit Data Communications	Job Number:	J78403
Model:	SDC-MSD40NBT (1x1 802.11abg + BT 2.1)	T-Log Number:	T83195
Contact:	Ron Seide	Account Manager:	Christine Krebill
Standard:	FCC 15.247/RSS-210	Class:	N/A

Run # 3, Radiated Spurious Emissions, 1-18GHz, Receive, Chain A

Date of Test: 12/23/2011

Test Location: FT Chamber #4

Test Engineer: Rafael Varelas

Config Change: None

Run # 3a, EUT on Channel #157, 5785MHz - Receive, Chain A

Frequency MHz	Level dB μ V/m	Pol v/h	RSS 210		Detector PK/QP/Avg	Azimuth degrees	Height meters	Comments
			Limit	Margin				
1345.500	40.9	V	54.0	-13.1	AVG	329	1.1	RB 1 MHz;VB 10 Hz;Pk
1345.500	43.8	V	74.0	-30.2	PK	329	1.1	RB 1 MHz;VB 3 MHz;Pk

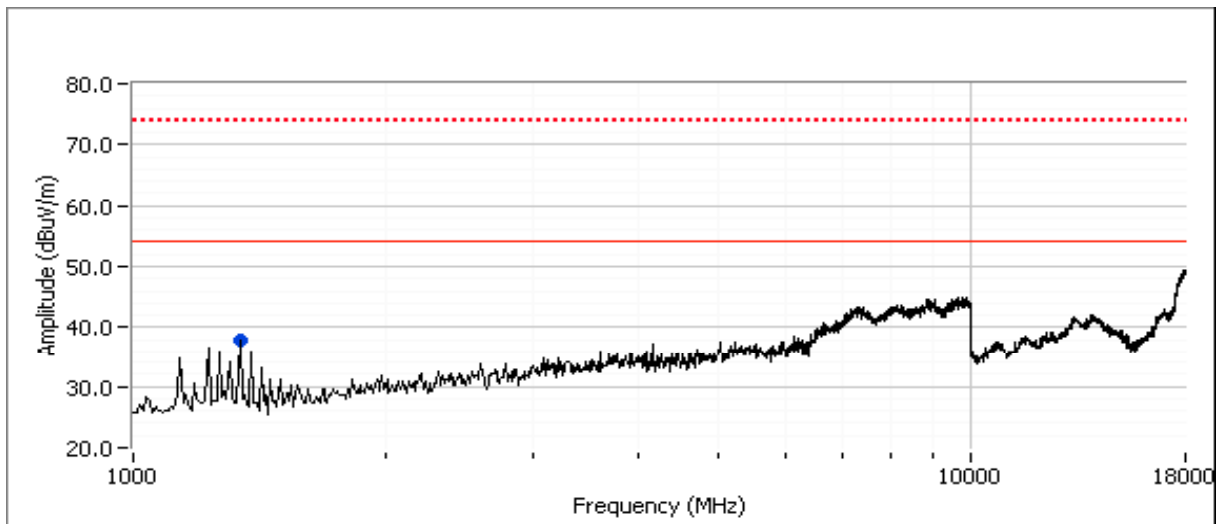

Client:	Summit Data Communications	Job Number:	J78403
Model:	SDC-MSD40NBT (1x1 802.11abg + BT 2.1)	T-Log Number:	T83195
		Account Manager:	Christine Krebill
Contact:	Ron Seide		
Standard:	FCC 15.247/RSS-210	Class:	N/A

**RSS 210 and FCC 15.247 (DTS) Antenna Port Measurements
Power, PSD, Bandwidth and Spurious Emissions**

Test Specific Details

Objective: The objective of this test session is to perform final qualification testing of the EUT with respect to the specification listed above.

Date of Test: 2/6/2012
 Test Engineer: Joseph Cadigal
 Test Location: FT Lab #4

Config. Used: 2
 Config Change: no antennas
 EUT Voltage: 3.3 VDC

General Test Configuration

The EUT was connected to the spectrum analyzer or power meter via a suitable attenuator. All measurements were made on a single chain.

All measurements have been corrected to allow for the external attenuators used.

Ambient Conditions:

Temperature: 23 °C
 Rel. Humidity: 37 %

Summary of Results

Run #	Pwr setting	Avg Pwr	Test Performed	Limit	Pass / Fail	Result / Margin
1	-	-	Output Power	15.247(b)	Pass	See Below

Modifications Made During Testing

No modifications were made to the EUT during testing

Deviations From The Standard

No deviations were made from the requirements of the standard.

Client:	Summit Data Communications	Job Number:	J78403
Model:	SDC-MSD40NBT (1x1 802.11abg + BT 2.1)	T-Log Number:	T83195
		Account Manager:	Christine Krebill
Contact:	Ron Seide		
Standard:	FCC 15.247/RSS-210	Class:	N/A

Run #1: Output Power
SCU V3.03.14

Power Setting ²	Frequency (MHz)	Output Power		Antenna Gain (dBi)	Result	EIRP ^{Note 2}		Output Power	
		(dBm) ¹	mW			dBm	W	(dBm) ³	mW
802.11b mode									
-	2412	15.7	37.2	2.0	Pass	17.7	0.059	17.6	57.5
-	2437	15.9	39.1	2.0	Pass	17.9	0.062	17.5	56.2
-	2462	10.1	10.2	2.0	Pass	12.1	0.016	12.9	19.5
802.11g mode									
-	2412	14.7	29.7	2.0	Pass	16.7	0.047	20.5	112.2
-	2437	14.1	25.7	2.0	Pass	16.1	0.041	20.4	109.6
-	2462	10.7	11.6	2.0	Pass	12.7	0.018	19.4	87.1
802.11n20 mode									
-	2412	14.2	26.3	2.0	Pass	16.2	0.042	20.0	100.0
-	2437	11.6	14.3	2.0	Pass	13.6	0.023	18.5	70.8
-	2462	10.0	10.1	2.0	Pass	12.0	0.016	18.9	77.6

Note 1:	Output power measured using a spectrum analyzer (see plots below) with RBW=1MHz, VB=3 MHz, sample detector, power averaging on (transmitted signal was not continuous but the ESI analyzer was configured with a gated sweep such that the analyzer was only sweeping when the device was transmitting) and power integration over 50 MHz (option #2, method 1 in KDB 558074, equivalent to method 1 of DA-02-2138A1 for U-NII devices). Spurious limit becomes -30dBc.
Note 2:	Power setting - the software power setting used during testing, included for reference only.
Note 3:	Power measured using peak power meter and is included for reference only.

Client:	Summit Data Communications	Job Number:	J78403
Model:	SDC-MSD40NBT (1x1 802.11abg + BT 2.1)	T-Log Number:	T83195
Contact:	Ron Seide	Account Manager:	Christine Krebill
Standard:	FCC 15.247/RSS-210	Class:	N/A

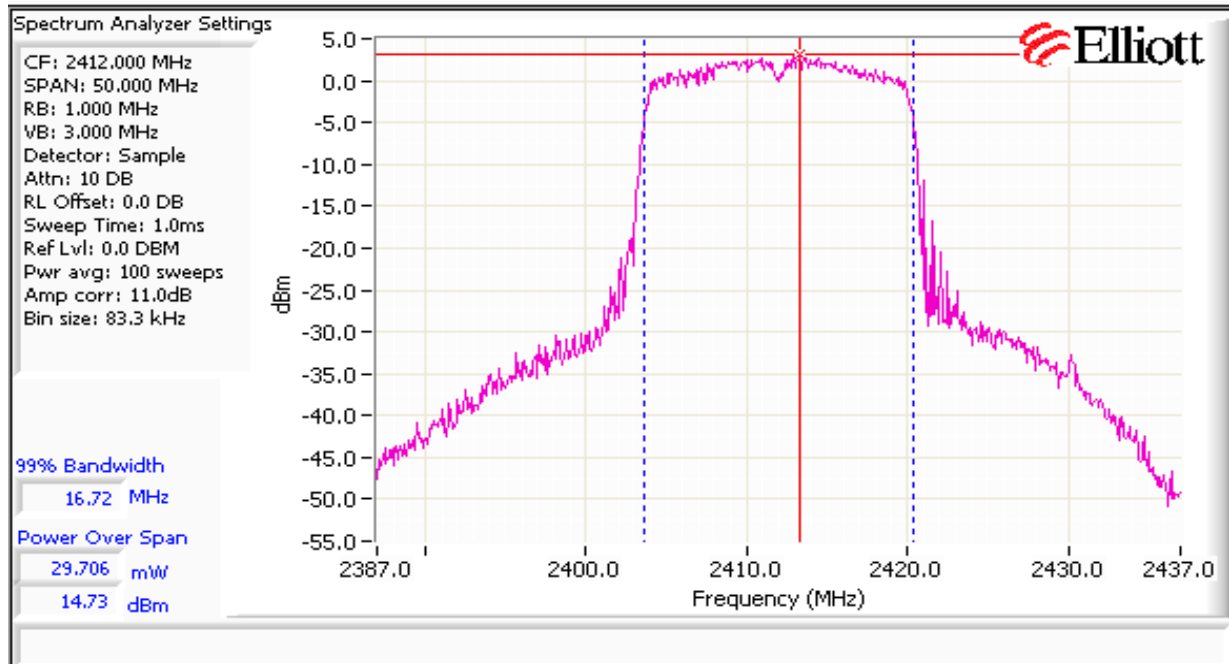
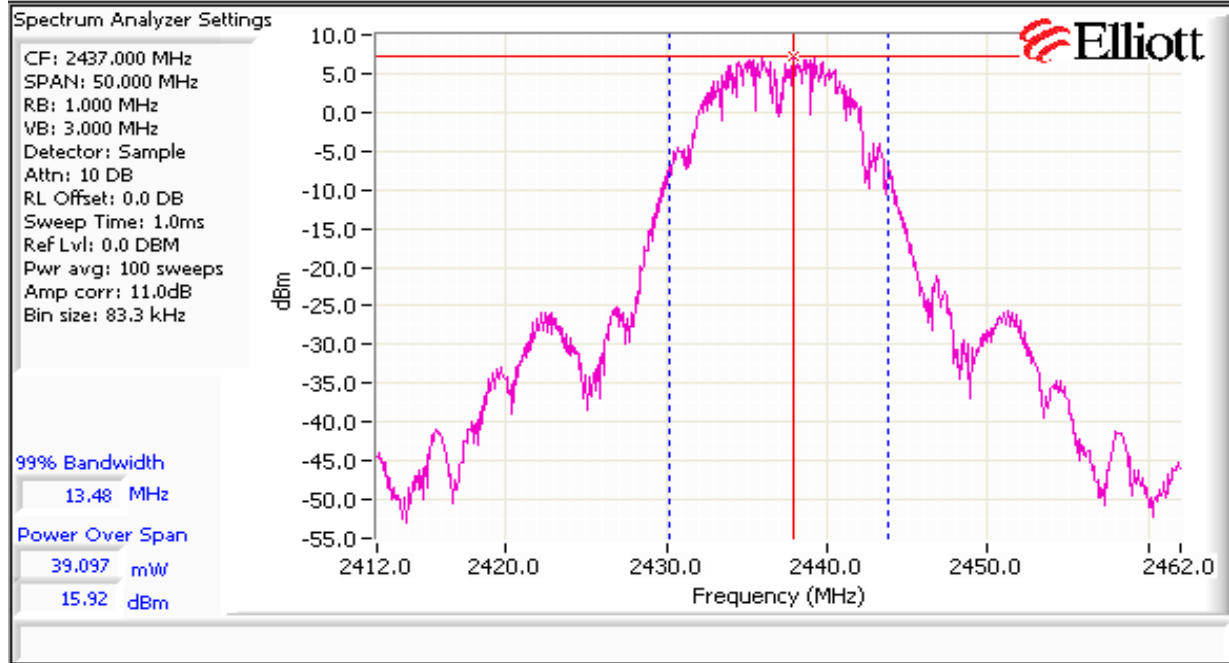

Client:	Summit Data Communications	Job Number:	J78403
Model:	SDC-MSD40NBT (1x1 802.11abg + BT 2.1)	T-Log Number:	T83195
Contact:	Ron Seide	Account Manager:	Christine Krebill
Standard:	FCC 15.247/RSS-210	Class:	N/A

Power Setting ²	Frequency (MHz)	Output Power (dBm) ¹		Antenna Gain (dBi)	Result	EIRP ^{Note 2}		Output Power (dBm) ³	
		dBm	mW			dBm	W	dBm	mW
802.11a mode									
-	5745	15.7	37.2	5.0	Pass	20.7	0.117	19.1	81.3
-	5785	15.5	35.5	5.0	Pass	20.5	0.112	18.7	74.1
-	5805	15.8	38.0	5.0	Pass	20.8	0.120	18.6	72.4
802.11n20 mode									
-	5745	15.7	37.2	5.0	Pass	20.7	0.117	19.1	81.3
-	5785	15.4	34.7	5.0	Pass	20.4	0.110	18.6	72.4
-	5805	15.3	33.9	5.0	Pass	20.3	0.107	18.4	69.2

- Note 1: Output power measured using a spectrum analyzer (see plots below) with RBW=1MHz, VB=3 MHz, sample detector, power averaging on (transmitted signal was not continuous but the ESI analyzer was configured with a gated sweep such that the analyzer was only sweeping when the device was transmitting) and power integration over 50 MHz (option #2, method 1 in KDB 558074, equivalent to method 1 of DA-02-2138A1 for U-NII devices). Spurious limit becomes -30dBc.
- Note 2: Power setting - the software power setting used during testing, included for reference only.
- Note 3: Power measured using peak power meter and is included for reference only.

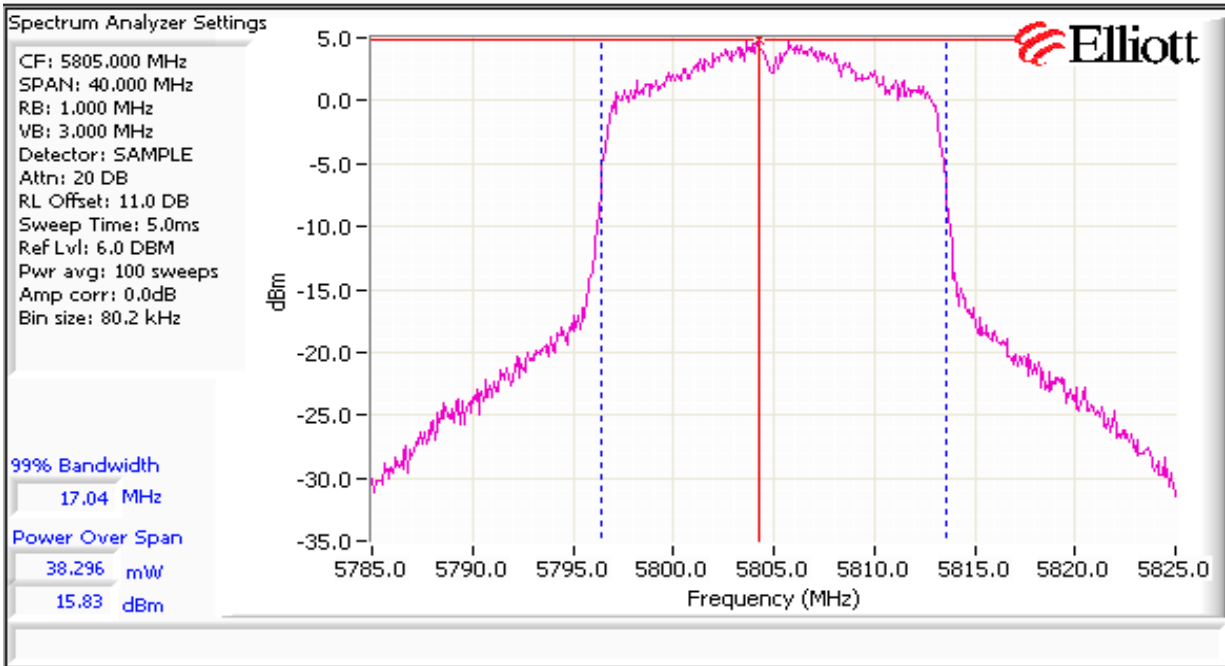

Client:	Summit Data Communications	Job Number:	J78403
Model:	SDC-MSD40NBT (1x1 802.11abg + BT 2.1)	T-Log Number:	T83195
		Account Manager:	Christine Krebill
Contact:	Ron Seide		
Standard:	FCC 15.247/RSS-210	Class:	N/A

**RSS 210 and FCC 15.247 (DTS) Antenna Port Measurements (802.11b)
Power, PSD, Bandwidth and Spurious Emissions**

Test Specific Details

Objective: The objective of this test session is to perform final qualification testing of the EUT with respect to the specification listed above.

Date of Test: 8/23/2011	Config. Used: 2
Test Engineer: John Caizzi / Rafael Varelas	Config Change: no antennas
Test Location: FT Lab #4	EUT Voltage: 3.3 VDC

General Test Configuration

The EUT was connected to the spectrum analyzer or power meter via a suitable attenuator. All measurements were made on a single chain.

All measurements have been corrected to allow for the external attenuators used.

Ambient Conditions:

Temperature: 23 °C
Rel. Humidity: 37 %

Summary of Results

Run #	Pwr setting	Avg Pwr	Test Performed	Limit	Pass / Fail	Result / Margin
2	-	-	Power spectral Density (PSD)	15.247(d)	Pass	-5.3 dBm/3kHz
3	-	-	Minimum 6dB Bandwidth	15.247(a)	Pass	9.0 MHz
3	-	-	99% Bandwidth	RSS GEN	-	12.8 MHz
4	-	-	Spurious emissions	15.247(b)	Pass	All emissions < -30 dBc

Modifications Made During Testing

No modifications were made to the EUT during testing

Deviations From The Standard

No deviations were made from the requirements of the standard.

Client: Summit Data Communications	Job Number: J78403
Model: SDC-MSD40NBT (1x1 802.11abg + BT 2.1)	T-Log Number: T83195
	Account Manager: Christine Krebill
Contact: Ron Seide	
Standard: FCC 15.247/RSS-210	Class: N/A

Run #2: Power spectral Density

Power Setting	Frequency (MHz)	PSD	Limit dBm/3kHz	Result
		(dBm/3kHz) ^{Note 1}		
-	2412.697	-7.5	8.0	Pass
-	2437.7377	-5.3	8.0	Pass
-	2461.1764	-6.2	8.0	Pass

Note 1: Power spectral density measured using RB=3 kHz, VB=10kHz, analyzer with peak detector and with a sweep time set to ensure a dwell time of at least 1 second per 3kHz. The measurement is made at the frequency of PPSD determined from preliminary scans using RB=3kHz using multiple sweeps at a faster rate over the 6dB bandwidth of the signal.

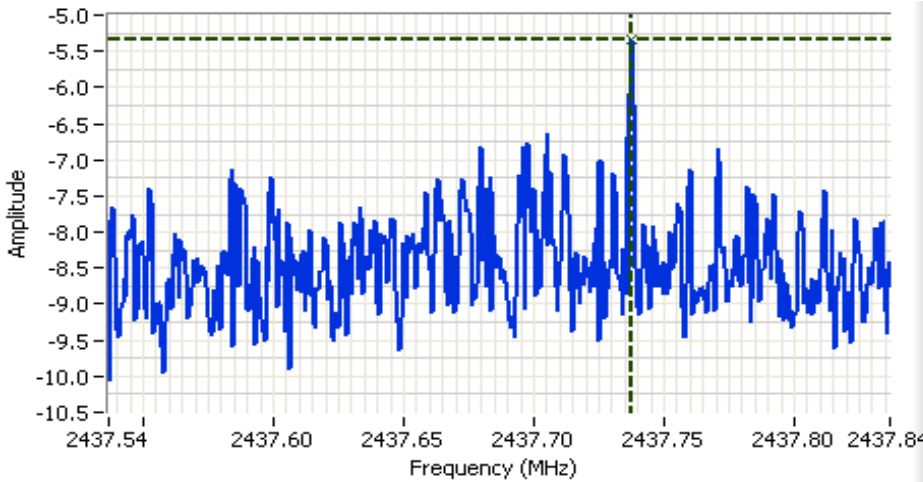

Analyzer Settings
 Agilent Technologies, E4446A
 CF: 2437.687 MHz
 SPAN: 300 kHz
 RB: 3.00 kHz
 VB: 10.0 kHz
 Detector: POS
 Attn: 20 DB
 RL Offset: 10.5 DB
 Sweep Time: 100.0s
 Ref Lvl: 1.5 DBM

Comments
 PSD = -5.3 dBm/3kHz
 802.11b

Cursor 1 2437.7377 -5.34 [Icons]
 0.0000 0.00 [Icons]



Client:	Summit Data Communications	Job Number:	J78403
Model:	SDC-MSD40NBT (1x1 802.11abg + BT 2.1)	T-Log Number:	T83195
Contact:	Ron Seide	Account Manager:	Christine Krebill
Standard:	FCC 15.247/RSS-210	Class:	N/A

Run #3: Signal Bandwidth

Power Setting	Frequency (MHz)	Resolution Bandwidth	Bandwidth (MHz)	
			6dB	99%
-	2412	100kHz	9.0	12.8
-	2437	100kHz	9.1	12.5
-	2462	100kHz	9.1	12.7

Note 1: 99% bandwidth measured in accordance with RSS GEN, with RB > 1% of the span and VB > 3xRB



Analyzer Settings
 Agilent Technologies, E4446A
 CF: 2412.000 MHz
 SPAN: 50.000 MHz
 RB: 100 kHz
 VB: 100 kHz
 Detector: POS
 Attn: 20 DB
 RL Offset: 0.0 DB
 Sweep Time: 6.0ms
 Ref Lvl: 10.0 DBM

Comments
 6dB BW: 9.000 MHz

Cursor 1	2416.5000	-5.34	Delta Freq.	9.000
Cursor 2	2407.5000	-11.34	Delta Amplitude	6.00



Run #4: Out of Band Spurious Emissions

Frequency (MHz)	Limit	Result
2412	-30dBc	Pass
2437	-30dBc	Pass
2462	-30dBc	Pass

Client:	Summit Data Communications	Job Number:	J78403
Model:	SDC-MSD40NBT (1x1 802.11abg + BT 2.1)	T-Log Number:	T83195
Contact:	Ron Seide	Account Manager:	Christine Krebill
Standard:	FCC 15.247/RSS-210	Class:	N/A

Plots for low channel, power setting = default

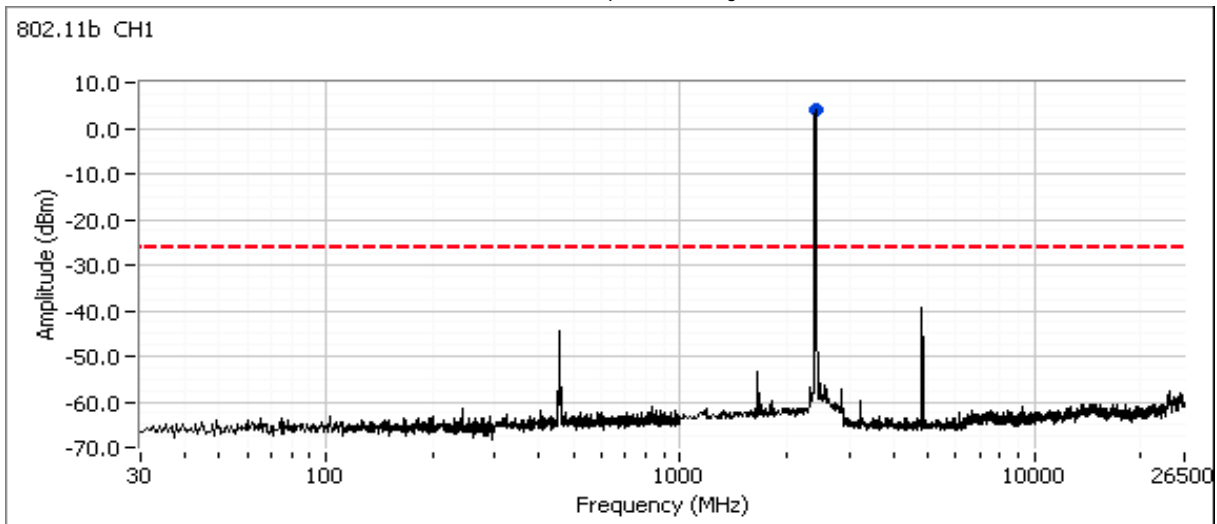

Additional plot showing compliance with -30dBc limit from 2390 MHz to 2400 MHz. Radiated measurements used to show compliance with the limits in the restricted band below 2390 MHz.



Client:	Summit Data Communications	Job Number:	J78403
Model:	SDC-MSD40NBT (1x1 802.11abg + BT 2.1)	T-Log Number:	T83195
Contact:	Ron Seide	Account Manager:	Christine Krebill
Standard:	FCC 15.247/RSS-210	Class:	N/A

Plots for center channel, power setting = default

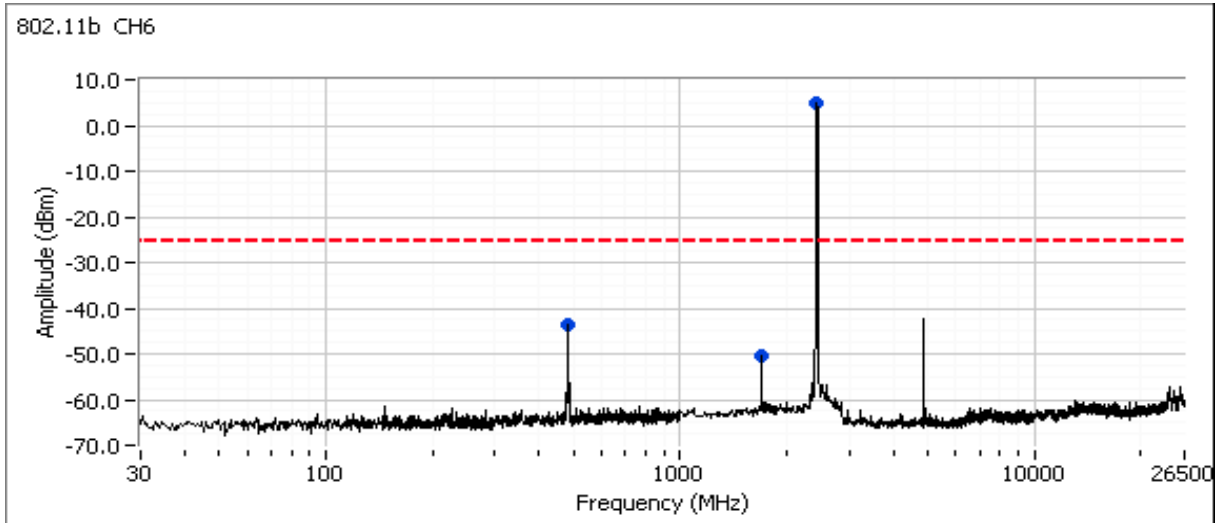

Plots for high channel, power setting = default

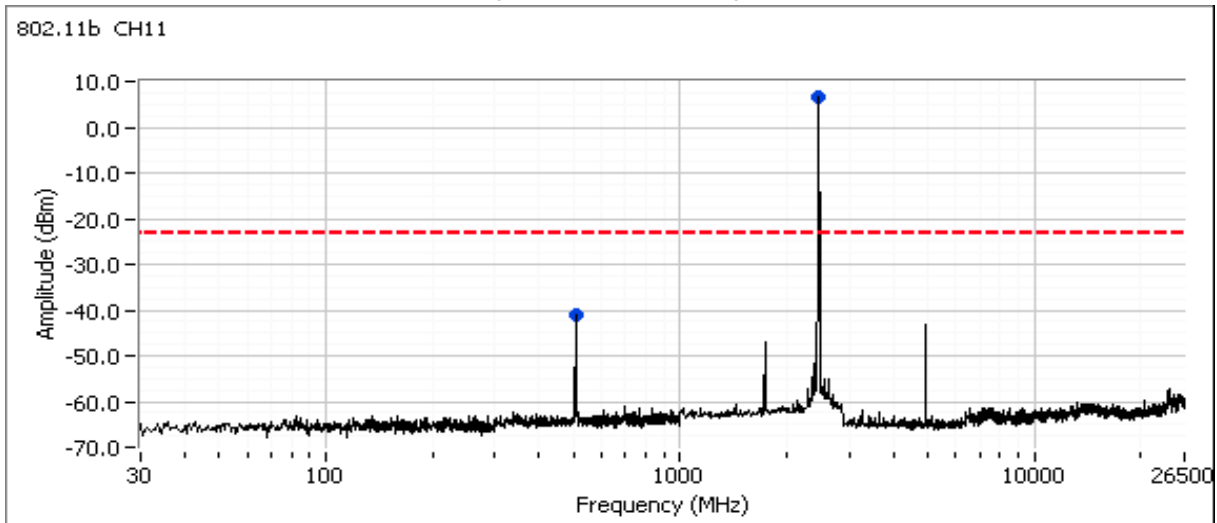

Client:	Summit Data Communications	Job Number:	J78403
Model:	SDC-MSD40NBT (1x1 802.11abg + BT 2.1)	T-Log Number:	T83195
		Account Manager:	Christine Krebill
Contact:	Ron Seide		
Standard:	FCC 15.247/RSS-210	Class:	N/A

**RSS 210 and FCC 15.247 (DTS) Antenna Port Measurements (802.11g)
Power, PSD, Bandwidth and Spurious Emissions**

Test Specific Details

Objective: The objective of this test session is to perform final qualification testing of the EUT with respect to the specification listed above.

Date of Test: 2/6/2012
Test Engineer: Joseph Cadigal
Test Location: FT Lab #4

Config. Used: 2
Config Change: no antennas
EUT Voltage: 3.3 VDC

General Test Configuration

The EUT was connected to the spectrum analyzer or power meter via a suitable attenuator. All measurements were made on a single chain.

All measurements have been corrected to allow for the external attenuators used.

Ambient Conditions:

Temperature: 23 °C
Rel. Humidity: 37 %

Summary of Results

Run #	Pwr setting	Avg Pwr	Test Performed	Limit	Pass / Fail	Result / Margin
2	default	-	Power spectral Density (PSD)	15.247(d)	Pass	-12.3 dBm/3kHz
3	default	-	Minimum 6dB Bandwidth	15.247(a)	Pass	15.1 MHz
3	default	-	99% Bandwidth	RSS GEN	-	18.5 MHz
4	default	-	Spurious emissions	15.247(b)	Pass	All emissions < -30 dBc

Modifications Made During Testing

No modifications were made to the EUT during testing

Deviations From The Standard

No deviations were made from the requirements of the standard.

Client: Summit Data Communications	Job Number: J78403
Model: SDC-MSD40NBT (1x1 802.11abg + BT 2.1)	T-Log Number: T83195
	Account Manager: Christine Krebill
Contact: Ron Seide	
Standard: FCC 15.247/RSS-210	Class: N/A

Run #2: Power spectral Density

Power Setting	Frequency (MHz)	PSD	Limit dBm/3kHz	Result
		(dBm/3kHz) ^{Note 1}		
-	2412.697	-14.7	8.0	Pass
-	2436.966	-12.3	8.0	Pass
-	2459.4993	-14.1	8.0	Pass

Note 1: Power spectral density measured using RB=3 kHz, VB=10kHz, analyzer with peak detector and with a sweep time set to ensure a dwell time of at least 1 second per 3kHz. The measurement is made at the frequency of PPSD determined from preliminary scans using RB=3kHz using multiple sweeps at a faster rate over the 6dB bandwidth of the signal.

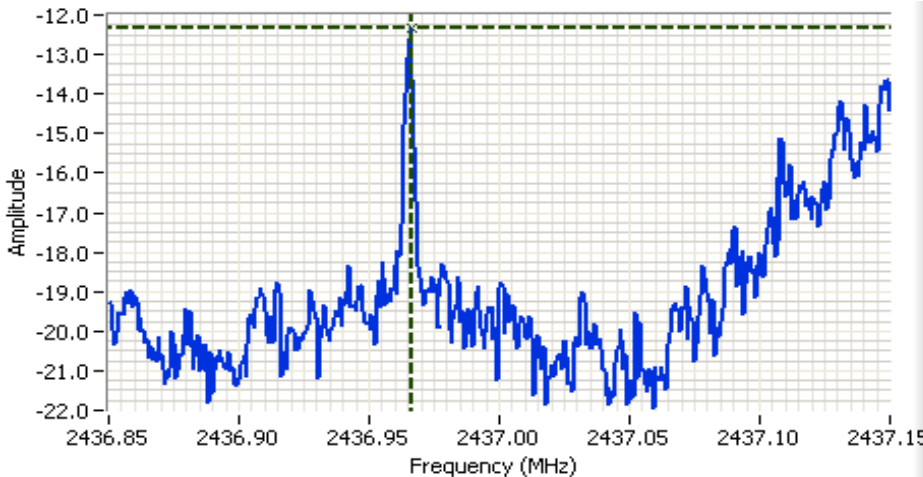

Analyzer Settings
 Rohde&Schwarz,ESI
 CF: 2437.000 MHz
 SPAN: 300 kHz
 RB: 3.00 kHz
 VB: 10.0 kHz
 Detector: POS
 Attn: 20 DB
 RL Offset: 10.5 DB
 Sweep Time: 100.0s
 Ref Lvl: 18.5 DBM

Comments
 PSD = -12.34 dBm/3kHz
 802.11g

Cursor 1 2436.9660 -12.34 [Icons]
 0.0000 0.00 [Icons]



Client: Summit Data Communications	Job Number: J78403
Model: SDC-MSD40NBT (1x1 802.11abg + BT 2.1)	T-Log Number: T83195
	Account Manager: Christine Krebill
Contact: Ron Seide	
Standard: FCC 15.247/RSS-210	Class: N/A

Run #3: Signal Bandwidth

Power Setting	Frequency (MHz)	Resolution Bandwidth	Bandwidth (MHz)	
			6dB	99%
-	2412	100kHz	15.1	18.4
-	2437	100kHz	15.1	18.5
-	2462	100kHz	15.1	16.7

Note 1: 99% bandwidth measured in accordance with RSS GEN, with RB > 1% of the span and VB > 3xRB

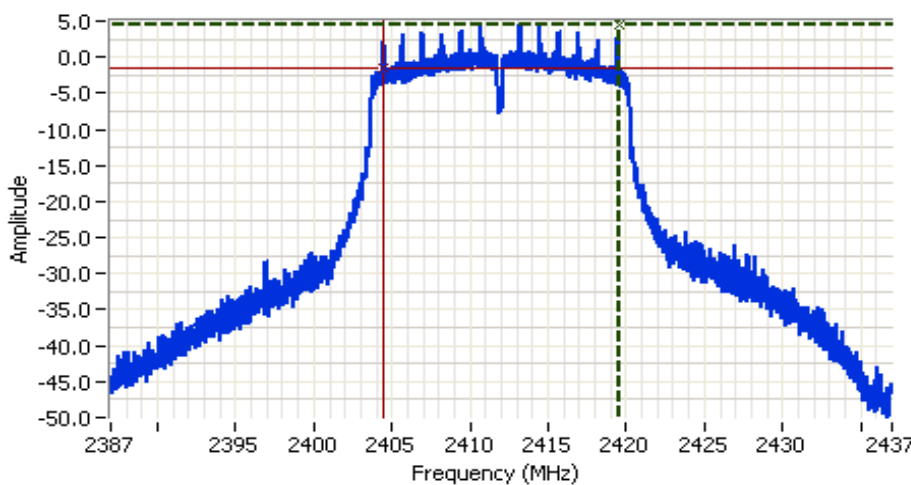

Analyzer Settings
 Agilent Technologies, E4446A
 CF: 2412.000 MHz
 SPAN: 50.000 MHz
 RB: 100 kHz
 VB: 100 kHz
 Detector: POS
 Attn: 20 DB
 RL Offset: 11.0 DB
 Sweep Time: 50.2ms
 Ref Lvl: 18.0 DBM

Comments
 6dB BW: 15.105 MHz

Cursor 1	2419.5275	4.53	Delta Freq.	15.105
Cursor 2	2404.4225	-1.47	Delta Amplitude	6.00



Run #4: Out of Band Spurious Emissions

Frequency (MHz)	Limit	Result
2412	-30dBc	Pass
2437	-30dBc	Pass
2462	-30dBc	Pass

Client:	Summit Data Communications	Job Number:	J78403
Model:	SDC-MSD40NBT (1x1 802.11abg + BT 2.1)	T-Log Number:	T83195
Contact:	Ron Seide	Account Manager:	Christine Krebill
Standard:	FCC 15.247/RSS-210	Class:	N/A

Plots for low channel, power setting = default

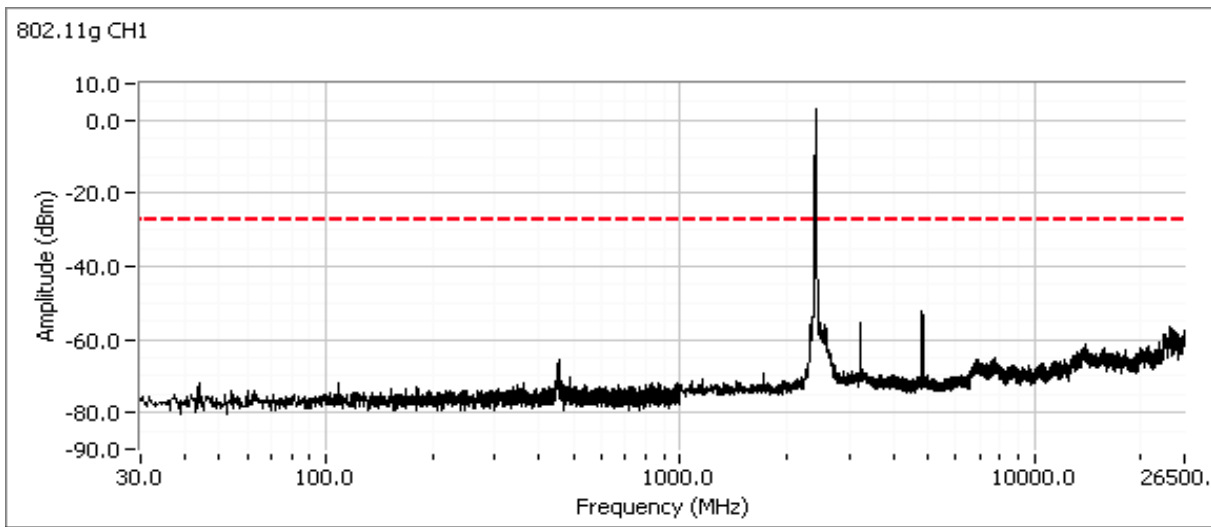

Additional plot showing compliance with -30dBc limit from 2390 MHz to 2400 MHz. Radiated measurements used to show compliance with the limits in the restricted band below 2390 MHz.

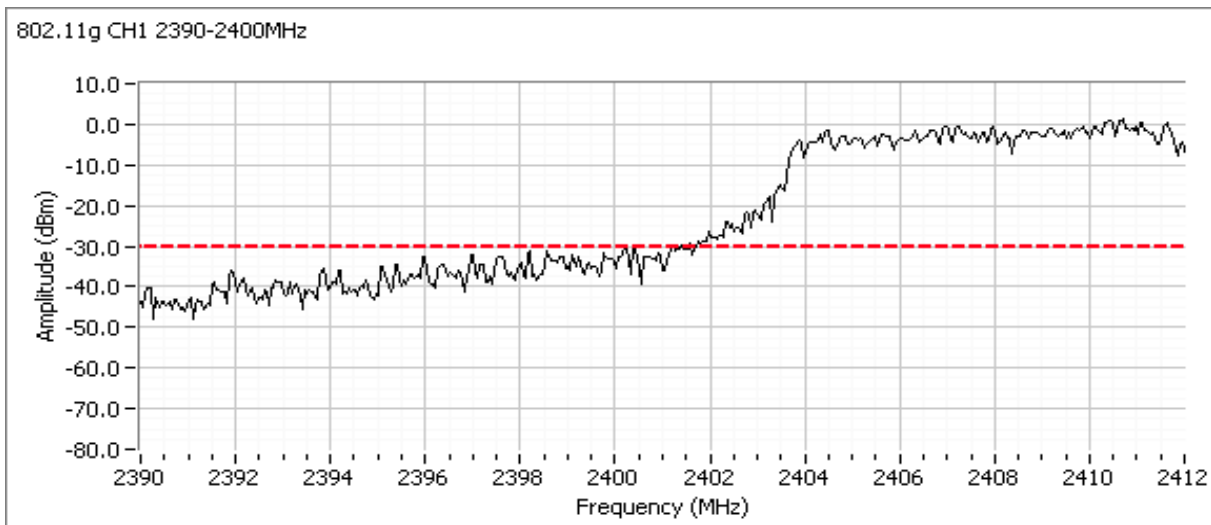

Client:	Summit Data Communications	Job Number:	J78403
Model:	SDC-MSD40NBT (1x1 802.11abg + BT 2.1)	T-Log Number:	T83195
Contact:	Ron Seide	Account Manager:	Christine Krebill
Standard:	FCC 15.247/RSS-210	Class:	N/A

Plots for center channel, power setting = default

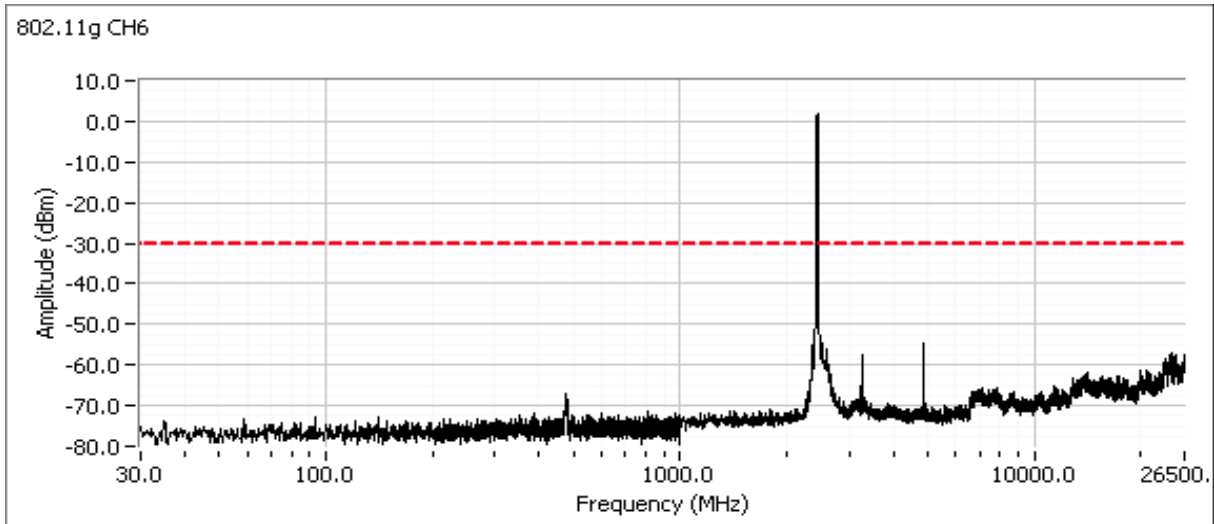

Plots for high channel, power setting = default

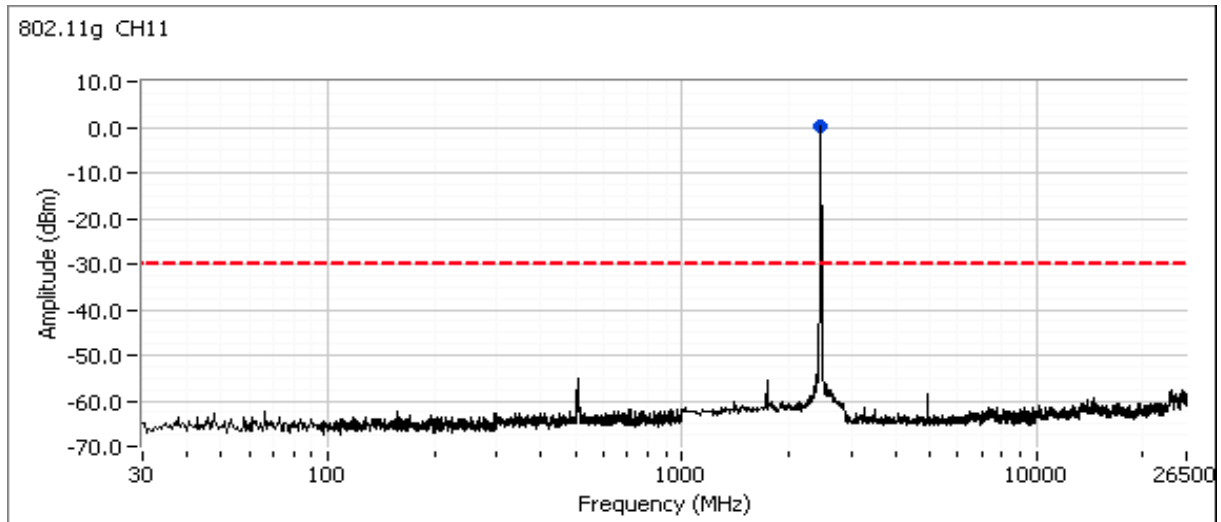

Client:	Summit Data Communications	Job Number:	J78403
Model:	SDC-MSD40NBT (1x1 802.11abg + BT 2.1)	T-Log Number:	T83195
		Account Manager:	Christine Krebill
Contact:	Ron Seide		
Standard:	FCC 15.247/RSS-210	Class:	N/A

**RSS 210 and FCC 15.247 (DTS) Antenna Port Measurements (2.4GHz - 802.11n20)
Power, PSD, Bandwidth and Spurious Emissions**

Test Specific Details

Objective: The objective of this test session is to perform final qualification testing of the EUT with respect to the specification listed above.

Date of Test: 2/6/2012
Test Engineer: Joseph Cadigal
Test Location: FT Lab #4

Config. Used: 2
Config Change: no antennas
EUT Voltage: 3.3 VDC

General Test Configuration

The EUT was connected to the spectrum analyzer or power meter via a suitable attenuator. All measurements were made on a single chain.

All measurements have been corrected to allow for the external attenuators used.

Ambient Conditions:

Temperature: 23 °C
Rel. Humidity: 37 %

Summary of Results

Run #	Pwr setting	Avg Pwr	Test Performed	Limit	Pass / Fail	Result / Margin
2	default	-	Power spectral Density (PSD)	15.247(d)	Pass	-13.6 dBm/3kHz
3	default	-	Minimum 6dB Bandwidth	15.247(a)	Pass	15.1 MHz
3	default	-	99% Bandwidth	RSS GEN	-	20.1 MHz
4	default	-	Spurious emissions	15.247(b)	Pass	All emissions < -30 dBc

Modifications Made During Testing

No modifications were made to the EUT during testing

Deviations From The Standard

No deviations were made from the requirements of the standard.

Client:	Summit Data Communications	Job Number:	J78403
Model:	SDC-MSD40NBT (1x1 802.11abg + BT 2.1)	T-Log Number:	T83195
Contact:	Ron Seide	Account Manager:	Christine Krebill
Standard:	FCC 15.247/RSS-210	Class:	N/A

Run #2: Power spectral Density

Power Setting	Frequency (MHz)	PSD	Limit dBm/3kHz	Result
		(dBm/3kHz) ^{Note 1}		
100	2412	-15.5	8.0	Pass
100	2437	-13.6	8.0	Pass
100	2462	-14.3	8.0	Pass

Note 1: Power spectral density measured using RB=3 kHz, VB=10kHz, analyzer with peak detector and with a sweep time set to ensure a dwell time of at least 1 second per 3kHz. The measurement is made at the frequency of PPSD determined from preliminary scans using RB=3kHz using multiple sweeps at a faster rate over the 6dB bandwidth of the signal.

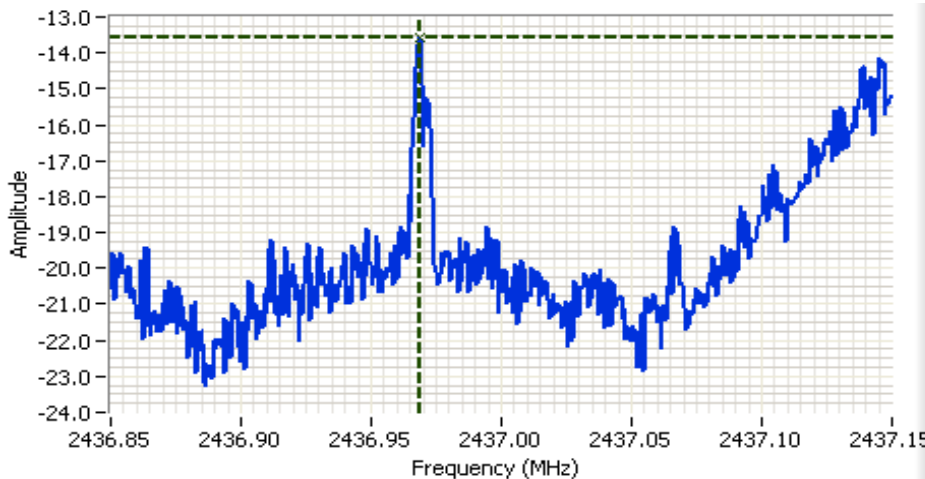

Analyzer Settings
 Agilent Technologies, E4446A
 CF: 2437.000 MHz
 SPAN: 300 kHz
 RB: 3.00 kHz
 VB: 10.0 kHz
 Detector: POS
 Attn: 10 DB
 RL Offset: 11.0 DB
 Sweep Time: 100.0s
 Ref Lvl: 2.0 DBM

Comments

Cursor 1	2436.9690	-13.56	
	0.0000	0.00	

Client:	Summit Data Communications	Job Number:	J78403
Model:	SDC-MSD40NBT (1x1 802.11abg + BT 2.1)	T-Log Number:	T83195
Contact:	Ron Seide	Account Manager:	Christine Krebill
Standard:	FCC 15.247/RSS-210	Class:	N/A

Run #3: Signal Bandwidth

Power Setting	Frequency (MHz)	Resolution Bandwidth	Bandwidth (MHz)	
			6dB	99%
100	2412	100kHz	15.2	19.1
100	2437	100kHz	15.1	20.1
100	2462	100kHz	15.1	18.7

Note 1: 99% bandwidth measured in accordance with RSS GEN, with RB > 1% of the span and VB > 3xRB

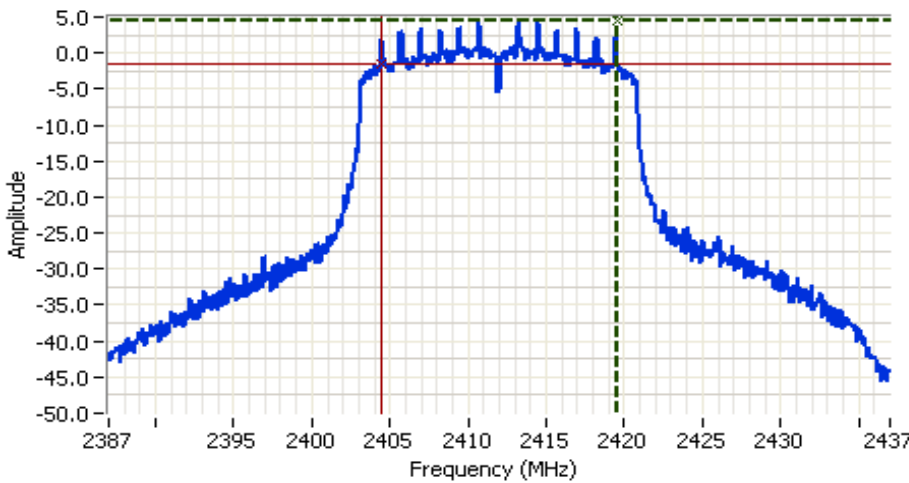

Analyzer Settings
 Agilent Technologies, E4446A
 CF: 2412.000 MHz
 SPAN: 50.000 MHz
 RB: 100 kHz
 VB: 100 kHz
 Detector: POS
 Attn: 10 DB
 RL Offset: 11.0 DB
 Sweep Time: 50.0ms
 Ref Lvl: 11.0 DBM

Comments
 6dB BW: 15.167 MHz

Cursor 1 2419.5833 4.37 

Cursor 2 2404.4167 -1.63 

Delta Freq. 15.167

Delta Amplitude 6.00



Client:	Summit Data Communications	Job Number:	J78403
Model:	SDC-MSD40NBT (1x1 802.11abg + BT 2.1)	T-Log Number:	T83195
Contact:	Ron Seide	Account Manager:	Christine Krebill
Standard:	FCC 15.247/RSS-210	Class:	N/A

Run #4: Out of Band Spurious Emissions

Frequency (MHz)	Limit	Result
2412	-30dBc	Pass
2437	-30dBc	Pass
2462	-30dBc	Pass

Plots for low channel, power setting(s) = default

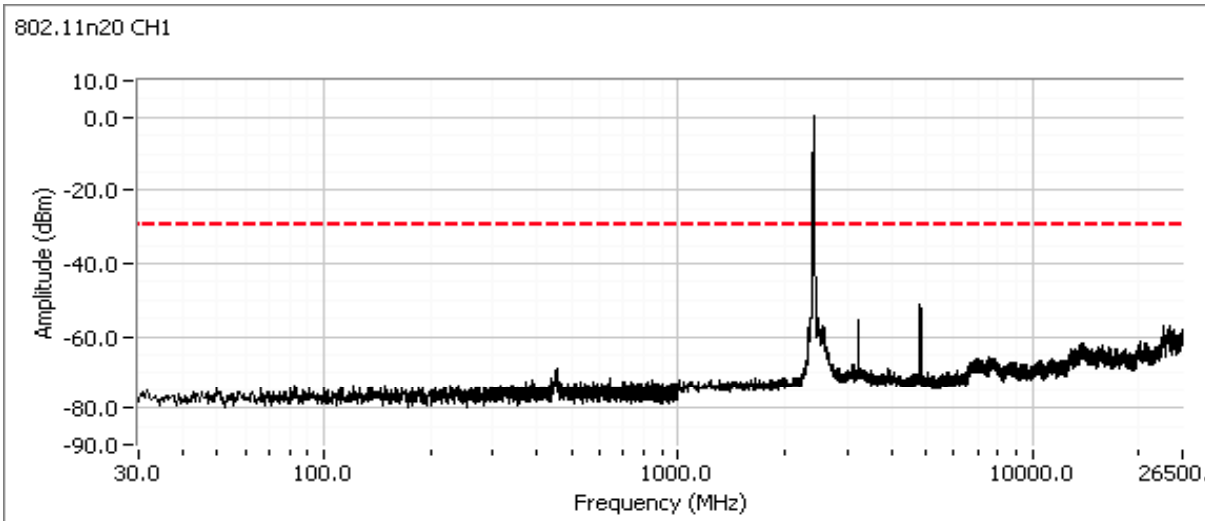

Additional plot showing compliance with -30dBc limit from 2390 MHz to 2400 MHz. Radiated measurements used to show compliance with the limits in the restricted band below 2390 MHz.

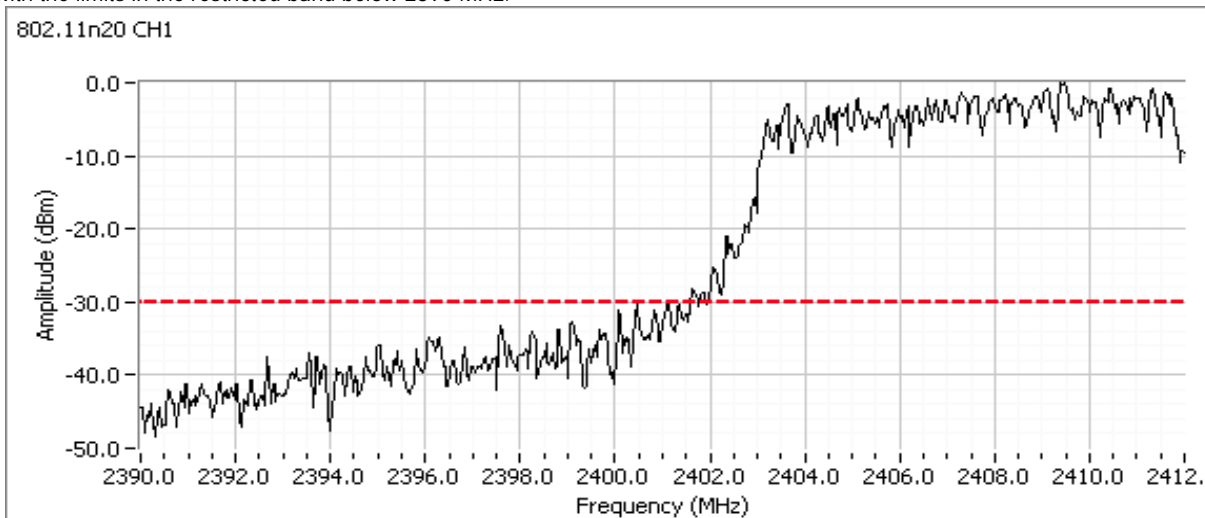

Client:	Summit Data Communications	Job Number:	J78403
Model:	SDC-MSD40NBT (1x1 802.11abg + BT 2.1)	T-Log Number:	T83195
Contact:	Ron Seide	Account Manager:	Christine Krebill
Standard:	FCC 15.247/RSS-210	Class:	N/A

Plots for center channel, power setting(s) = default

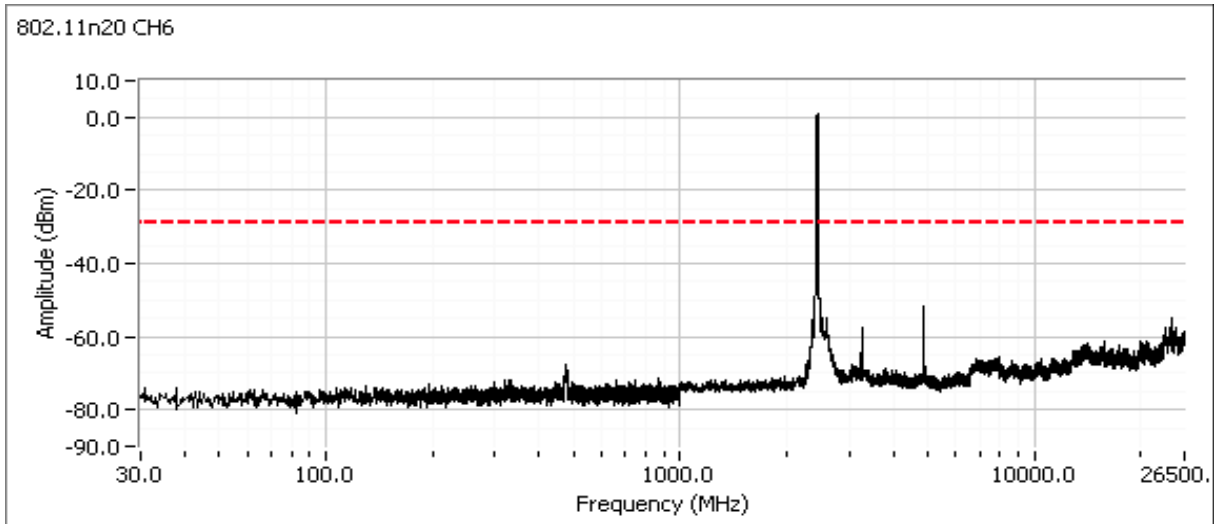

Plots for high channel, power setting(s) = default

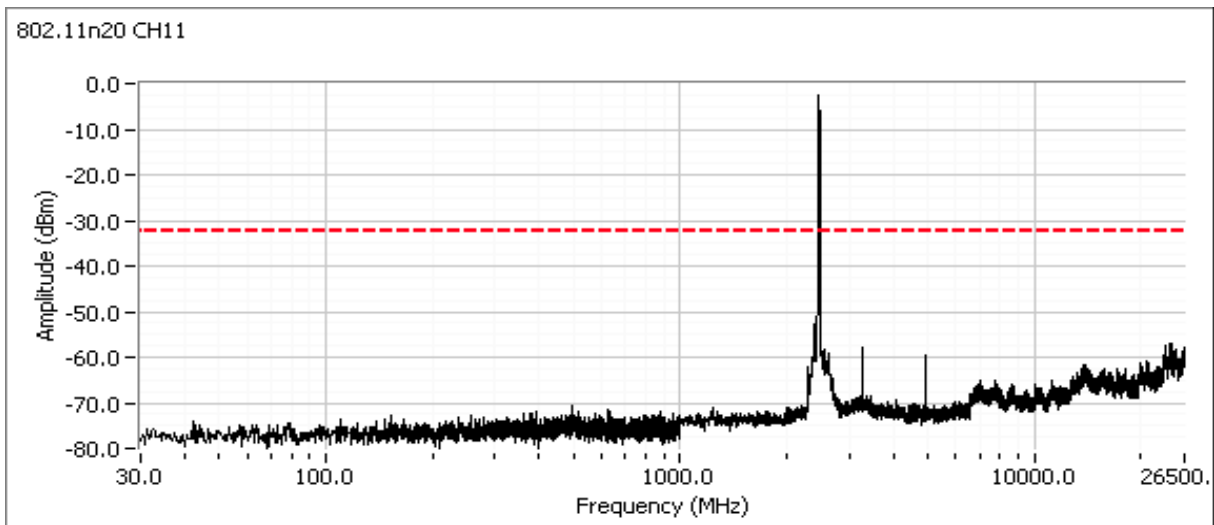

Client:	Summit Data Communications	Job Number:	J78403
Model:	SDC-MSD40NBT (1x1 802.11abg + BT 2.1)	T-Log Number:	T83195
		Account Manager:	Christine Krebill
Contact:	Ron Seide		
Standard:	FCC 15.247/RSS-210	Class:	N/A

**RSS 210 and FCC 15.247 (DTS) Antenna Port Measurements (5GHz - 802.11a)
Power, PSD, Bandwidth and Spurious Emissions**

Test Specific Details

Objective: The objective of this test session is to perform final qualification testing of the EUT with respect to the specification listed above.

Date of Test: 2/8/2012
Test Engineer: Joseph Cadigal
Test Location: FT Lab #4

Config. Used: 2
Config Change: no antennas
EUT Voltage: 3.3 VDC

General Test Configuration

The EUT was connected to the spectrum analyzer or power meter via a suitable attenuator. All measurements were made on a single chain.

All measurements have been corrected to allow for the external attenuators used.

Ambient Conditions:

Temperature: 23 °C
Rel. Humidity: 37 %

Summary of Results

Run #	Pwr setting	Avg Pwr	Test Performed	Limit	Pass / Fail	Result / Margin
2	100%		Power spectral Density (PSD)	15.247(d)	Pass	-16.6 dBm/3kHz
3	100%		Minimum 6dB Bandwidth	15.247(a)	Pass	15.0 MHz
3	100%		99% Bandwidth	RSS GEN	-	18.9 MHz
4	100%		Spurious emissions	15.247(b)	Pass	All emissions < -30 dBc

Modifications Made During Testing

No modifications were made to the EUT during testing

Deviations From The Standard

No deviations were made from the requirements of the standard.

Client:	Summit Data Communications	Job Number:	J78403
Model:	SDC-MSD40NBT (1x1 802.11abg + BT 2.1)	T-Log Number:	T83195
Contact:	Ron Seide	Account Manager:	Christine Krebill
Standard:	FCC 15.247/RSS-210	Class:	N/A

Run #2: Power spectral Density

Power Setting	Frequency (MHz)	PSD	Limit dBm/3kHz	Result
		(dBm/3kHz) ^{Note 1}		
100	5745	-17.3	8.0	Pass
100	5785	-19.8	8.0	Pass
100	5805	-16.6	8.0	Pass

Note 1: Power spectral density measured using RB=3 kHz, VB=10kHz, analyzer with peak detector and with a sweep time set to ensure a dwell time of at least 1 second per 3kHz. The measurement is made at the frequency of PPSD determined from preliminary scans using RB=3kHz using multiple sweeps at a faster rate over the 6dB bandwidth of the signal.

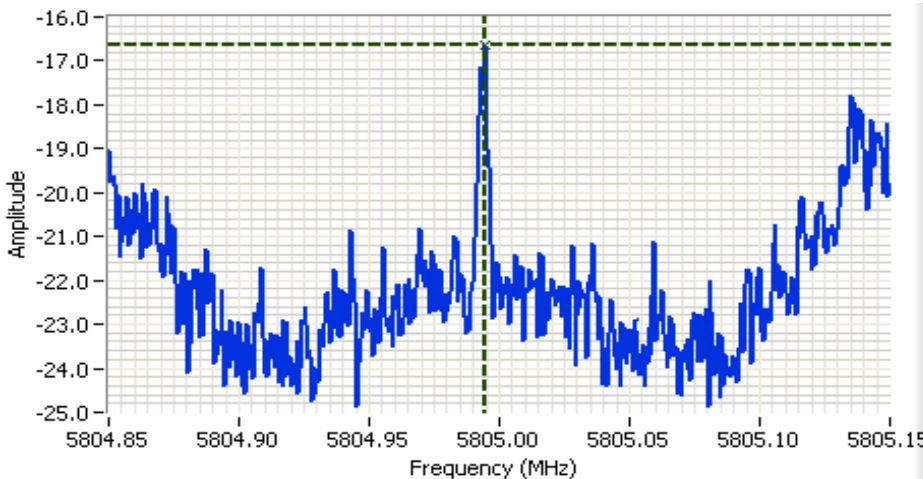

Analyzer Settings
 Agilent Technologies, E4446A
 CF: 5805.000 MHz
 SPAN: 300 kHz
 RB: 3.00 kHz
 VB: 10.0 kHz
 Detector: POS
 Attn: 10 DB
 RL Offset: 11.0 DB
 Sweep Time: 100.0s
 Ref Lvl: 2.0 DBM

Comments

Cursor 1	5804.9945	-16.64	+	-
	0.0000	0.00	+	-



Client:	Summit Data Communications	Job Number:	J78403
Model:	SDC-MSD40NBT (1x1 802.11abg + BT 2.1)	T-Log Number:	T83195
Contact:	Ron Seide	Account Manager:	Christine Krebill
Standard:	FCC 15.247/RSS-210	Class:	N/A

Run #3: Signal Bandwidth

Power Setting	Frequency (MHz)	Resolution Bandwidth	Bandwidth (MHz)	
			6dB	99%
100	5745	100kHz	15.0	18.9
100	5785	100kHz	15.1	18.6
100	5805	100kHz	16.3	18.5

Note 1: 99% bandwidth measured in accordance with RSS GEN, with RB > 1% of the span and VB > 3xRB

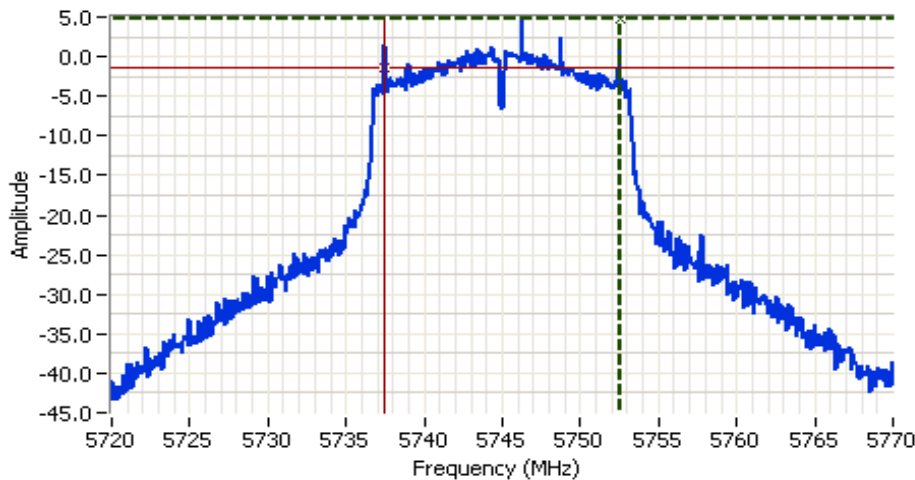

Analyzer Settings
 Agilent Technologies, E4446A
 CF: 5745.000 MHz
 SPAN: 50.000 MHz
 RB: 100 kHz
 VB: 300 kHz
 Detector: POS
 Attn: 10 DB
 RL Offset: 11.0 DB
 Sweep Time: 50.0ms
 Ref Lvl: 11.0 DBM

Comments
 6dB BW: 15.000 MHz

Cursor 1	5752.5000	4.66	
Cursor 2	5737.5000	-1.34	

Delta Freq. 15.000
 Delta Amplitude 6.00



Client:	Summit Data Communications	Job Number:	J78403
Model:	SDC-MSD40NBT (1x1 802.11abg + BT 2.1)	T-Log Number:	T83195
Contact:	Ron Seide	Account Manager:	Christine Krebill
Standard:	FCC 15.247/RSS-210	Class:	N/A

Run #4: Out of Band Spurious Emissions

Frequency (MHz)	Limit	Result
5745	-30dBc	Pass
5785	-30dBc	Pass
5805	-30dBc	Pass

Plots for low channel, power setting(s) = 100%

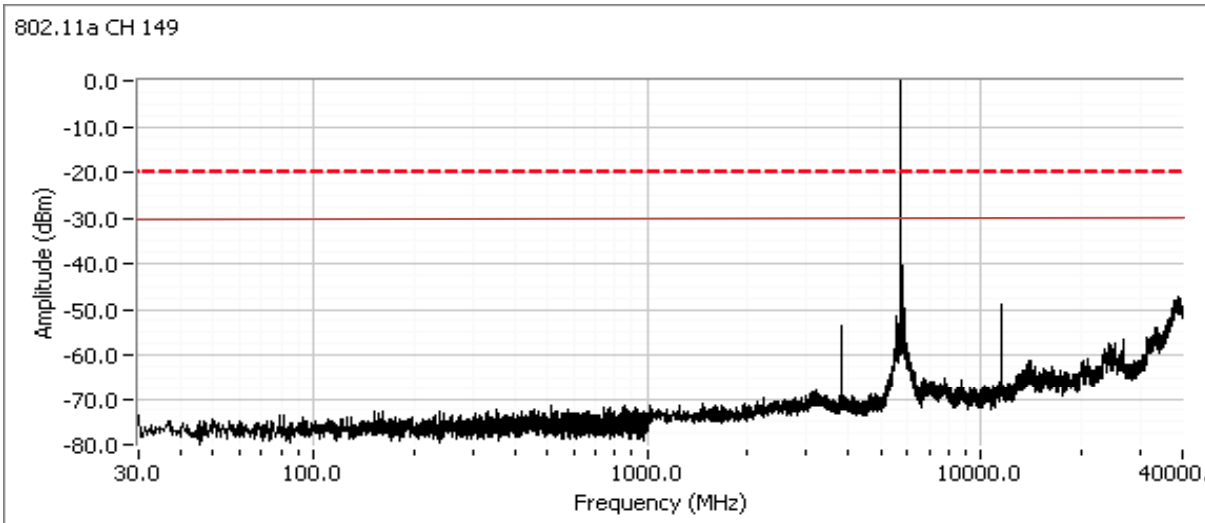

Additional plot from 5715 - 5755 MHz showing compliance with -30dBc at the band edge.

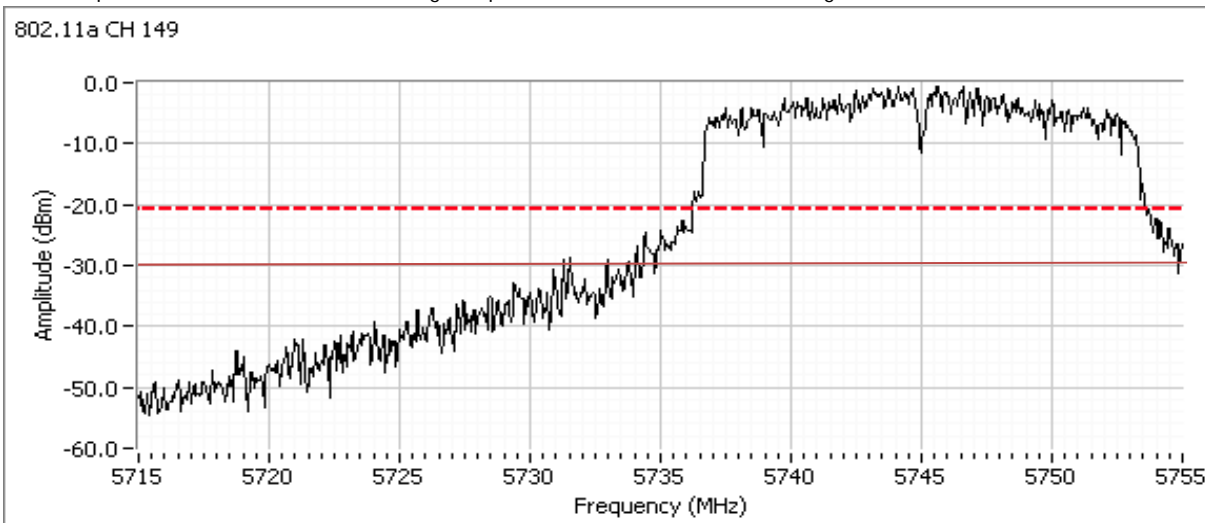

Client:	Summit Data Communications	Job Number:	J78403
Model:	SDC-MSD40NBT (1x1 802.11abg + BT 2.1)	T-Log Number:	T83195
Contact:	Ron Seide	Account Manager:	Christine Krebill
Standard:	FCC 15.247/RSS-210	Class:	N/A

Plots for center channel, power setting(s) = 100%

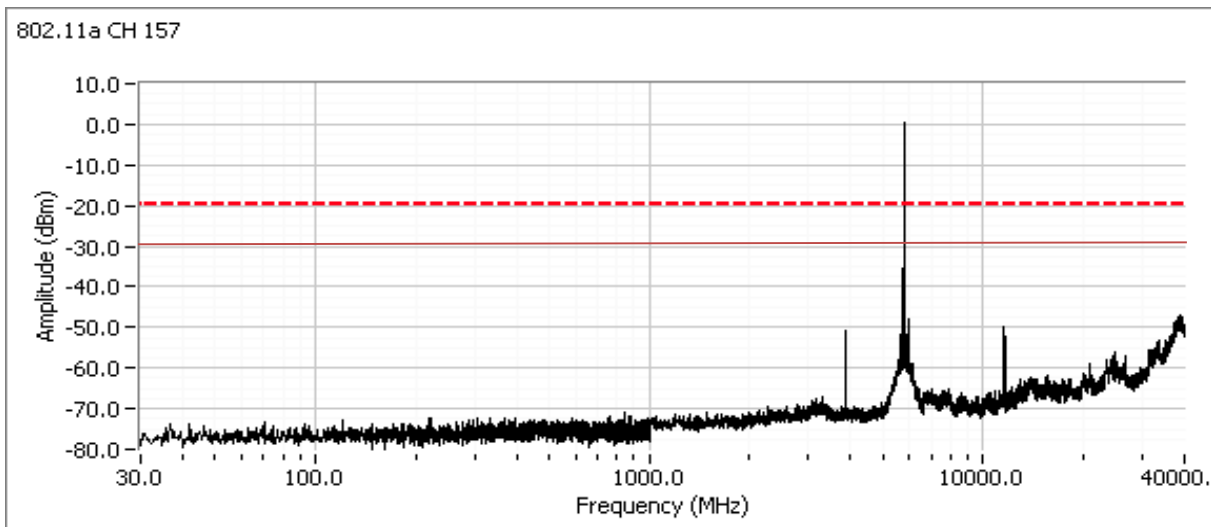

Plots for high channel, power setting(s) = 100%

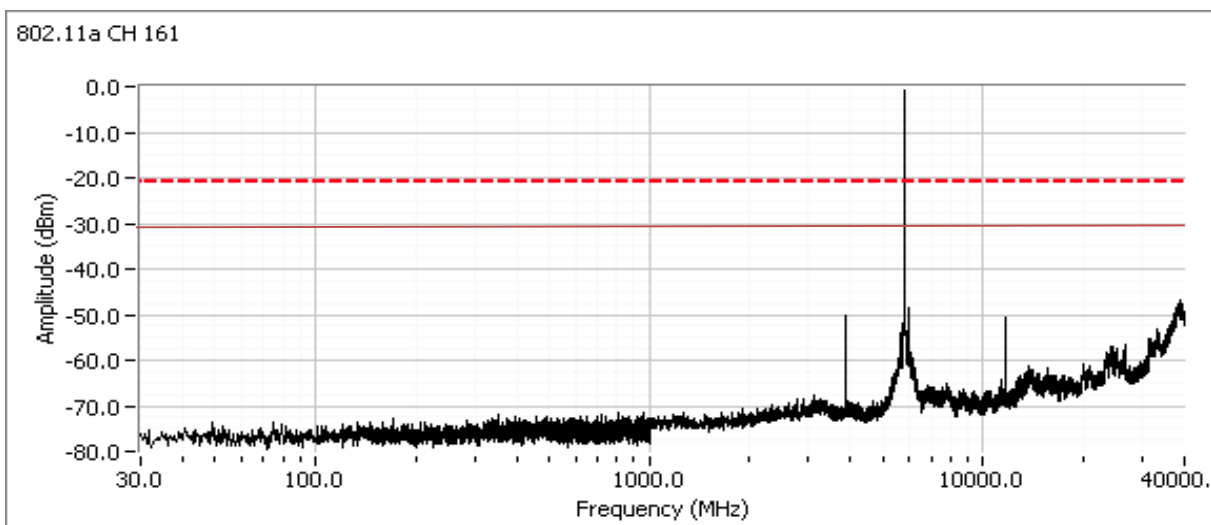

Client:	Summit Data Communications	Job Number:	J78403
Model:	SDC-MSD40NBT (1x1 802.11abg + BT 2.1)	T-Log Number:	T83195
Contact:	Ron Seide	Account Manager:	Christine Krebill
Standard:	FCC 15.247/RSS-210	Class:	N/A

Additional plot from 5820 - 5860 MHz showing compliance with -30dBc at the band edge.

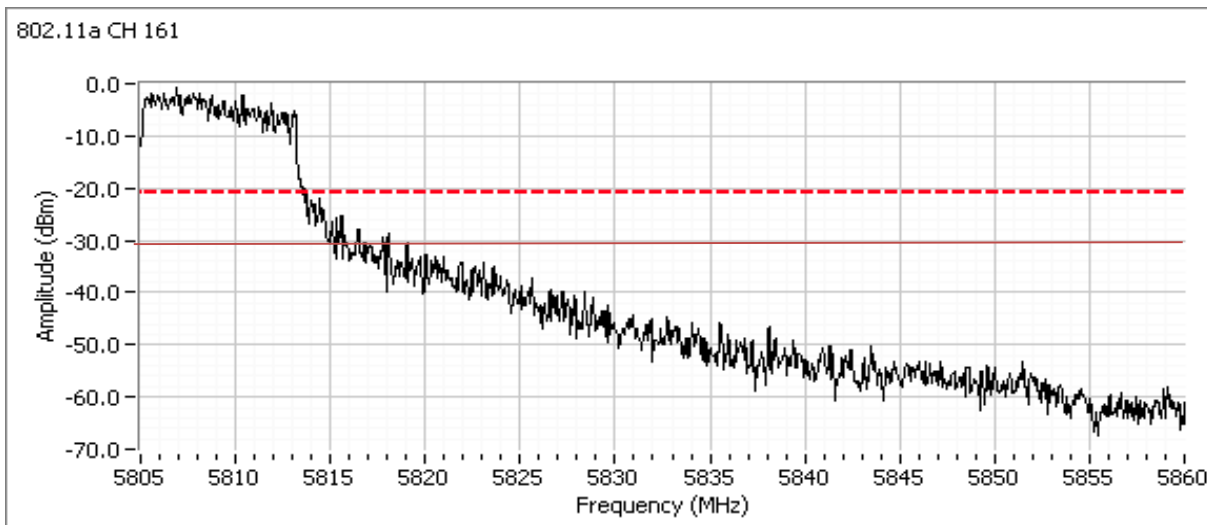

Client:	Summit Data Communications	Job Number:	J78403
Model:	SDC-MSD40NBT (1x1 802.11abg + BT 2.1)	T-Log Number:	T83195
		Account Manager:	Christine Krebill
Contact:	Ron Seide		
Standard:	FCC 15.247/RSS-210	Class:	N/A

**RSS 210 and FCC 15.247 (DTS) Antenna Port Measurements (5GHz - 802.11n20)
Power, PSD, Bandwidth and Spurious Emissions**

Test Specific Details

Objective: The objective of this test session is to perform final qualification testing of the EUT with respect to the specification listed above.

Date of Test: 2/6/2012
Test Engineer: Joseph Cadigal
Test Location: FT Lab #4

Config. Used: 2
Config Change: no antennas
EUT Voltage: 3.3 VDC

General Test Configuration

The EUT was connected to the spectrum analyzer or power meter via a suitable attenuator. All measurements were made on a single chain.

All measurements have been corrected to allow for the external attenuators used.

Ambient Conditions:

Temperature: 23 °C
Rel. Humidity: 37 %

Summary of Results

Run #	Pwr setting	Avg Pwr	Test Performed	Limit	Pass / Fail	Result / Margin
2	Default	-	Power spectral Density (PSD)	15.247(d)	Pass	-11.1 dBm/3kHz
3	Default	-	Minimum 6dB Bandwidth	15.247(a)	Pass	15.0 MHz
3	Default	-	99% Bandwidth	RSS GEN	-	22.8 MHz
4	Default	-	Spurious emissions	15.247(b)	Pass	All emissions < -30 dBc

Modifications Made During Testing

No modifications were made to the EUT during testing

Deviations From The Standard

No deviations were made from the requirements of the standard.

Client: Summit Data Communications	Job Number: J78403
Model: SDC-MSD40NBT (1x1 802.11abg + BT 2.1)	T-Log Number: T83195
	Account Manager: Christine Krebill
Contact: Ron Seide	
Standard: FCC 15.247/RSS-210	Class: N/A

Run #2: Power spectral Density

Power Setting	Frequency (MHz)	PSD	Limit dBm/3kHz	Result
		(dBm/3kHz) ^{Note 1}		
100	5745	-11.1	8.0	Pass
100	5785	-13.9	8.0	Pass
100	5805	-14.3	8.0	Pass

Note 1: Power spectral density measured using RB=3 kHz, VB=10kHz, analyzer with peak detector and with a sweep time set to ensure a dwell time of at least 1 second per 3kHz. The measurement is made at the frequency of PPSD determined from preliminary scans using RB=3kHz using multiple sweeps at a faster rate over the 6dB bandwidth of the signal.

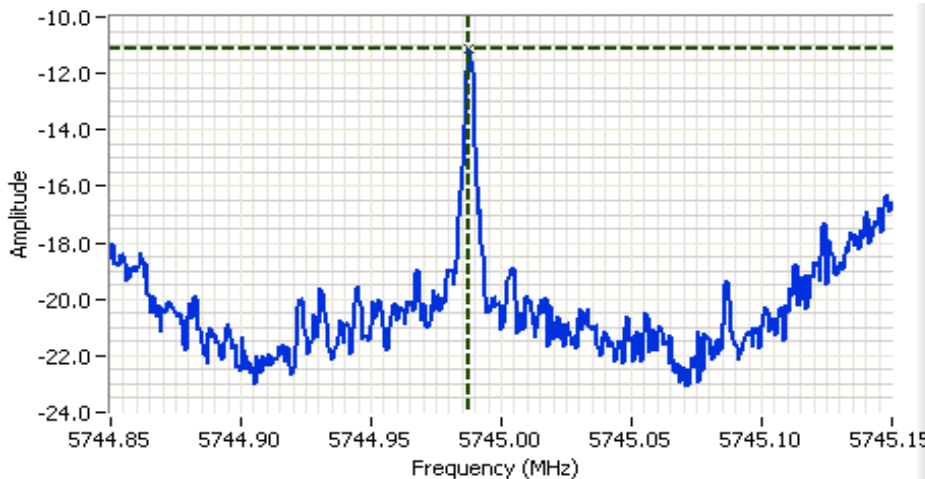

Analyzer Settings

- Rohde&Schwarz, ESI
- CF: 5745.000 MHz
- SPAN: 300 kHz
- RB: 3.00 kHz
- VB: 10.0 kHz
- Detector: POS
- Attn: 20 DB
- RL Offset: 10.5 DB
- Sweep Time: 100.0s
- Ref Lvl: 18.5 DBM

Comments

PSD = -11.12 dBm/3kHz
802.11n20

Cursor 1 5744.9877 -11.12

0.0000 0.00



Client:	Summit Data Communications	Job Number:	J78403
Model:	SDC-MSD40NBT (1x1 802.11abg + BT 2.1)	T-Log Number:	T83195
Contact:	Ron Seide	Account Manager:	Christine Krebill
Standard:	FCC 15.247/RSS-210	Class:	N/A

Run #3: Signal Bandwidth

Power Setting	Frequency (MHz)	Resolution Bandwidth	Bandwidth (MHz)	
			6dB	99%
100	5745	100kHz	15.0	16.9
100	5785	100kHz	15.2	22.8
100	5805	100kHz	15.1	21.4

Note 1: 99% bandwidth measured in accordance with RSS GEN, with RB > 1% of the span and VB > 3xRB

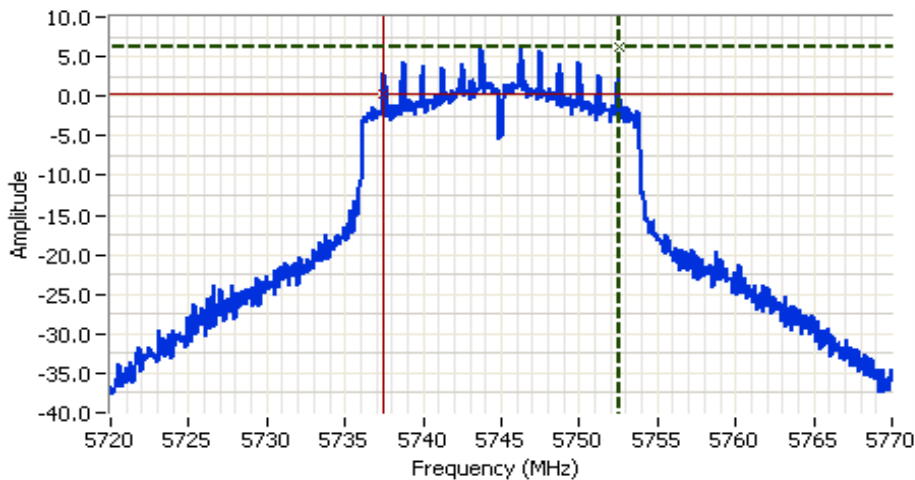

Analyzer Settings
 Agilent Technologies, E4446A
 CF: 5745.000 MHz
 SPAN: 50.000 MHz
 RB: 100 kHz
 VB: 100 kHz
 Detector: POS
 Attn: 10 DB
 RL Offset: 11.0 DB
 Sweep Time: 50.0ms
 Ref Lvl: 11.0 DBM

Comments
 6dB BW: 15.000 MHz

Cursor 1	5752.5000	6.30	
Cursor 2	5737.5000	0.30	

Delta Freq. 15.000
 Delta Amplitude 6.00



Client:	Summit Data Communications	Job Number:	J78403
Model:	SDC-MSD40NBT (1x1 802.11abg + BT 2.1)	T-Log Number:	T83195
Contact:	Ron Seide	Account Manager:	Christine Krebill
Standard:	FCC 15.247/RSS-210	Class:	N/A

Run #4: Out of Band Spurious Emissions

Frequency (MHz)	Limit	Result
5745	-30dBc	Pass
5785	-30dBc	Pass
5805	-30dBc	Pass

Plots for low channel, power setting(s) = 100%

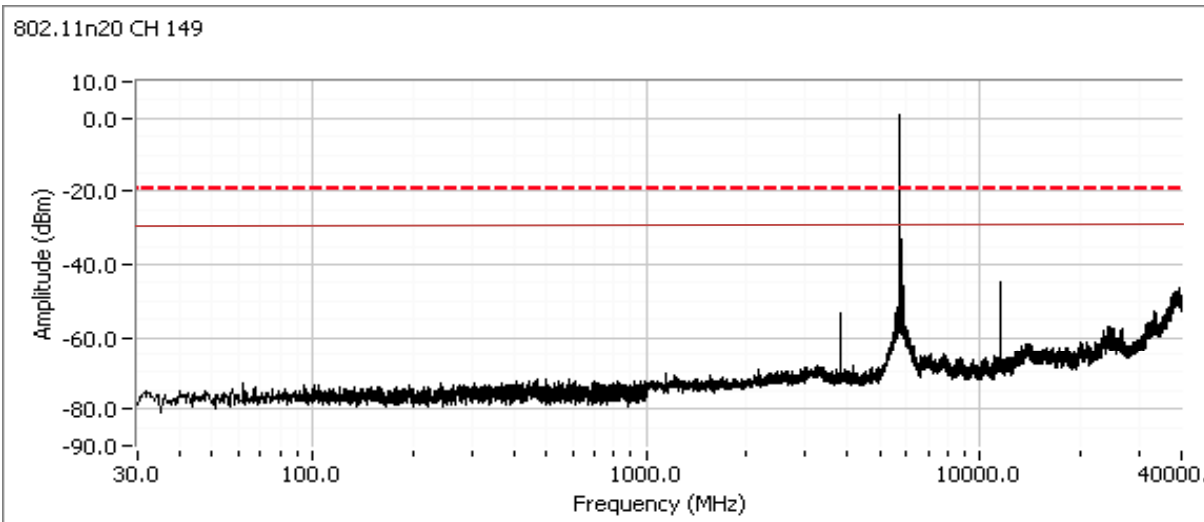

Additional plot from 5715 - 5755 MHz showing compliance with -30dBc at the band edge.

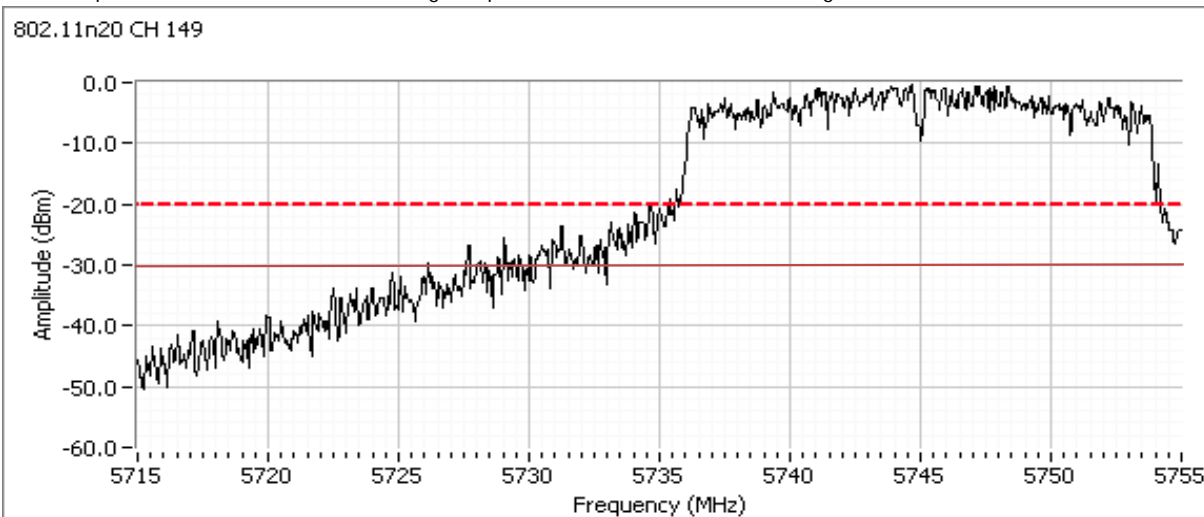

Client:	Summit Data Communications	Job Number:	J78403
Model:	SDC-MSD40NBT (1x1 802.11abg + BT 2.1)	T-Log Number:	T83195
Contact:	Ron Seide	Account Manager:	Christine Krebill
Standard:	FCC 15.247/RSS-210	Class:	N/A

Plots for center channel, power setting(s) = 100%

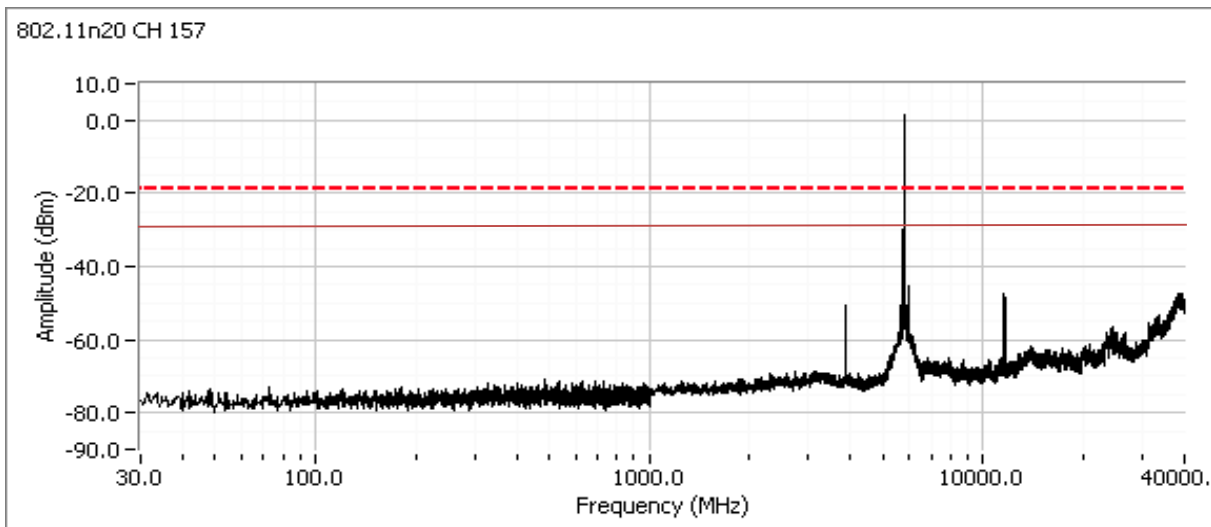

Plots for high channel, power setting(s) = 100%

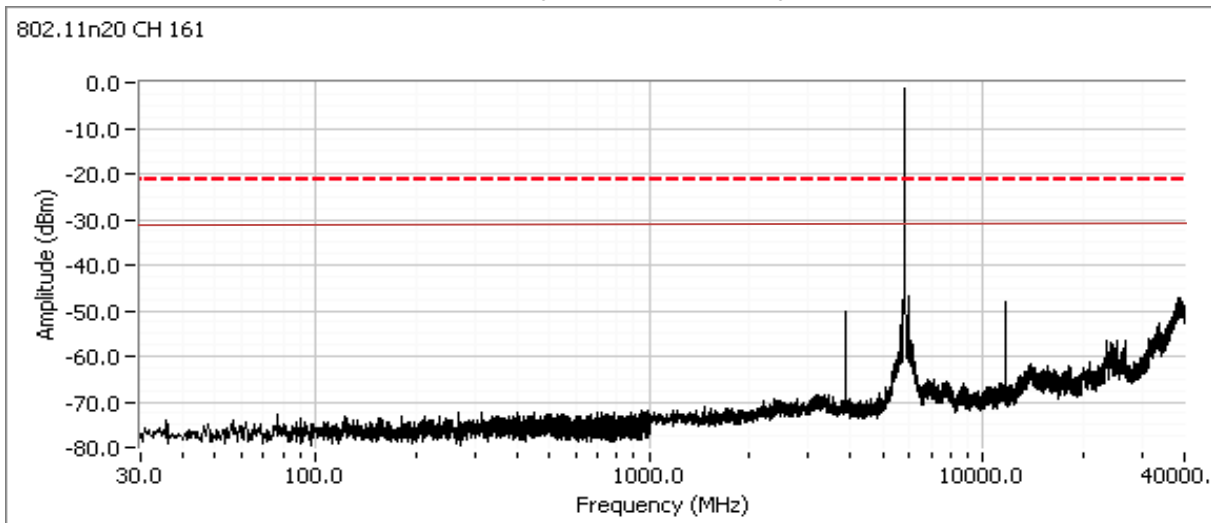

Client:	Summit Data Communications	Job Number:	J78403
Model:	SDC-MSD40NBT (1x1 802.11abg + BT 2.1)	T-Log Number:	T83195
Contact:	Ron Seide	Account Manager:	Christine Krebill
Standard:	FCC 15.247/RSS-210	Class:	N/A

Additional plot from 5820 - 5860 MHz showing compliance with -30dBc at the band edge.

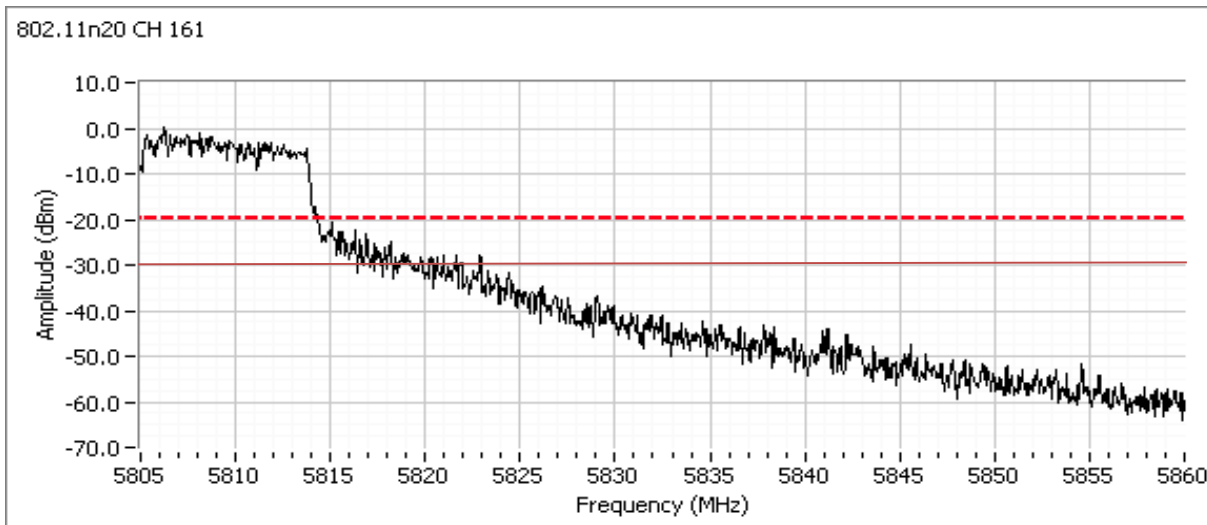

Client:	Summit Data Communications	Job Number:	J78403
Model:	SDC-WB40 and SDC-MSD40NBT (1x1 802.11abg + BT 2.1)	T-Log Number:	T83198
Contact:	Ron Seide	Account Manager:	Christine Krebill
Emissions Standard(s):	EN 301 489-1 V1.8.1/ FCC Part 15B	Class:	B
Immunity Standard(s):	EN 301 489-1 V1.8.1	Environment:	-

EMC Test Data

For The

Summit Data Communications

Model

SDC-WB40 and SDC-MSD40NBT (1x1 802.11abg + BT 2.1)

Date of Last Test: 12/16/2011

Client:	Summit Data Communications	Job Number:	J78403
Model:	SDC-WB40 and SDC-MSD40NBT (1x1 802.11abg + BT 2.1)	T-Log Number:	T83198
		Account Manager:	Christine Krebill
Contact:	Ron Seide		
Standard:	EN 301 489-1 V1.8.1/ FCC Part 15B	Class:	B

Conducted Emissions

(Elliott Laboratories Fremont Facility, Semi-Anechoic Chamber)

Test Specific Details

Objective: The objective of this test session is to perform final qualification testing of the EUT with respect to the specification listed above.

Date of Test: 12/16/2011
 Test Engineer: John Caizzi
 Test Location: Fremont Chamber #5

Config. Used: 2
 Config Change: none
 Host Unit Voltage 120V / 60Hz & 230V / 50Hz

General Test Configuration

For tabletop equipment, the EUT host system was located on a wooden table inside the semi-anechoic chamber, 40 cm from a vertical coupling plane and 80cm from the LISN. The EUT was transmitting on 2437 MHz, 802.11g, 6 Mbps.

Ambient Conditions: Temperature: 21 °C
 Rel. Humidity: 33 %

Summary of Results

Run #	Test Performed	Limit	Result	Margin
1	CE, AC Power, 230V/50Hz	Class B	Pass	31.0dBµV @ 0.687MHz (-15.0dB)
2	CE, AC Power, 120V/60Hz	Class B	Pass	31.9dBµV @ 19.501MHz (-18.1dB)

Modifications Made During Testing

No modifications were made to the EUT during testing

Deviations From The Standard

No deviations were made from the requirements of the standard.

Client:	Summit Data Communications	Job Number:	J78403
Model:	SDC-WB40 and SDC-MSD40NBT (1x1 802.11abg + BT 2.1)	T-Log Number:	T83198
Contact:	Ron Seide	Account Manager:	Christine Krebill
Standard:	EN 301 489-1 V1.8.1/ FCC Part 15B	Class:	B

Run #1: AC Power Port Conducted Emissions, 0.15 - 30MHz, 230V/50Hz

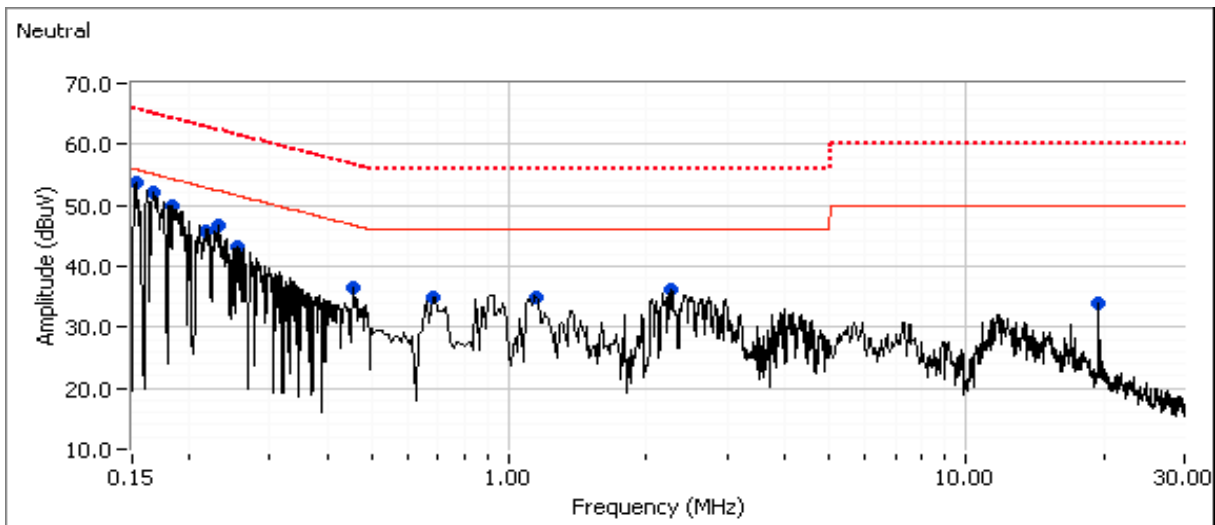
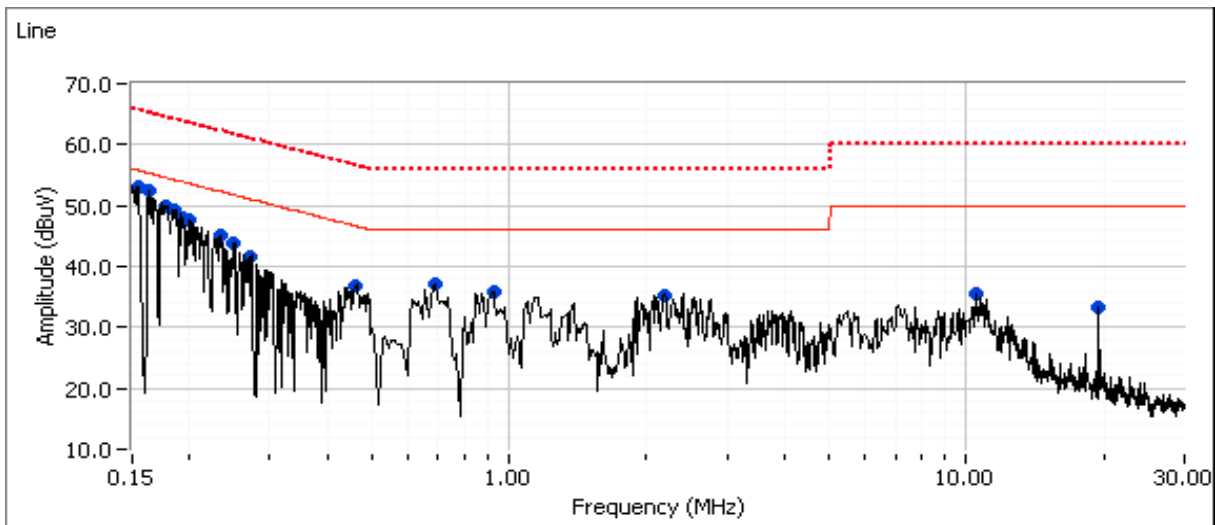



EMC Test Data

Client:	Summit Data Communications	Job Number:	J78403
Model:	SDC-WB40 and SDC-MSD40NBT (1x1 802.11abg + BT 2.1)	T-Log Number:	T83198
Contact:	Ron Seide	Account Manager:	Christine Krebill
Standard:	EN 301 489-1 V1.8.1/ FCC Part 15B	Class:	B

Preliminary peak readings captured during pre-scan (peak readings vs. average limit)

Frequency MHz	Level dB μ V	AC Line	Class B		Detector QP/Ave	Comments
			Limit	Margin		
0.153	53.0	Line	55.8	-2.8	Peak	
0.163	52.3	Line	55.3	-3.0	Peak	
0.178	49.8	Line	54.6	-4.8	Peak	
0.185	49.1	Line	54.3	-5.2	Peak	
0.195	48.1	Line	53.9	-5.8	Peak	
0.202	47.6	Line	53.6	-6.0	Peak	
0.234	45.1	Line	52.3	-7.2	Peak	
0.250	43.9	Line	51.7	-7.8	Peak	
0.687	37.0	Line	46.0	-9.0	Peak	
0.271	41.5	Line	51.1	-9.6	Peak	
0.464	36.9	Line	46.6	-9.7	Peak	
0.916	35.9	Line	46.0	-10.1	Peak	
2.173	35.2	Line	46.0	-10.8	Peak	
10.533	35.6	Line	50.0	-14.4	Peak	
19.501	33.3	Line	50.0	-16.7	Peak	
0.153	53.7	Neutral	55.8	-2.1	Peak	
0.167	52.1	Neutral	55.1	-3.0	Peak	
0.185	49.8	Neutral	54.3	-4.5	Peak	
0.232	46.7	Neutral	52.4	-5.7	Peak	
0.217	45.8	Neutral	52.9	-7.1	Peak	
0.255	43.2	Neutral	51.6	-8.4	Peak	
2.279	36.3	Neutral	46.0	-9.7	Peak	
0.458	36.6	Neutral	46.7	-10.1	Peak	
0.685	35.0	Neutral	46.0	-11.0	Peak	
1.141	34.8	Neutral	46.0	-11.2	Peak	
19.502	34.0	Neutral	50.0	-16.0	Peak	

Client:	Summit Data Communications	Job Number:	J78403
Model:	SDC-WB40 and SDC-MSD40NBT (1x1 802.11abg + BT 2.1)	T-Log Number:	T83198
Contact:	Ron Seide	Account Manager:	Christine Krebill
Standard:	EN 301 489-1 V1.8.1/ FCC Part 15B	Class:	B

Final quasi-peak and average readings

Frequency MHz	Level dB μ V	AC Line	Class B		Detector QP/Ave	Comments
			Limit	Margin		
0.153	17.5	Line	55.8	-38.3	AVG	
0.153	46.1	Line	65.8	-19.7	QP	
0.163	16.8	Line	55.3	-38.5	AVG	
0.163	44.7	Line	65.3	-20.6	QP	
0.178	16.1	Line	54.6	-38.5	AVG	
0.178	42.8	Line	64.6	-21.8	QP	
0.185	15.9	Line	54.3	-38.4	AVG	
0.185	41.8	Line	64.3	-22.5	QP	
0.195	15.7	Line	53.8	-38.1	AVG	
0.195	40.8	Line	63.8	-23.0	QP	
0.202	15.4	Line	53.5	-38.1	AVG	
0.202	40.1	Line	63.5	-23.4	QP	
0.687	31.0	Line	46.0	-15.0	AVG	
0.687	36.5	Line	56.0	-19.5	QP	
0.463	25.5	Line	46.6	-21.1	AVG	
0.463	34.1	Line	56.6	-22.5	QP	
0.916	28.9	Line	46.0	-17.1	AVG	
0.916	34.9	Line	56.0	-21.1	QP	
2.173	7.9	Line	46.0	-38.1	AVG	
2.173	33.6	Line	56.0	-22.4	QP	
10.533	20.5	Line	50.0	-29.5	AVG	
10.533	30.6	Line	60.0	-29.4	QP	
19.501	31.1	Line	50.0	-18.9	AVG	
19.501	32.0	Line	60.0	-28.0	QP	
0.153	17.6	Neutral	55.8	-38.2	AVG	
0.153	46.2	Neutral	65.8	-19.6	QP	
0.167	16.5	Neutral	55.1	-38.6	AVG	
0.167	44.3	Neutral	65.1	-20.8	QP	
0.185	15.8	Neutral	54.3	-38.5	AVG	
0.185	42.1	Neutral	64.3	-22.2	QP	
0.232	21.4	Neutral	52.4	-31.0	AVG	
0.232	37.5	Neutral	62.4	-24.9	QP	
0.216	14.6	Neutral	53.0	-38.4	AVG	
0.216	39.2	Neutral	63.0	-23.8	QP	
2.279	25.1	Neutral	46.0	-20.9	AVG	
2.279	32.6	Neutral	56.0	-23.4	QP	
0.458	28.8	Neutral	46.7	-17.9	AVG	
0.458	33.8	Neutral	56.7	-22.9	QP	

Client:	Summit Data Communications	Job Number:	J78403
Model:	SDC-WB40 and SDC-MSD40NBT (1x1 802.11abg + BT 2.1)	T-Log Number:	T83198
		Account Manager:	Christine Krebill
Contact:	Ron Seide		
Standard:	EN 301 489-1 V1.8.1/ FCC Part 15B	Class:	B

Frequency MHz	Level dB μ V	AC Line	Class B		Detector QP/Ave	Comments
			Limit	Margin		
0.685	29.4	Neutral	46.0	-16.6	AVG	
0.685	34.8	Neutral	56.0	-21.2	QP	
1.141	27.7	Neutral	46.0	-18.3	AVG	
1.141	34.5	Neutral	56.0	-21.5	QP	
19.502	30.2	Neutral	50.0	-19.8	AVG	
19.502	31.3	Neutral	60.0	-28.7	QP	

Client:	Summit Data Communications	Job Number:	J78403
Model:	SDC-WB40 and SDC-MSD40NBT (1x1 802.11abg + BT 2.1)	T-Log Number:	T83198
Contact:	Ron Seide	Account Manager:	Christine Krebill
Standard:	EN 301 489-1 V1.8.1/ FCC Part 15B	Class:	B

Run #2: AC Power Port Conducted Emissions, 0.15 - 30MHz, 120V/60Hz

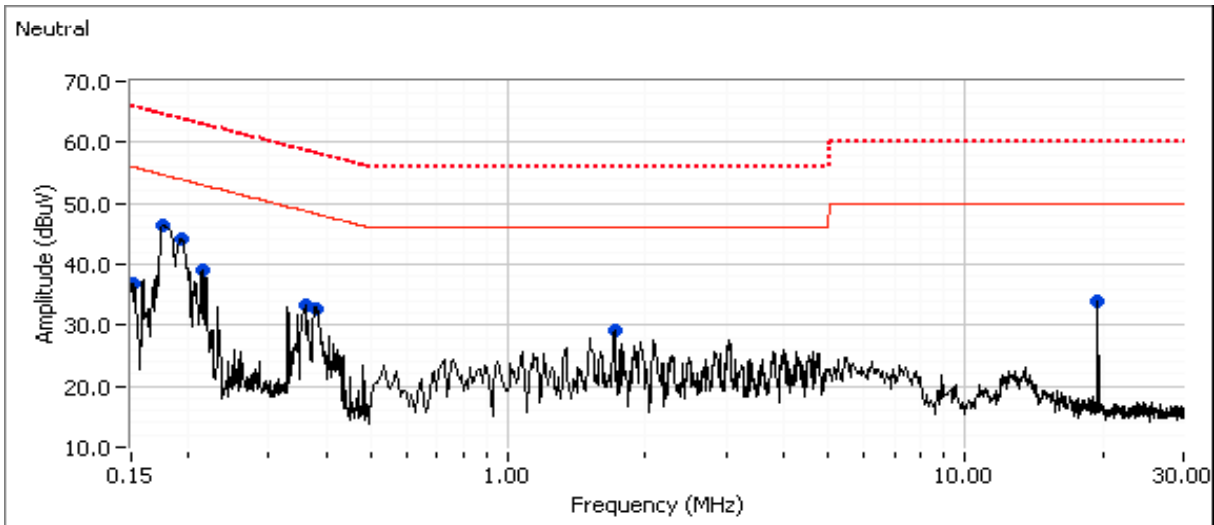
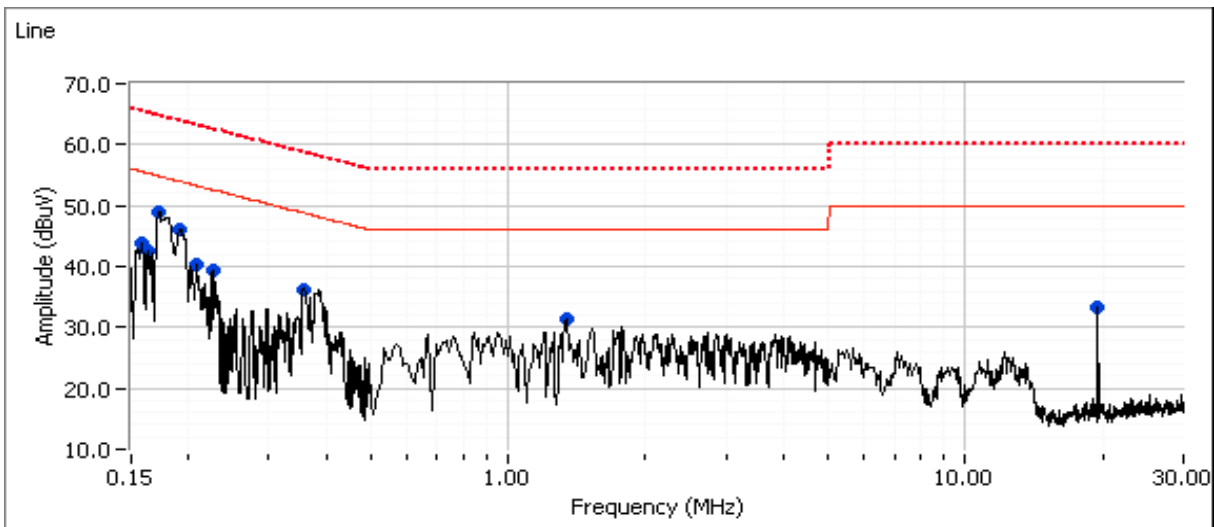



EMC Test Data

Client:	Summit Data Communications	Job Number:	J78403
Model:	SDC-WB40 and SDC-MSD40NBT (1x1 802.11abg + BT 2.1)	T-Log Number:	T83198
		Account Manager:	Christine Krebill
Contact:	Ron Seide		
Standard:	EN 301 489-1 V1.8.1/ FCC Part 15B	Class:	B

Preliminary peak readings captured during pre-scan (peak readings vs. average limit)

Frequency MHz	Level dB μ V	AC Line	Class B		Detector QP/Ave	Comments
			Limit	Margin		
0.173	48.8	Line	54.8	-6.0	Peak	
0.190	46.2	Line	53.9	-7.7	Peak	
0.158	43.8	Line	55.5	-11.7	Peak	
0.357	36.3	Line	48.8	-12.5	Peak	
0.164	42.5	Line	55.3	-12.8	Peak	
0.208	40.4	Line	53.3	-12.9	Peak	
0.225	39.3	Line	52.6	-13.3	Peak	
1.337	31.4	Line	46.0	-14.6	Peak	
19.502	33.2	Line	50.0	-16.8	Peak	
0.176	46.4	Neutral	54.7	-8.3	Peak	
0.192	44.0	Neutral	53.9	-9.9	Peak	
0.213	39.1	Neutral	53.0	-13.9	Peak	
0.379	32.8	Neutral	48.3	-15.5	Peak	
0.360	33.2	Neutral	48.7	-15.5	Peak	
19.501	34.0	Neutral	50.0	-16.0	Peak	
1.717	29.2	Neutral	46.0	-16.8	Peak	
0.152	36.9	Neutral	55.9	-19.0	Peak	

Client:	Summit Data Communications	Job Number:	J78403
Model:	SDC-WB40 and SDC-MSD40NBT (1x1 802.11abg + BT 2.1)	T-Log Number:	T83198
Contact:	Ron Seide	Account Manager:	Christine Krebill
Standard:	EN 301 489-1 V1.8.1/ FCC Part 15B	Class:	B

Final quasi-peak and average readings

Frequency MHz	Level dB μ V	AC Line	Class B		Detector QP/Ave	Comments
			Limit	Margin		
0.173	14.0	Line	54.8	-40.8	AVG	
0.173	44.3	Line	64.8	-20.5	QP	
0.190	33.5	Line	54.0	-20.5	AVG	
0.190	44.4	Line	64.0	-19.6	QP	
0.158	12.7	Line	55.6	-42.9	AVG	
0.158	31.5	Line	65.6	-34.1	QP	
0.357	10.7	Line	48.8	-38.1	AVG	
0.357	32.2	Line	58.8	-26.6	QP	
0.164	14.3	Line	55.3	-41.0	AVG	
0.164	41.0	Line	65.3	-24.3	QP	
0.208	16.0	Line	53.3	-37.3	AVG	
0.208	34.6	Line	63.3	-28.7	QP	
0.225	11.7	Line	52.6	-40.9	AVG	
0.225	23.9	Line	62.6	-38.7	QP	
1.337	21.3	Line	46.0	-24.7	AVG	
1.337	29.5	Line	56.0	-26.5	QP	
19.502	29.8	Line	50.0	-20.2	AVG	
19.502	30.4	Line	60.0	-29.6	QP	
0.176	16.4	Neutral	54.7	-38.3	AVG	
0.176	44.4	Neutral	64.7	-20.3	QP	
0.192	27.9	Neutral	53.9	-26.0	AVG	
0.192	42.6	Neutral	63.9	-21.3	QP	
0.213	12.2	Neutral	53.1	-40.9	AVG	
0.213	33.1	Neutral	63.1	-30.0	QP	
0.379	23.7	Neutral	48.3	-24.6	AVG	
0.379	30.7	Neutral	58.3	-27.6	QP	
0.360	17.3	Neutral	48.7	-31.4	AVG	
0.360	29.3	Neutral	58.7	-29.4	QP	
19.501	31.9	Neutral	50.0	-18.1	AVG	
19.501	32.6	Neutral	60.0	-27.4	QP	
1.717	10.7	Neutral	46.0	-35.3	AVG	
1.717	18.8	Neutral	56.0	-37.2	QP	
0.152	11.4	Neutral	55.9	-44.5	AVG	
0.152	30.6	Neutral	65.9	-35.3	QP	

End of Report

This page is intentionally blank and marks the last page of this test report.