

# FCC C2PC Test Report

**FCC ID** : SQG-WB45NBT  
**Equipment** : 45 Series WB module with Bluetooth  
**Model No.** : WB45NBT  
**Brand Name** : Laird Technologies  
**Applicant** : Laird Technologies  
**Address** : 11160 Thompson Ave. / Lenexa, Kansas /  
66219 / USA  
**Standard** : 47 CFR FCC Part 15.247  
**Received Date** : Jul. 29, 2015  
**Tested Date** : Aug. 14 ~ Aug. 17, 2015

We, International Certification Corp., would like to declare that the tested sample has been evaluated and in compliance with the requirement of the above standards. The test results contained in this report refer exclusively to the product. It may be duplicated completely for legal use with the approval of the applicant. It shall not be reproduced except in full without the written approval of our laboratory.

Approved & Reviewed by:

  
\_\_\_\_\_  
Gary Chang / Manager



---

## Table of Contents

<b>1</b>	<b>GENERAL DESCRIPTION .....</b>	<b>5</b>
1.1	Information.....	5
1.2	Local Support Equipment List .....	7
1.3	Test Setup Chart .....	7
1.4	The Equipment List .....	8
1.5	Test Standards .....	9
1.6	Measurement Uncertainty .....	9
<b>2</b>	<b>TEST CONFIGURATION .....</b>	<b>10</b>
2.1	Testing Condition .....	10
2.2	The Worst Test Modes and Channel Details .....	10
<b>3</b>	<b>TRANSMITTER TEST RESULTS.....</b>	<b>11</b>
3.1	Conducted Emissions.....	11
3.2	Unwanted Emissions into Restricted Frequency Bands .....	14
<b>4</b>	<b>TEST LABORATORY INFORMATION .....</b>	<b>22</b>

---

## Release Record

Report No.	Version	Description	Issued Date
FR350301-01AD	Rev. 01	Initial issue	Sep. 15, 2015

## Summary of Test Results

FCC Rules	Test Items	Measured	Result
15.207	AC Power Line Conducted Emissions	[dBuV]: 0.162MHz 48.87 (Margin -16.47dB) - QP	Pass
15.247(d) 15.209	Radiated Emissions	[dBuV/m at 3m]: 36.79MHz 36.84 (Margin -3.16dB) - QP	Pass

# 1 General Description

## 1.1 Information

This report is prepared for FCC class II permissive change.

This report is issued as a supplementary report to original ICC report no. FR350301AD. The modification is concerned with following:

- ✧ Additional Dipole antennas.
- ✧ Remove components to cancel BT / Wi-Fi diversity function and replace components for NAND flash.

Removed part is not the worst case of original test report, thus only conducted emission and radiated emission below 1GHz tests had been tested and presented in following sections.

### 1.1.1 Specification of the Equipment under Test (EUT)

RF General Information				
Frequency Range (MHz)	Bluetooth Mode	Ch. Frequency (MHz)	Channel Number	Data Rate
2400-2483.5	BR V2.1	2402-2480	0-78 [79]	1 Mbps
2400-2483.5	EDR V2.1	2402-2480	0-78 [79]	2 Mbps
2400-2483.5	EDR V2.1	2402-2480	0-78 [79]	3 Mbps

Note 1: RF output power specifies that Maximum Peak Conducted Output Power.  
 Note 2: Bluetooth BR uses a GFSK.  
 Note 3: Bluetooth EDR uses a combination of  $\pi/4$ -DQPSK and 8DPSK.

### 1.1.2 Antenna Details (The additional antennas were marked in boldface.)

Ant. No.	Brand /Model	Type	Connector	Operating Frequencies (MHz) / Antenna Gain (dBi)				
				2400~2483.5	5150~5250	5250~5350	5470~5725	5725~5850
1	MAG.LAYERS EDA-1513-25GR2-B2-CY	Dipole	SMA Jack Reverse	2	2	2	2	2
2	MAG.LAYERS PCA-4606-2G4C1-A13-CY	PCB Dipole	UFL	2.21	2.21	2.21	2.21	2.21
3	Larid NanoBlade-IP04	PCB Dipole	UFL	2	3.9	3.9	4	4
4	Larid MAF95310 Mini NanoBlade Flex	PCB Dipole	UFL	2.79	3.38	3.38	3.38	3.38
5	Larid NanoBlue-IP04	PCB Dipole	UFL	2	---	---	---	---
6	Ethertronics WLAN_1000146	PIFA	UFL	2.5	3.5	3.5	3.5	3.5
7	<b>SAA MG7018-41-000-R</b>	<b>Dipole</b>	<b>UFL</b>	<b>1.87</b>	<b>0.85</b>	<b>0.6</b>	<b>0.94</b>	<b>0.92</b>
8	<b>SAA MG7324-41-000-R</b>	<b>Dipole</b>	<b>UFL</b>	<b>1.32</b>	<b>1.04</b>	<b>1.6</b>	<b>2.75</b>	<b>2.24</b>

### 1.1.3 Power Supply Type of Equipment under Test (EUT)

<b>Power Supply Type</b>	3.3Vdc or 1.8Vdc from host.
--------------------------	-----------------------------

### 1.1.4 Accessories

N/A

### 1.1.5 Channel List

Frequency band (MHz)				2400~2483.5			
Channel	Frequency (MHz)	Channel	Frequency (MHz)	Channel	Frequency (MHz)	Channel	Frequency (MHz)
0	2402	20	2422	40	2442	60	2462
1	2403	21	2423	41	2443	61	2463
2	2404	22	2424	42	2444	62	2464
3	2405	23	2425	43	2445	63	2465
4	2406	24	2426	44	2446	64	2466
5	2407	25	2427	45	2447	65	2467
6	2408	26	2428	46	2448	66	2468
7	2409	27	2429	47	2449	67	2469
8	2410	28	2430	48	2450	68	2470
9	2411	29	2431	49	2451	69	2471
10	2412	30	2432	50	2452	70	2472
11	2413	31	2433	51	2453	71	2473
12	2414	32	2434	52	2454	72	2474
13	2415	33	2435	53	2455	73	2475
14	2416	34	2436	54	2456	74	2476
15	2417	35	2437	55	2457	75	2477
16	2418	36	2438	56	2458	76	2478
17	2419	37	2439	57	2459	77	2479
18	2420	38	2440	58	2460	78	2480
19	2421	39	2441	59	2461	---	---

## 1.2 Local Support Equipment List

Support Equipment List					
No.	Equipment	Brand	Model	FCC ID	Signal cable / Length (m)
1	Fixture	---	---	---	---

Note: No.1 was provided by applicant

## 1.3 Test Setup Chart

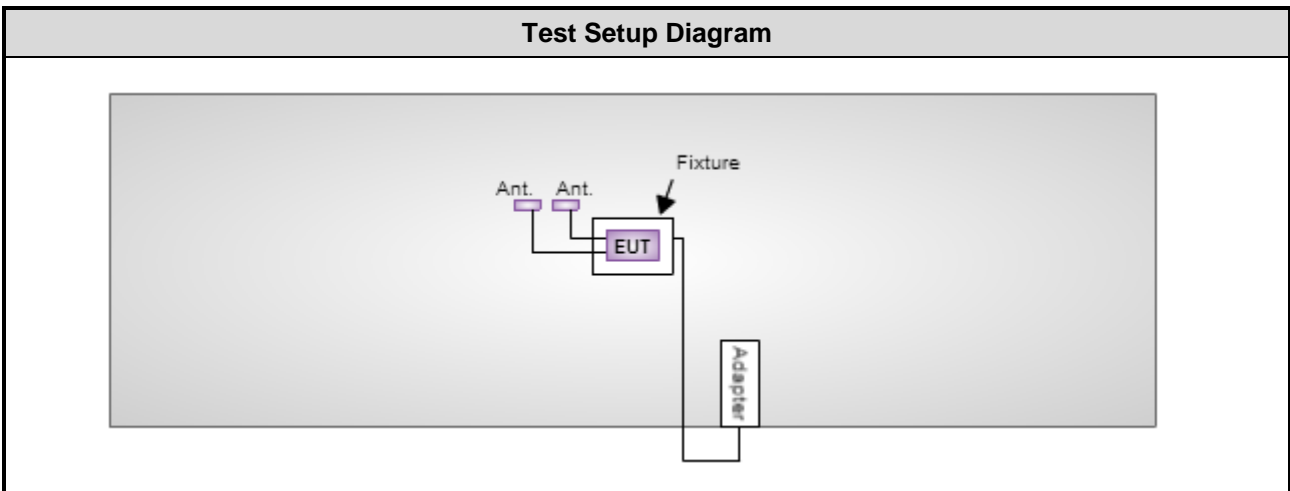

## 1.4 The Equipment List

Test Item	Conducted Emission				
Test Site	Conduction room 1 / (CO01-WS)				
Instrument	Manufacturer	Model No.	Serial No.	Calibration Date	Calibration Until
EMC Receiver	R&S	ESCS 30	100169	Oct. 17, 2014	Oct. 16, 2015
LISN	SCHWARZBECK	Schwarzbeck 8127	8127-667	Nov. 17, 2014	Nov. 16, 2015
RF Cable-CON	Woken	CFD200-NL	CFD200-NL-001	Dec. 31, 2014	Dec. 30, 2015
Measurement Software	AUDIX	e3	6.120210k	NA	NA

Note: Calibration Interval of instruments listed above is one year.

Test Item	Radiated Emission				
Test Site	966 chamber 2 / (03CH02-WS)				
Instrument	Manufacturer	Model No.	Serial No.	Calibration Date	Calibration Until
Spectrum Analyzer	R&S	FSV40	101499	Dec. 31, 2014	Dec. 30, 2015
Receiver	R&S	ESR3	101657	Jan. 15, 2015	Jan. 14, 2016
Bilog Antenna	SCHWARZBECK	VULB9168	VULB9168-524	Oct. 16, 2014	Oct. 15, 2015
Horn Antenna 1G-18G	SCHWARZBECK	BBHA 9120 D	BBHA 9120 D 1095	Oct. 14, 2014	Oct. 13, 2015
Horn Antenna 18G-40G	SCHWARZBECK	BBHA 9170	BBHA 9170517	Nov. 10, 2014	Nov. 09, 2015
Loop Antenna	R&S	HFH2-Z2	11900	Nov. 10, 2014	Nov. 09, 2015
Preamplifier	Burgeon	BPA-530	100218	Nov. 10, 2014	Nov. 09, 2015
Preamplifier	Agilent	83017A	MY39501309	Sep. 29, 2014	Sep. 28, 2015
Preamplifier	EMC	EMC184045B	980192	Aug. 26, 2014	Aug. 25, 2015
RF Cable	HUBER+SUHNER	SUCOFLEX104	MY16140/4	Dec. 16, 2014	Dec. 15, 2015
RF Cable	HUBER+SUHNER	SUCOFLEX104	MY16018/4	Dec. 16, 2014	Dec. 15, 2015
RF Cable	HUBER+SUHNER	SUCOFLEX104	MY16015/4	Dec. 16, 2014	Dec. 15, 2015
LF cable 3M	Woken	CFD400NL-LW	CFD400NL-003	Dec. 16, 2014	Dec. 15, 2015
LF cable 10M	Woken	CFD400NL-LW	CFD400NL-004	Dec. 16, 2014	Dec. 15, 2015
Measurement Software	AUDIX	e3	6.120210g	NA	NA

Note: Calibration Interval of instruments listed above is one year.



## 1.5 Test Standards

According to the specification of EUT, the EUT must comply with following standards and KDB documents.

47 CFR FCC Part 15.247

FCC Public notice DA 00-705

ANSI C63.10-2013

## 1.6 Measurement Uncertainty

ISO/IEC 17025 requires that an estimate of the measurement uncertainties associated with the emissions test results be included in the report. The measurement uncertainties given below are based on a 95% confidence level (based on a coverage factor ( $k=2$ ))

Measurement Uncertainty	
Parameters	Uncertainty
AC conducted emission	$\pm 2.92$ dB
Radiated emission $\leq 1$ GHz	$\pm 3.62$ dB

## 2 Test Configuration

### 2.1 Testing Condition

Test Item	Test Site	Ambient Condition	Tested By
AC Conduction	CO01-WS	22°C / 59%	Kevin Ma
Radiated Emissions	03CH02-WS	22°C / 61%	Anderson Hung

➤ FCC site registration No.: 657002

➤ IC site registration No.: 10807A-2

### 2.2 The Worst Test Modes and Channel Details

Test item	Mode	Test Frequency (MHz)	Data Rate (Mbps)	Test Configuration
Conducted Emissions	8DPSK	2402	3Mbps	2
Radiated Emissions ≤ 1GHz	8DPSK	2402	3Mbps	1, 2, 3

**NOTE:**

1. 3 types antenna are used for this device.
2. The highest gain antenna of each type is selected to perform radiated emissions test as below test configuration.
3. Test configurations are listed as below:
  - 1) Configuration 1: Dipole antenna (Antenna No.1), Y-plane.
  - 2) Configuration 2 : PCB Dipole antenna (Antenna No.4) , Y-plane
  - 3) Configuration 3 : PIFA antenna (Antenna No.6) , Y-plane
4. The EUT supports two DC voltage options, 3.3Vdc and 1.8Vdc. Both options were assessed and 3.3Vdc was found to be the worst case and was selected for the final test.

## 3 Transmitter Test Results

### 3.1 Conducted Emissions

#### 3.1.1 Limit of Conducted Emissions

Conducted Emissions Limit		
Frequency Emission (MHz)	Quasi-Peak	Average
0.15-0.5	66 - 56 *	56 - 46 *
0.5-5	56	46
5-30	60	50

Note 1: \* Decreases with the logarithm of the frequency.

#### 3.1.2 Test Procedures

1. The device is placed on a test table, raised 80 cm above the reference ground plane. The vertical conducting plane is located 40 cm to the rear of the device.
2. The device is connected to line impedance stabilization network (LISN) and other accessories are connected to other LISN. Measured levels of AC power line conducted emission are across the 50  $\Omega$  LISN port.
3. AC conducted emission measurements is made over frequency range from 150 kHz to 30 MHz.
4. This measurement was performed with AC 120V/60Hz

#### 3.1.3 Test Setup



- Note: 1. Support units were connected to second LISN.  
 2. Both of LISNs (AMN) are 80 cm from EUT and at least 80 cm from other units and other metal planes

### 3.1.4 Test Result of Conducted Emissions

<b>Modulation Mode</b>	8DPSK	<b>Test Freq. (MHz)</b>	2402
<b>Power Phase</b>	Line	<b>Test Configuration</b>	2

  

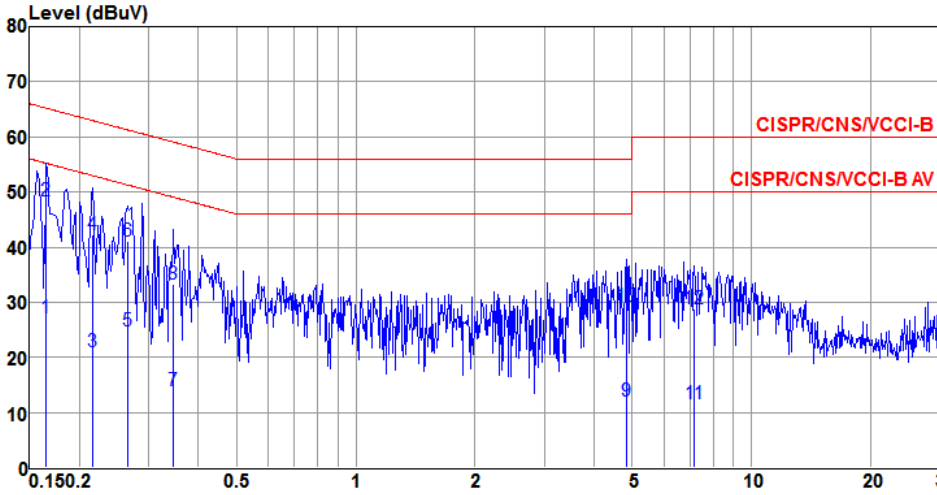

	Freq MHz	Level dBuV	Limit Line dBuV	Over Limit dB	Read Level dBuV	LISN factor dB	cable loss dB	Remark
1	0.165	27.14	55.21	-28.07	26.37	0.69	0.08	Average
2*	0.165	48.35	65.21	-16.86	47.58	0.69	0.08	QP
3	0.216	21.05	52.96	-31.91	20.72	0.24	0.09	Average
4	0.216	42.19	62.96	-20.77	41.86	0.24	0.09	QP
5	0.264	24.88	51.29	-26.41	24.56	0.22	0.10	Average
6	0.264	41.18	61.29	-20.11	40.86	0.22	0.10	QP
7	0.346	13.82	49.05	-35.23	13.52	0.19	0.11	Average
8	0.346	33.38	59.05	-25.67	33.08	0.19	0.11	QP
9	4.822	12.11	46.00	-33.89	11.46	0.34	0.31	Average
10	4.822	29.18	56.00	-26.82	28.53	0.34	0.31	QP
11	7.175	11.68	50.00	-38.32	10.86	0.52	0.30	Average
12	7.175	28.69	60.00	-31.31	27.87	0.52	0.30	QP

Note 1: Level (dBuV) = Read Level (dBuV) + LISN Factor (dB) + Cable Loss (dB).  
 Note 2: Over Limit (dB) = Level (dBuV) – Limit Line (dBuV).

<b>Modulation Mode</b>	8DPSK	<b>Test Freq. (MHz)</b>	2402
<b>Power Phase</b>	Neutral	<b>Test Configuration</b>	2

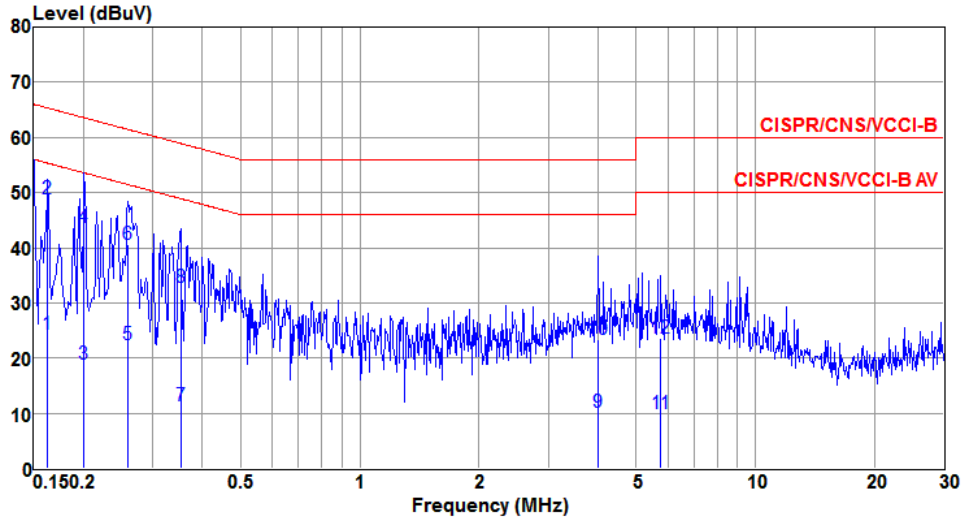

	Freq MHz	Level dBUV	Limit Line dBUV	Over Limit dB	Read Level dBUV	LISN factor dB	cable loss dB	Remark
1	0.162	24.30	55.34	-31.04	23.54	0.68	0.08	Average
2*	0.162	48.87	65.34	-16.47	48.11	0.68	0.08	QP
3	0.201	18.89	53.58	-34.69	18.56	0.24	0.09	Average
4	0.201	43.73	63.58	-19.85	43.40	0.24	0.09	QP
5	0.259	22.52	51.47	-28.95	22.22	0.20	0.10	Average
6	0.259	40.55	61.47	-20.92	40.25	0.20	0.10	QP
7	0.352	11.26	48.91	-37.65	11.00	0.15	0.11	Average
8	0.352	32.83	58.91	-26.08	32.57	0.15	0.11	QP
9	4.006	10.22	46.00	-35.78	9.17	0.74	0.31	Average
10	4.006	23.49	56.00	-32.51	22.44	0.74	0.31	QP
11	5.774	9.89	50.00	-40.11	8.93	0.65	0.31	Average
12	5.774	23.62	60.00	-36.38	22.66	0.65	0.31	QP

Note 1: Level (dBUV) = Read Level (dBUV) + LISN Factor (dB) + Cable Loss (dB).  
 2: Over Limit (dB) = Level (dBUV) – Limit Line (dBUV).

## 3.2 Unwanted Emissions into Restricted Frequency Bands

### 3.2.1 Limit of Unwanted Emissions into Restricted Frequency Bands

Restricted Band Emissions Limit			
Frequency Range (MHz)	Field Strength (uV/m)	Field Strength (dBuV/m)	Measure Distance (m)
0.009~0.490	2400/F(kHz)	48.5 - 13.8	300
0.490~1.705	24000/F(kHz)	33.8 - 23	30
1.705~30.0	30	29	30
30~88	100	40	3
88~216	150	43.5	3
216~960	200	46	3
Above 960	500	54	3

**Note 1:**  
 Qusai-Peak value is measured for frequency below 1GHz except for 9–90 kHz, 110–490 kHz frequency band. Peak and average value are measured for frequency above 1GHz. The limit on average radio frequency emission is as above table. The limit on peak radio frequency emissions is 20 dB above the maximum permitted average emission limit

**Note 2:**  
 Measurements may be performed at a distance other than what is specified provided. When performing measurements at a distance other than that specified, the results shall be extrapolated to the specified distance using an extrapolation factor as below, Frequency at or above 30 MHz: 20 dB/decade Frequency below 30 MHz: 40 dB/decade.

### 3.2.2 Test Procedures

1. Measurement is made at a semi-anechoic chamber that incorporates a turntable allowing a EUT rotation of 360°. A continuously-rotating, remotely-controlled turntable is installed at the test site to support the EUT and facilitate determination of the direction of maximum radiation for each EUT emission frequency. The EUT is placed at test table. For emissions testing at or below 1 GHz, the table height is 80 cm above the reference ground plane.
2. Measurement is made with the antenna positioned in both the horizontal and vertical planes of polarization. The measurement antenna is varied in height (1m ~ 4m) above the reference ground plane to obtain the maximum signal strength. Distance between EUT and antenna is 3 m.
3. This investigation is performed with the EUT rotated 360°, the antenna height scanned between 1 m and 4 m, and the antenna rotated to repeat the measurements for both the horizontal and vertical antenna polarizations.

Note:

1. 120kHz measurement bandwidth of test receiver and Quasi-peak detector is for radiated emission below 1GHz.

### 3.2.3 Test Setup

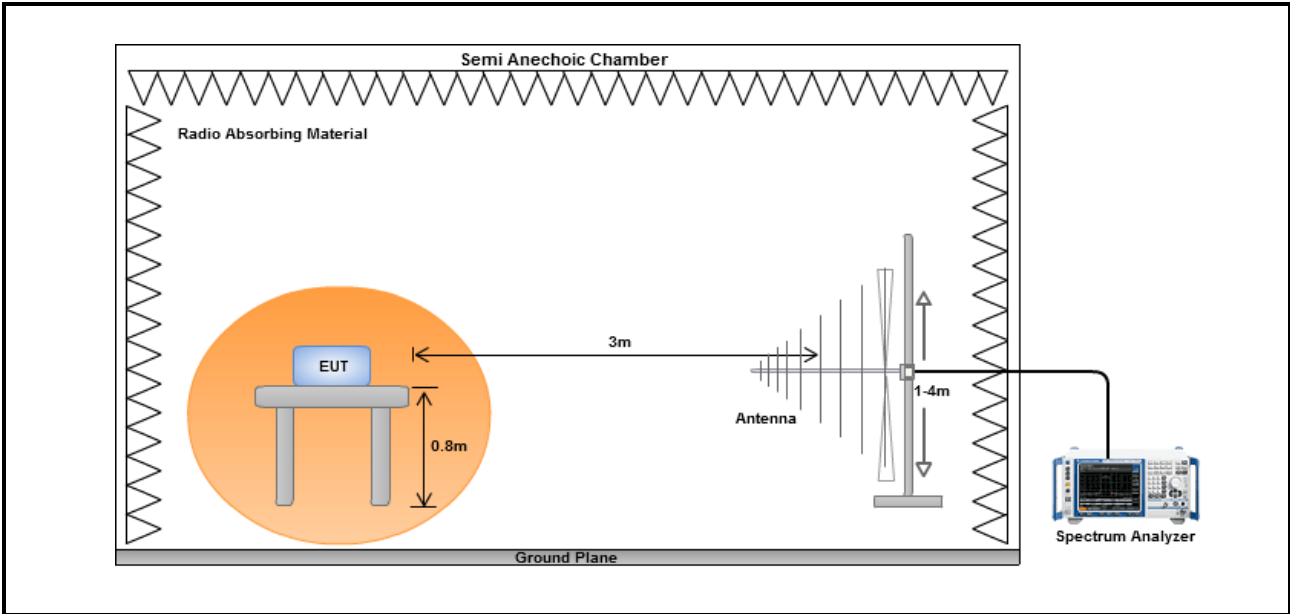

### 3.2.4 Transmitter Radiated Unwanted Emissions (Below 1GHz)

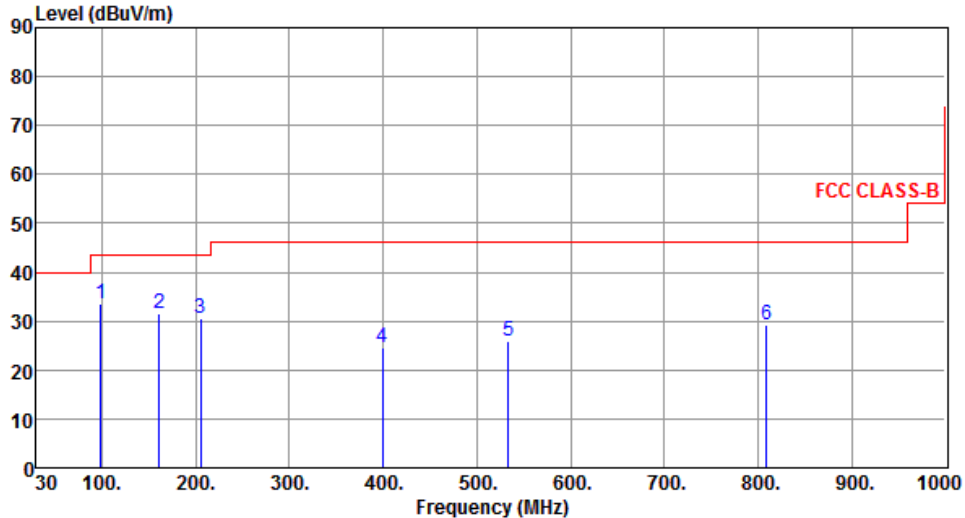
Modulation	8DPSK	Test Freq. (MHz)	2402																																																																								
Polarization	Horizontal	Test Configuration	1																																																																								
 <p>The graph plots Level (dBuV/m) on the y-axis (0 to 90) against Frequency (MHz) on the x-axis (30 to 1000). A red line represents the FCC CLASS-B limit, which is 40 dBuV/m from 30 to 100 MHz, 45 dBuV/m from 100 to 200 MHz, and 50 dBuV/m from 200 to 1000 MHz. Six blue vertical lines represent emission peaks labeled 1 through 6, with their respective frequencies and levels indicated in the table below.</p>																																																																											
	<table border="1"> <thead> <tr> <th>Freq.</th> <th>Emission level</th> <th>Limit</th> <th>Margin</th> <th>SA reading</th> <th>Factor</th> <th>Remark</th> <th>ANT High cm</th> <th>Turn Table deg</th> </tr> <tr> <th>MHz</th> <th>dBuV/m</th> <th>dBuV/m</th> <th>dB</th> <th>dBuV</th> <th>dB</th> <th></th> <th></th> <th></th> </tr> </thead> <tbody> <tr> <td>1</td> <td>33.45</td> <td>43.50</td> <td>-10.05</td> <td>55.52</td> <td>-22.07</td> <td>Peak</td> <td>---</td> <td>---</td> </tr> <tr> <td>2</td> <td>31.62</td> <td>43.50</td> <td>-11.88</td> <td>48.63</td> <td>-17.01</td> <td>Peak</td> <td>---</td> <td>---</td> </tr> <tr> <td>3</td> <td>30.63</td> <td>43.50</td> <td>-12.87</td> <td>50.18</td> <td>-19.55</td> <td>Peak</td> <td>---</td> <td>---</td> </tr> <tr> <td>4</td> <td>24.52</td> <td>46.00</td> <td>-21.48</td> <td>38.19</td> <td>-13.67</td> <td>Peak</td> <td>---</td> <td>---</td> </tr> <tr> <td>5</td> <td>25.82</td> <td>46.00</td> <td>-20.18</td> <td>36.83</td> <td>-11.01</td> <td>Peak</td> <td>---</td> <td>---</td> </tr> <tr> <td>6</td> <td>29.28</td> <td>46.00</td> <td>-16.72</td> <td>36.05</td> <td>-6.77</td> <td>Peak</td> <td>---</td> <td>---</td> </tr> </tbody> </table>	Freq.	Emission level	Limit	Margin	SA reading	Factor	Remark	ANT High cm	Turn Table deg	MHz	dBuV/m	dBuV/m	dB	dBuV	dB				1	33.45	43.50	-10.05	55.52	-22.07	Peak	---	---	2	31.62	43.50	-11.88	48.63	-17.01	Peak	---	---	3	30.63	43.50	-12.87	50.18	-19.55	Peak	---	---	4	24.52	46.00	-21.48	38.19	-13.67	Peak	---	---	5	25.82	46.00	-20.18	36.83	-11.01	Peak	---	---	6	29.28	46.00	-16.72	36.05	-6.77	Peak	---	---		
Freq.	Emission level	Limit	Margin	SA reading	Factor	Remark	ANT High cm	Turn Table deg																																																																			
MHz	dBuV/m	dBuV/m	dB	dBuV	dB																																																																						
1	33.45	43.50	-10.05	55.52	-22.07	Peak	---	---																																																																			
2	31.62	43.50	-11.88	48.63	-17.01	Peak	---	---																																																																			
3	30.63	43.50	-12.87	50.18	-19.55	Peak	---	---																																																																			
4	24.52	46.00	-21.48	38.19	-13.67	Peak	---	---																																																																			
5	25.82	46.00	-20.18	36.83	-11.01	Peak	---	---																																																																			
6	29.28	46.00	-16.72	36.05	-6.77	Peak	---	---																																																																			
<p>Note 1: Emission Level (dBuV/m) = SA Reading (dBuV/m) + Factor* (dB)            *Factor includes antenna factor , cable loss and amplifier gain            Note 2: Margin (dB) = Emission level (dBuV/m) – Limit (dBuV/m).            Note 3: All spurious emissions below 30MHz are more than 20 dB below the limit.</p>																																																																											



<b>Modulation</b>	8DPSK	<b>Test Freq. (MHz)</b>	2402
<b>Polarization</b>	Vertical	<b>Test Configuration</b>	1

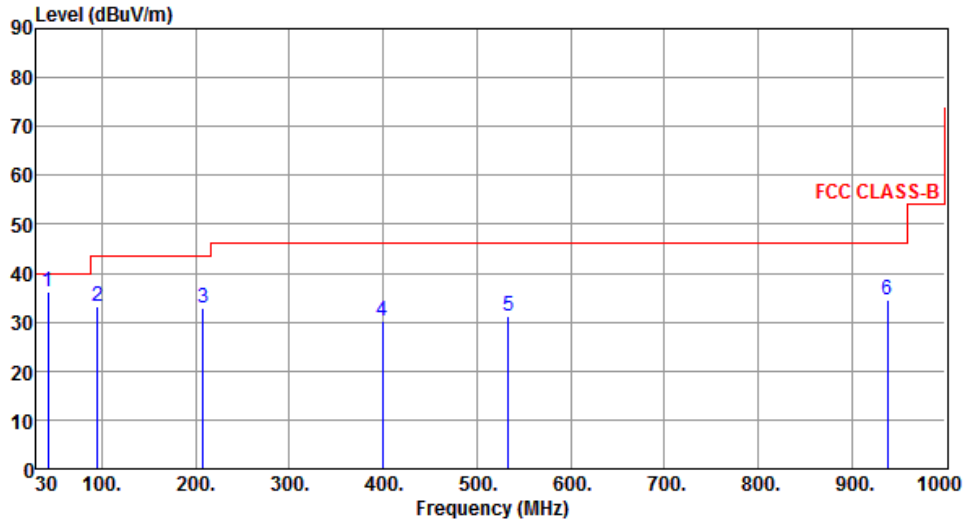

	Freq. MHz	Emission level dBuV/m	Limit dBuV/m	Margin dB	SA reading dBuV	Factor dB	Remark	ANT High cm	Turn Table deg
1	42.61	36.34	40.00	-3.66	53.33	-16.99	QP	---	---
2	94.99	33.17	43.50	-10.33	55.78	-22.61	Peak	---	---
3	207.51	32.88	43.50	-10.62	52.37	-19.49	Peak	---	---
4	399.57	30.19	46.00	-15.81	43.86	-13.67	Peak	---	---
5	533.43	31.32	46.00	-14.68	42.33	-11.01	Peak	---	---
6	937.92	34.38	46.00	-11.62	39.25	-4.87	Peak	---	---

Note 1: Emission Level (dBuV/m) = SA Reading (dBuV/m) + Factor\* (dB)

\*Factor includes antenna factor , cable loss and amplifier gain

Note 2: Margin (dB) = Emission level (dBuV/m) – Limit (dBuV/m).

Note 3: All spurious emissions below 30MHz are more than 20 dB below the limit.

<b>Modulation</b>	8DPSK	<b>Test Freq. (MHz)</b>	2402
<b>Polarization</b>	Horizontal	<b>Test Configuration</b>	2

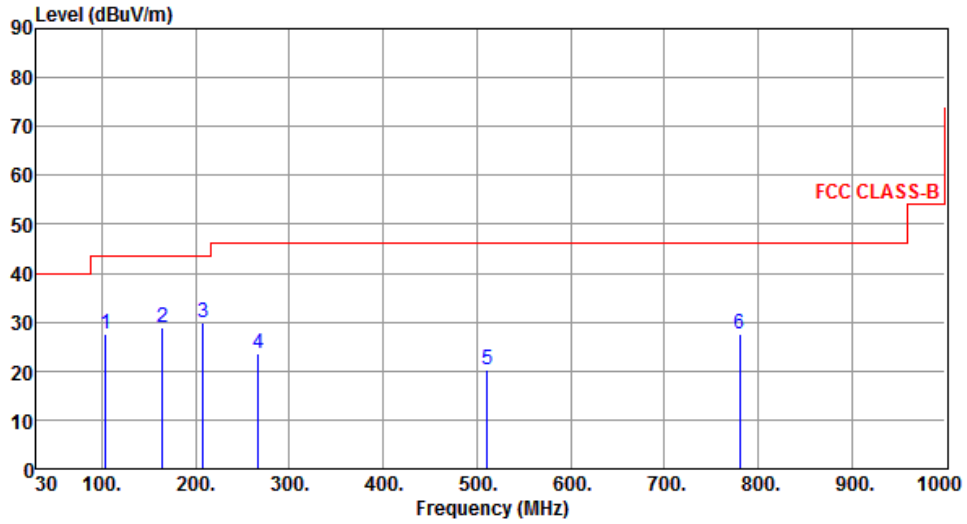

	Freq. MHz	Emission level dBuV/m	Limit dBuV/m	Margin dB	SA reading dBuV	Factor dB	Remark	ANT High cm	Turn Table deg
1	103.72	27.59	43.50	-15.91	48.97	-21.38	Peak	---	---
2	164.83	28.95	43.50	-14.55	46.17	-17.22	Peak	---	---
3	207.51	29.80	43.50	-13.70	49.29	-19.49	Peak	---	---
4	266.68	23.56	46.00	-22.44	40.86	-17.30	Peak	---	---
5	511.12	20.29	46.00	-25.71	31.77	-11.48	Peak	---	---
6	780.78	27.61	46.00	-18.39	34.68	-7.07	Peak	---	---

Note 1: Emission Level (dBuV/m) = SA Reading (dBuV/m) + Factor\* (dB)

\*Factor includes antenna factor , cable loss and amplifier gain

Note 2: Margin (dB) = Emission level (dBuV/m) – Limit (dBuV/m).

Note 3: All spurious emissions below 30MHz are more than 20 dB below the limit.

<b>Modulation</b>	8DPSK	<b>Test Freq. (MHz)</b>	2402
<b>Polarization</b>	Vertical	<b>Test Configuration</b>	2

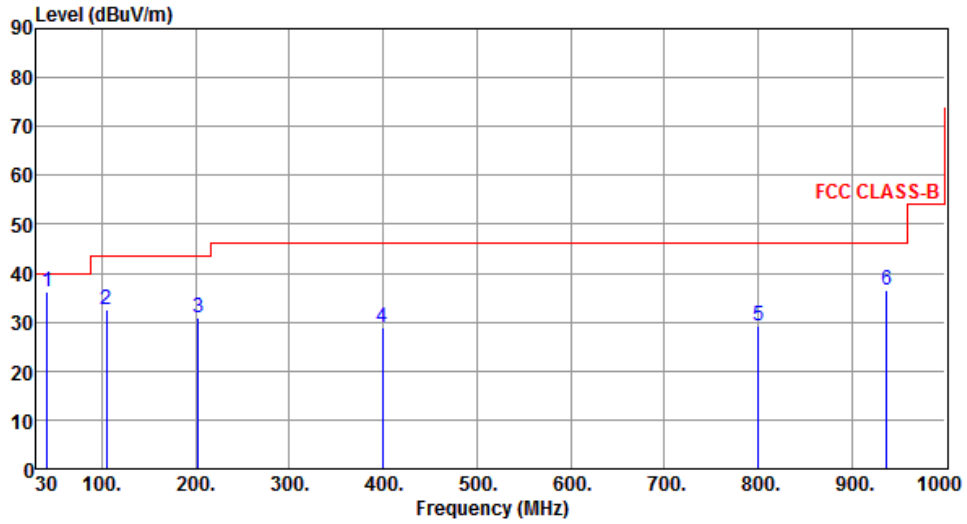

	Freq. MHz	Emission level dBuV/m	Limit dBuV/m	Margin dB	SA reading dBuV	Factor dB	Remark	ANT High cm	Turn Table deg
1	41.64	36.24	40.00	-3.76	53.32	-17.08	QP	---	---
2	104.69	32.48	43.50	-11.02	53.72	-21.24	Peak	---	---
3	202.66	30.90	43.50	-12.60	50.56	-19.66	Peak	---	---
4	399.57	28.84	46.00	-17.16	42.51	-13.67	Peak	---	---
5	800.18	29.10	46.00	-16.90	36.02	-6.92	Peak	---	---
6	936.95	36.64	46.00	-9.36	41.52	-4.88	Peak	---	---

Note 1: Emission Level (dBuV/m) = SA Reading (dBuV/m) + Factor\* (dB)

\*Factor includes antenna factor , cable loss and amplifier gain

Note 2: Margin (dB) = Emission level (dBuV/m) – Limit (dBuV/m).

Note 3: All spurious emissions below 30MHz are more than 20 dB below the limit.

<b>Modulation</b>	8DPSK	<b>Test Freq. (MHz)</b>	2402
<b>Polarization</b>	Horizontal	<b>Test Configuration</b>	3

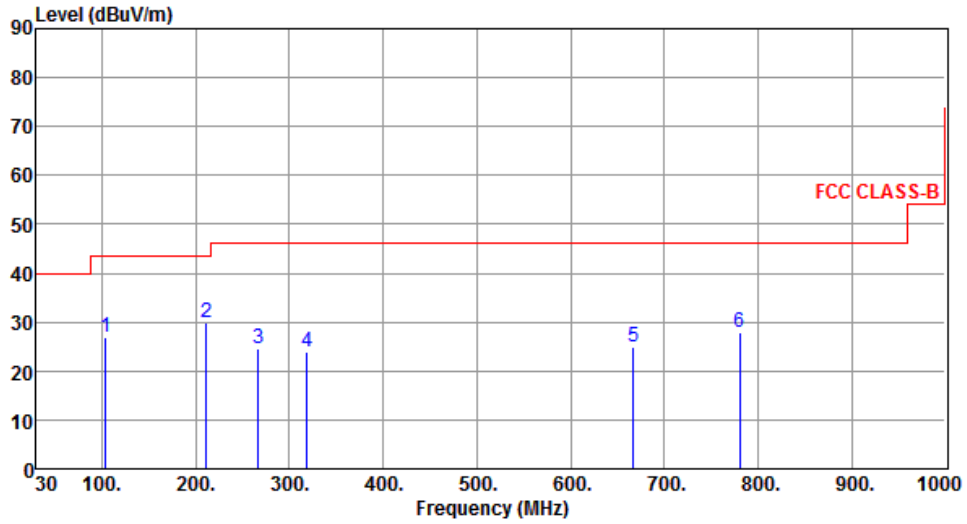

	Freq. MHz	Emission level dBuV/m	Limit dBuV/m	Margin dB	SA reading dBuV	Factor dB	Remark	ANT High cm	Turn Table deg
1	103.72	26.74	43.50	-16.76	48.12	-21.38	Peak	---	---
2	211.39	30.04	43.50	-13.46	49.44	-19.40	Peak	---	---
3	266.68	24.70	46.00	-21.30	42.00	-17.30	Peak	---	---
4	319.06	24.03	46.00	-21.97	39.69	-15.66	Peak	---	---
5	667.29	24.90	46.00	-21.10	33.66	-8.76	Peak	---	---
6	780.78	28.04	46.00	-17.96	35.11	-7.07	Peak	---	---

Note 1: Emission Level (dBuV/m) = SA Reading (dBuV/m) + Factor\* (dB)

\*Factor includes antenna factor , cable loss and amplifier gain

Note 2: Margin (dB) = Emission level (dBuV/m) – Limit (dBuV/m).

Note 3: All spurious emissions below 30MHz are more than 20 dB below the limit.

<b>Modulation</b>	8DPSK	<b>Test Freq. (MHz)</b>	2402
<b>Polarization</b>	Vertical	<b>Test Configuration</b>	3

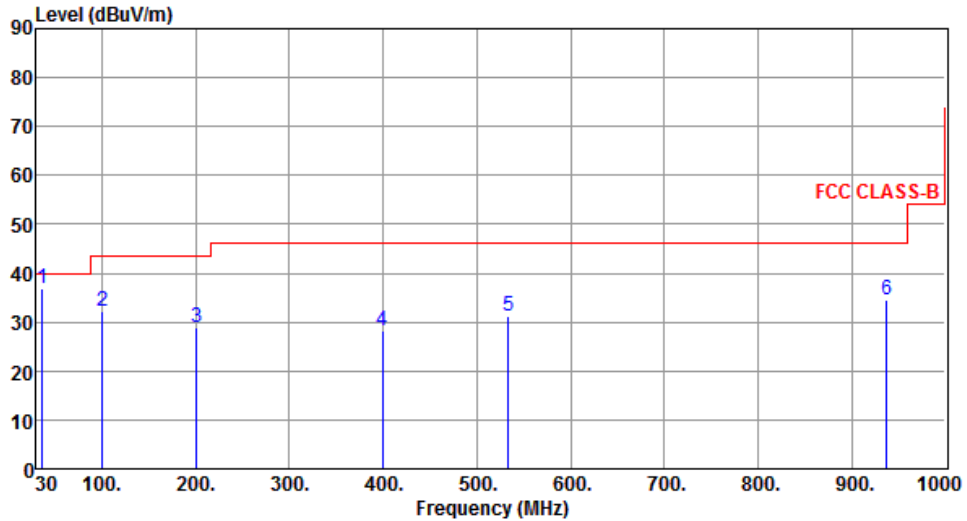

	Freq. MHz	Emission level dBuV/m	Limit dBuV/m	Margin dB	SA reading dBuV	Factor dB	Remark	ANT High cm	Turn Table deg
1	36.79	36.84	40.00	-3.16	54.34	-17.50	QP	---	---
2	100.81	32.29	43.50	-11.21	54.10	-21.81	Peak	---	---
3	200.72	28.77	43.50	-14.73	48.49	-19.72	Peak	---	---
4	399.57	28.31	46.00	-17.69	41.98	-13.67	Peak	---	---
5	533.43	31.26	46.00	-14.74	42.27	-11.01	Peak	---	---
6	936.95	34.48	46.00	-11.52	39.36	-4.88	Peak	---	---

Note 1: Emission Level (dBuV/m) = SA Reading (dBuV/m) + Factor\* (dB)

\*Factor includes antenna factor , cable loss and amplifier gain

Note 2: Margin (dB) = Emission level (dBuV/m) – Limit (dBuV/m).

Note 3: All spurious emissions below 30MHz are more than 20 dB below the limit.

## 4 Test laboratory information

Established in 2012, ICC provides foremost EMC & RF Testing and advisory consultation services by our skilled engineers and technicians. Our services employ a wide variety of advanced edge test equipment and one of the widest certification extents in the business.

International Certification Corp, it is our definitive objective is to institute long term, trust-based associations with our clients. The expectation we set up with our clients is based on outstanding service, practical expertise and devotion to a certified value structure. Our passion is to grant our clients with best EMC / RF services by oriented knowledgeable and accommodating staff.

Our Test sites are located at Linkou District and Kwei Shan Hsiang. Location map can be found on our website <http://www.icertifi.com.tw>.

### **Linkou**

Tel: 886-2-2601-1640

No. 30-2, Ding Fwu Tsuen, Lin Kou  
District, New Taipei City, Taiwan,  
R.O.C.

### **Kwei Shan**

Tel: 886-3-271-8666

No. 3-1, Lane 6, Wen San 3rd  
St., Kwei Shan Hsiang, Tao Yuan  
Hsien 333, Taiwan, R.O.C.

### **Kwei Shan Site II**

Tel: 886-3-271-8640

No. 14-1, Lane 19, Wen San 3rd  
St., Kwei Shan Hsiang, Tao Yuan  
Hsien 333, Taiwan, R.O.C.

If you have any suggestion, please feel free to contact us as below information

Tel: 886-3-271-8666

Fax: 886-3-318-0155

Email: ICC\_Service@icertifi.com.tw

==END==