

EMC Test Report
Application for Grant of Equipment Authorization
Industry Canada RSS-Gen Issue 3 / RSS 210 Issue 8
FCC Part 15, Subpart E

Model: SDC-MSD40NBT

IC CERTIFICATION #: 6616A-SDCMSD40NBT
FCC ID: TWG-SDCMSD40NBT

APPLICANT: Summit Data Communications
526 South Main St. Suite 805
Akron, OH 44311

TEST SITE(S): Elliott Laboratories
41039 Boyce Road.
Fremont, CA. 94538-2435

IC SITE REGISTRATION #: 2845B-4, 2845B-5, 2845B-7

REPORT DATE: February 29, 2012

FINAL TEST DATES: August 24, December 16, December 28, 2011
and January 3, 2012

TOTAL NUMBER OF PAGES: 85

PROGRAM MGR /
TECHNICAL REVIEWER:



Mark E Hill
Staff Engineer

QUALITY ASSURANCE DELEGATE /
FINAL REPORT PREPARER:



David Guidotti
Senior Technical Writer



Elliott Laboratories is accredited by the A2LA, certificate number 0214.26, to perform the test(s) listed in this report, except where noted otherwise. This report and the information contained herein represent the results of testing test articles identified and selected by the client performed to specifications and/or procedures selected by the client. National Technical Systems (NTS) makes no representations, expressed or implied, that such testing is adequate (or inadequate) to demonstrate efficiency, performance, reliability, or any other characteristic of the articles being tested, or similar products. This report should not be relied upon as an endorsement or certification by NTS of the equipment tested, nor does it represent any statement whatsoever as to its merchantability or fitness of the test article, or similar products, for a particular purpose. This report shall not be reproduced except in full

REVISION HISTORY

Rev#	Date	Comments	Modified By
-	2-29-2012	First release	

TABLE OF CONTENTS

REVISION HISTORY	2
TABLE OF CONTENTS	3
SCOPE.....	4
OBJECTIVE	5
STATEMENT OF COMPLIANCE.....	5
DEVIATIONS FROM THE STANDARDS.....	5
TEST RESULTS SUMMARY	6
UNII / LELAN DEVICES	6
GENERAL REQUIREMENTS APPLICABLE TO ALL BANDS.....	9
MEASUREMENT UNCERTAINTIES.....	10
EQUIPMENT UNDER TEST (EUT) DETAILS.....	11
GENERAL.....	11
OTHER EUT DETAILS.....	11
ANTENNA SYSTEM	11
ENCLOSURE.....	11
MODIFICATIONS.....	11
SUPPORT EQUIPMENT	12
EUT INTERFACE PORTS	12
EUT OPERATION	12
TEST SITE.....	13
GENERAL INFORMATION.....	13
CONDUCTED EMISSIONS CONSIDERATIONS	13
RADIATED EMISSIONS CONSIDERATIONS	13
MEASUREMENT INSTRUMENTATION	14
RECEIVER SYSTEM	14
INSTRUMENT CONTROL COMPUTER	14
LINE IMPEDANCE STABILIZATION NETWORK (LISN).....	14
FILTERS/ATTENUATORS	15
ANTENNAS.....	15
ANTENNA MAST AND EQUIPMENT TURNTABLE.....	15
INSTRUMENT CALIBRATION.....	15
TEST PROCEDURES	16
EUT AND CABLE PLACEMENT	16
CONDUCTED EMISSIONS.....	16
RADIATED EMISSIONS.....	17
CONDUCTED EMISSIONS FROM ANTENNA PORT	19
BANDWIDTH MEASUREMENTS	19
SPECIFICATION LIMITS AND SAMPLE CALCULATIONS	20
CONDUCTED EMISSIONS SPECIFICATION LIMITS: FCC 15.207; FCC 15.107(A), RSS GEN	20
GENERAL TRANSMITTER RADIATED EMISSIONS SPECIFICATION LIMITS	21
RECEIVER RADIATED SPURIOUS EMISSIONS SPECIFICATION LIMITS	21
OUTPUT POWER LIMITS – FHSS SYSTEMS	22
TRANSMIT MODE SPURIOUS RADIATED EMISSIONS LIMITS – FHSS AND DTS SYSTEMS.....	22
FCC 15.407 (A) OUTPUT POWER LIMITS	22
OUTPUT POWER LIMITS –LELAN DEVICES.....	23
SPURIOUS EMISSIONS LIMITS –UNII AND LELAN DEVICES	23
SAMPLE CALCULATIONS - CONDUCTED EMISSIONS	23
SAMPLE CALCULATIONS - RADIATED EMISSIONS.....	24
SAMPLE CALCULATIONS - FIELD STRENGTH TO EIRP CONVERSION.....	25
APPENDIX A TEST EQUIPMENT CALIBRATION DATA	26
APPENDIX B TEST DATA	27
END OF REPORT	85

SCOPE

An electromagnetic emissions test has been performed on the Summit Data Communications model SDC-MSD40NBT, pursuant to the following rules:

Industry Canada RSS-Gen Issue 3
RSS 210 Issue 8 "Low-power Licence-exempt Radiocommunication Devices (All Frequency Bands): Category I Equipment"
FCC Part 15, Subpart E requirements for UNII Devices (using FCC DA 02-2138, August 30, 2002)

Conducted and radiated emissions data has been collected, reduced, and analyzed within this report in accordance with measurement guidelines set forth in the following reference standards and as outlined in Elliott Laboratories test procedures:

ANSI C63.4:2003
FCC UNII test procedure KDB 789033 D01, Dated 10/25/2011

The intentional radiator above has been tested in a simulated typical installation to demonstrate compliance with the relevant Industry Canada performance and procedural standards.

Final system data was gathered in a mode that tended to maximize emissions by varying orientation of EUT, orientation of power and I/O cabling, antenna search height, and antenna polarization.

Every practical effort was made to perform an impartial test using appropriate test equipment of known calibration. All pertinent factors have been applied to reach the determination of compliance.

OBJECTIVE

The primary objective of the manufacturer is compliance with the regulations outlined in the previous section.

Prior to marketing in the USA, all unlicensed transmitters and transceivers require certification. Receive-only devices operating between 30 MHz and 960 MHz are subject to either certification or a manufacturer's declaration of conformity, with all other receive-only devices exempt from the technical requirements.

Prior to marketing in Canada, Class I transmitters, receivers and transceivers require certification. Class II devices are required to meet the appropriate technical requirements but are exempt from certification requirements.

Certification is a procedure where the manufacturer submits test data and technical information to a certification body and receives a certificate or grant of equipment authorization upon successful completion of the certification body's review of the submitted documents. Once the equipment authorization has been obtained, the label indicating compliance must be attached to all identical units, which are subsequently manufactured.

Maintenance of compliance is the responsibility of the manufacturer. Any modification of the product which may result in increased emissions should be checked to ensure compliance has been maintained (i.e., printed circuit board layout changes, different line filter, different power supply, harnessing or I/O cable changes, etc.).

STATEMENT OF COMPLIANCE

The tested sample of Summit Data Communications model SDC-MSD40NBT complied with the requirements of the following regulations:

- Industry Canada RSS-Gen Issue 3
- RSS 210 Issue 8 "Low-power Licence-exempt Radiocommunication Devices (All Frequency Bands): Category I Equipment"
- FCC Part 15, Subpart E requirements for UNII Devices

Maintenance of compliance is the responsibility of the manufacturer. Any modifications to the product should be assessed to determine their potential impact on the compliance status of the device with respect to the standards detailed in this test report.

The test results recorded herein are based on a single type test of Summit Data Communications model SDC-MSD40NBT and therefore apply only to the tested sample. The sample was selected and prepared by Ron Seide of Summit Data Communications.

DEVIATIONS FROM THE STANDARDS

No deviations were made from the published requirements listed in the scope of this report.

TEST RESULTS SUMMARY**UNII / LELAN DEVICES****Operation in the 5.15 – 5.25 GHz Band**

FCC Rule Part	RSS Rule Part	Description	Measured Value / Comments	Limit / Requirement	Result
15.407(e)		Indoor operation only	Refer to user's manual	N/A	Complies
15.407(a)(2)		26dB Bandwidth	26.3MHz	N/A – limits output power if < 20MHz	N/A
15.407 (a)(1)	A9.2(1)	Output Power	802.11a: 10.8dBm (0.012W) n20: 9.7dBm (0.009W) (Max eirp: 0.038W)	17dBm	Complies
15.407 (a)(1)	-	Power Spectral Density	802.11a: 0.3dBm/MHz	4 dBm/MHz	Complies
-	A9.5 (2)			5 dBm/MHz	Complies

Operation in the 5.25 – 5.35 GHz Band

FCC Rule Part	RSS Rule Part	Description	Measured Value / Comments	Limit / Requirement	Result (margin)
15.407(a)(2)		26dB Bandwidth	22.2MHz	N/A – limits output power if < 20MHz	N/A
15.407(a)(2)	A9.2(2)	Output Power	802.11a: 14.2dBm (0.026W) n20: 13.2dBm (0.021W) (Max eirp: 0.082)	17dBm (50mW)	Complies
15.407(a)(2)	-	Power Spectral Density	802.11a: 3.1dBm/MHz	11 dBm/MHz	Complies
-	A9.2(2) / A9.5 (2)	Power Spectral Density	802.11n20: 1.7dBm/MHz	11 dBm/MHz	Complies

Operation in the 5.47 – 5.725 GHz Band

FCC Rule Part	RSS Rule Part	Description	Measured Value / Comments	Limit / Requirement	Result (margin)
15.407(a) (2)		26dB Bandwidth	22.3MHz	N/A – limits output power if < 20MHz	N/A
15.407(a) (2)	A9.2(2)	Output Power	802.11a: 15.0dBm (0.031W) 802.11n20: 13.2dBm (0.021W) (Max eirp: 0.099W)	24 dBm / 250mW (eirp < 30dBm)	Complies
15.407(a) (2)		Power Spectral Density	802.11a: 4.0 dBm/MHz	11 dBm/MHz	Complies
	A9.2(2) / A9.5 (2)	Power Spectral Density	802.11n20: 2.1dBm/MHz	11 dBm/MHz	Complies
KDB 443999	A9	Non-operation in 5600 – 5650 MHz sub band	Device cannot operate in the 5600 – 5650 MHz band –refer to Operational Description		Complies

Requirements for all U-NII/LELAN bands

FCC Rule Part	RSS Rule Part	Description	Measured Value / Comments	Limit / Requirement	Result
15.407	A9.5a	Modulation	Digital Modulation is used	Digital modulation is required	Complies
15.407(b)(5) / 15.209	A9.3	Spurious Emissions	47.6dB μ V/m @ 5458.7MHz (-6.4dB)	Refer to page 23	Complies
15.407(a)(6)	-	Peak Excursion Ratio	12.1dB	< 13dB	Complies
	A9.5 (3)	Channel Selection	Spurious emissions tested at outermost channels in each band	Device was tested on the top, bottom and center channels in each band	N/A
15			Measurements on three channels in each band		Complies
15.407 (c)	A9.5(4)	Operation in the absence of information to transmit	Operation is discontinued in the absence of information	Device shall automatically discontinue operation in the absence of information to transmit	Complies
15.407 (g)	A9.5 (5)	Frequency Stability	Frequency stability is better than 10ppm	Signal shall remain within the allocated band	Complies
15.407 (h1)	A9.4	Transmit Power Control	TPC is not required as the device operates at below 500mW eirp	The U-NII device shall have the capability to operate with a mean EIRP value lower than 24dBm (250mW)	Complies
15.407 (h2)	A9.4	Dynamic frequency Selection (device without radar detection)	Refer to separate test report, reference R86484	Channel move time < 10s Channel closing transmission time < 260ms	Complies
	A9.9g	User Manual information	Refer to Exhibit 6 for details	Warning regarding interference from Satellite Systems	Complies

GENERAL REQUIREMENTS APPLICABLE TO ALL BANDS

FCC Rule Part	RSS Rule part	Description	Measured Value / Comments	Limit / Requirement	Result (margin)
15.203	-	RF Connector	EUT uses u.FL connectors	Unique or integral antenna required	Complies
15.207	RSS GEN Table 2	AC Conducted Emissions	31.9dB μ V @ 19.501MHz (-18.1dB)	Refer to page 20	Complies
15.109	RSS GEN 7.2.3 Table 1	Receiver spurious emissions	51.8dB μ V/m @ 2994.7MHz (-2.2dB)	Refer to page 21	Complies
15.247 (b) (5) 15.407 (f)	RSS 102	RF Exposure Requirements	Refer to MPE calculations in Exhibit 11, RSS 102 declaration and User Manual statements.	Refer to OET 65, FCC Part 1 and RSS 102	Complies
-	RSP 100 RSS GEN 7.1.5	User Manual		Statement required regarding non-interference	Complies
-	RSP 100 RSS GEN 7.1.5	User Manual		Statement for products with detachable antenna	Complies
-	RSP 100 RSS GEN 4.4.1	99% Bandwidth	802.11a: 17.3MHz 802.11n20: 18.1MHz	Information only	N/A

MEASUREMENT UNCERTAINTIES

ISO/IEC 17025 requires that an estimate of the measurement uncertainties associated with the emissions test results be included in the report. The measurement uncertainties given below are based on a 95% confidence level and were calculated in accordance with UKAS document LAB 34.

Measurement Type	Measurement Unit	Frequency Range	Expanded Uncertainty
RF power, conducted (power meter)	dBm	25 to 7000 MHz	± 0.52 dB
RF power, conducted (Spectrum analyzer)	dBm	25 to 7000 MHz	± 0.7 dB
Conducted emission of transmitter	dBm	25 to 26500 MHz	± 0.7 dB
Conducted emission of receiver	dBm	25 to 26500 MHz	± 0.7 dB
Radiated emission (substitution method)	dBm	25 to 26500 MHz	± 2.5 dB
Radiated emission (field strength)	dB μ V/m	25 to 1000 MHz	± 3.6 dB
		1000 to 40000 MHz	± 6.0 dB
Conducted Emissions (AC Power)	dB μ V	0.15 to 30 MHz	± 2.4 dB

EQUIPMENT UNDER TEST (EUT) DETAILS**GENERAL**

The Summit Data Communications model SDC-MSD40NBT is an 802.11abgn 1x1 with Bluetooth 2.1 module.

The sample was received on October 19, 2010 and tested on August 24, December 16, December 28, 2011 and January 3, 2012. The EUT consisted of the following component(s):

Company	Model	Description	Serial Number	FCC ID
Summit	SDC-MSD40NBT	802.11abgn 1x with BT	Prototype	TWG-SDCMSD40NBT

OTHER EUT DETAILS

The EUT supports single transmit chain operation. The EUT supports 20MHz operation only.

ANTENNA SYSTEM

Dipole Antenna #1 - 2.4 and 5GHz bands - Larsen, R380.500.314, 1.6dBi (2.4GHz), 5dBi (5GHz)

Dipole Antenna #2 - 2.4 GHz only - Cisco Air-Ant 4941 2dBi(2.4GHz)

In the 2.4GHz range, the Cisco antenna was tested as they represented the highest gain antennas of each available type.

In the 5GHz range, Larsen antenna was tested as the represented the highest gain antennas of each available type.

The antenna connects to the EUT via a non-standard u.FL antenna connector, thereby meeting the requirements of FCC 15.203.

ENCLOSURE

The EUT has no enclosure. It is designed to be installed within the enclosure of a host computer.

MODIFICATIONS

No modifications were made to the EUT during the time the product was at Elliott.

SUPPORT EQUIPMENT

The following equipment was used as support equipment for testing:

Company	Model	Description	Serial Number	FCC ID
Delta Electronics	EADP-10BB	AC/DC Adapter	59A401Z9UP42 K	N/A
HP	iPaQ	PDA	2CK702010G	N/A
Lenovo	Inspiron 1545	Laptop Computer (Note 1)	953R2K1	DoC

Note 1 – Used to configure the BT radio and then disconnected

EUT INTERFACE PORTS

The I/O cabling configuration during testing was as follows:

Port	Connected To	Description	Cable(s)	
			Shielded or Unshielded	Length(m)
AC/DC Adapter	iPaq	2wire	Unshielded	1.5m
AC/DC Adapter	AC Mains	-	-	-

EUT OPERATION

During testing, the EUT was configured to transmit continuously at the lowest data rate for the mode as this resulted in the highest output power.

TEST SITE**GENERAL INFORMATION**

Final test measurements were taken at the test sites listed below. Pursuant to section 2.948 of the FCC's Rules and section 3.3 of RSP-100, construction, calibration, and equipment data has been filed with the Commission and with industry Canada.

Site	Registration Numbers		Location
	FCC	Canada	
Chamber 4	211948	2845B-4	41039 Boyce Road Fremont, CA 94538-2435
Chamber 5	211948	2845B-5	
Chamber 7	A2LA accreditation	2845B-7	

ANSI C63.4:2003 recommends that ambient noise at the test site be at least 6 dB below the allowable limits. Ambient levels are below this requirement. The test site(s) contain separate areas for radiated and conducted emissions testing. Considerable engineering effort has been expended to ensure that the facilities conform to all pertinent requirements of ANSI C63.4:2003.

CONDUCTED EMISSIONS CONSIDERATIONS

Conducted emissions testing is performed in conformance with ANSI C63.4:2003. Measurements are made with the EUT connected to the public power network through a nominal, standardized RF impedance, which is provided by a line impedance stabilization network, known as a LISN. A LISN is inserted in series with each current-carrying conductor in the EUT power cord.

RADIATED EMISSIONS CONSIDERATIONS

The FCC has determined that radiation measurements made in a shielded enclosure are not suitable for determining levels of radiated emissions. Radiated measurements are performed in an open field environment or in a semi-anechoic chamber. The test sites are maintained free of conductive objects within the CISPR defined elliptical area incorporated in ANSI C63.4:2003 guidelines and meet the Normalized Site Attenuation (NSA) requirements of ANSI C63.4:2003.

MEASUREMENT INSTRUMENTATION

RECEIVER SYSTEM

An EMI receiver as specified in CISPR 16-1-1 is used for emissions measurements. The receivers used can measure over the frequency range of 9 kHz up to 2000 MHz. These receivers allow both ease of measurement and high accuracy to be achieved. The receivers have Peak, Average, and CISPR (Quasi-peak) detectors built into their design so no external adapters are necessary. The receiver automatically sets the required bandwidth for the CISPR detector used during measurements. If the repetition frequency of the signal being measured is below 20Hz, peak measurements are made in lieu of Quasi-Peak measurements.

For measurements above the frequency range of the receivers, a spectrum analyzer is utilized because it provides visibility of the entire spectrum along with the precision and versatility required to support engineering analysis. Average measurements above 1000MHz are performed on the spectrum analyzer using the linear-average method with a resolution bandwidth of 1 MHz and a video bandwidth of 10 Hz, unless the signal is pulsed in which case the average (or video) bandwidth of the measuring instrument is reduced to onset of pulse desensitization and then increased.

INSTRUMENT CONTROL COMPUTER

The receivers utilize either a Rohde & Schwarz EZM Spectrum Monitor/Controller or contain an internal Spectrum Monitor/Controller to view and convert the receiver measurements to the field strength at an antenna or voltage developed at the LISN measurement port, which is then compared directly with the appropriate specification limit. This provides faster, more accurate readings by performing the conversions described under Sample Calculations within the Test Procedures section of this report. Results are printed in a graphic and/or tabular format, as appropriate. A personal computer is used to record all measurements made with the receivers.

The Spectrum Monitor provides a visual display of the signal being measured. In addition, the controller or a personal computer run automated data collection programs which control the receivers. This provides added accuracy since all site correction factors, such as cable loss and antenna factors are added automatically.

LINE IMPEDANCE STABILIZATION NETWORK (LISN)

Line conducted measurements utilize a fifty microhenry Line Impedance Stabilization Network as the monitoring point. The LISN used also contains a 250 uH CISPR adapter. This network provides for calibrated radio frequency noise measurements by the design of the internal low pass and high pass filters on the EUT and measurement ports, respectively.

FILTERS/ATTENUATORS

External filters and precision attenuators are often connected between the receiving antenna or LISN and the receiver. This eliminates saturation effects and non-linear operation due to high amplitude transient events.

ANTENNAS

A loop antenna is used below 30 MHz. For the measurement range 30 MHz to 1000 MHz either a combination of a biconical antenna and a log periodic or a bi-log antenna is used. Above 1000 MHz, horn antennas are used. The antenna calibration factors to convert the received voltage to an electric field strength are included with appropriate cable loss and amplifier gain factors to determine an overall site factor, which is then programmed into the test receivers or incorporated into the test software.

ANTENNA MAST AND EQUIPMENT TURNTABLE

The antennas used to measure the radiated electric field strength are mounted on a non-conductive antenna mast equipped with a motor-drive to vary the antenna height. Measurements below 30 MHz are made with the loop antenna at a fixed height of 1m above the ground plane.

ANSI C63.4:2003 specifies that the test height above ground for table mounted devices shall be 80 centimeters. Floor mounted equipment shall be placed on the ground plane if the device is normally used on a conductive floor or separated from the ground plane by insulating material from 3 to 12 mm if the device is normally used on a non-conductive floor. During radiated measurements, the EUT is positioned on a motorized turntable in conformance with this requirement.

INSTRUMENT CALIBRATION

All test equipment is regularly checked to ensure that performance is maintained in accordance with the manufacturer's specifications. All antennas are calibrated at regular intervals with respect to tuned half-wave dipoles. An exhibit of this report contains the list of test equipment used and calibration information.

TEST PROCEDURES

EUT AND CABLE PLACEMENT

The regulations require that interconnecting cables be connected to the available ports of the unit and that the placement of the unit and the attached cables simulate the worst case orientation that can be expected from a typical installation, so far as practicable. To this end, the position of the unit and associated cabling is varied within the guidelines of ANSI C63.4:2003, and the worst-case orientation is used for final measurements.

CONDUCTED EMISSIONS

Conducted emissions are measured at the plug end of the power cord supplied with the EUT. Excess power cord length is wrapped in a bundle between 30 and 40 centimeters in length near the center of the cord. Preliminary measurements are made to determine the highest amplitude emission relative to the specification limit for all the modes of operation. Placement of system components and varying of cable positions are performed in each mode. A final peak mode scan is then performed in the position and mode for which the highest emission was noted on all current carrying conductors of the power cord.

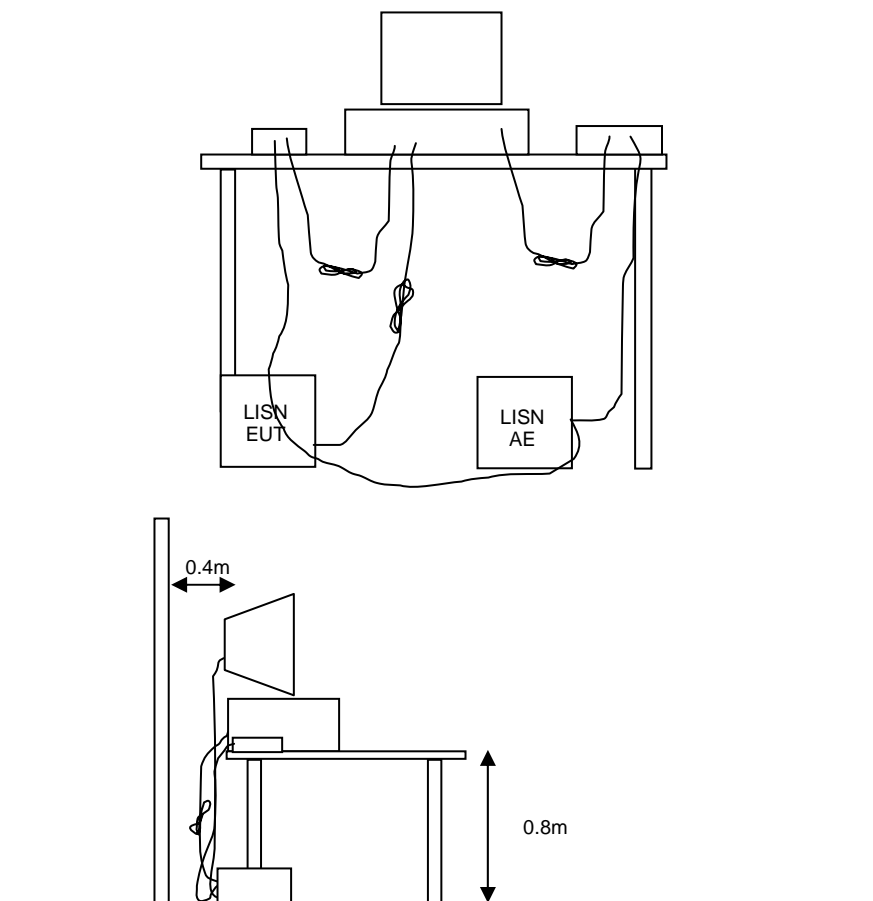

Figure 1 Typical Conducted Emissions Test Configuration

RADIATED EMISSIONS

A preliminary scan of the radiated emissions is performed in which all significant EUT frequencies are identified with the system in a nominal configuration. At least two scans are performed, one scan for each antenna polarization (horizontal and vertical; loop parallel and perpendicular to the EUT). During the preliminary scans, the EUT is rotated through 360°, the antenna height is varied (for measurements above 30 MHz) and cable positions are varied to determine the highest emission relative to the limit. Preliminary scans may be performed in a fully anechoic chamber for the purposes of identifying the frequencies of the highest emissions from the EUT.

A speaker is provided in the receiver to aid in discriminating between EUT and ambient emissions. Other methods used during the preliminary scan for EUT emissions involve scanning with near field magnetic loops, monitoring I/O cables with RF current clamps, and cycling power to the EUT.

Final maximization is a phase in which the highest amplitude emissions identified in the spectral search are viewed while the EUT azimuth angle is varied from 0 to 360 degrees relative to the receiving antenna. The azimuth, which results in the highest emission is then maintained while varying the antenna height from one to four meters (for measurements above 30 MHz, measurements below 30 MHz are made with the loop antenna at a fixed height of 1m). The result is the identification of the highest amplitude for each of the highest peaks. Each recorded level is corrected in the receiver using appropriate factors for cables, connectors, antennas, and preamplifier gain.

When testing above 18 GHz, the receive antenna is located at 1 meter from the EUT and the antenna height is restricted to a maximum of 2.5 meters.

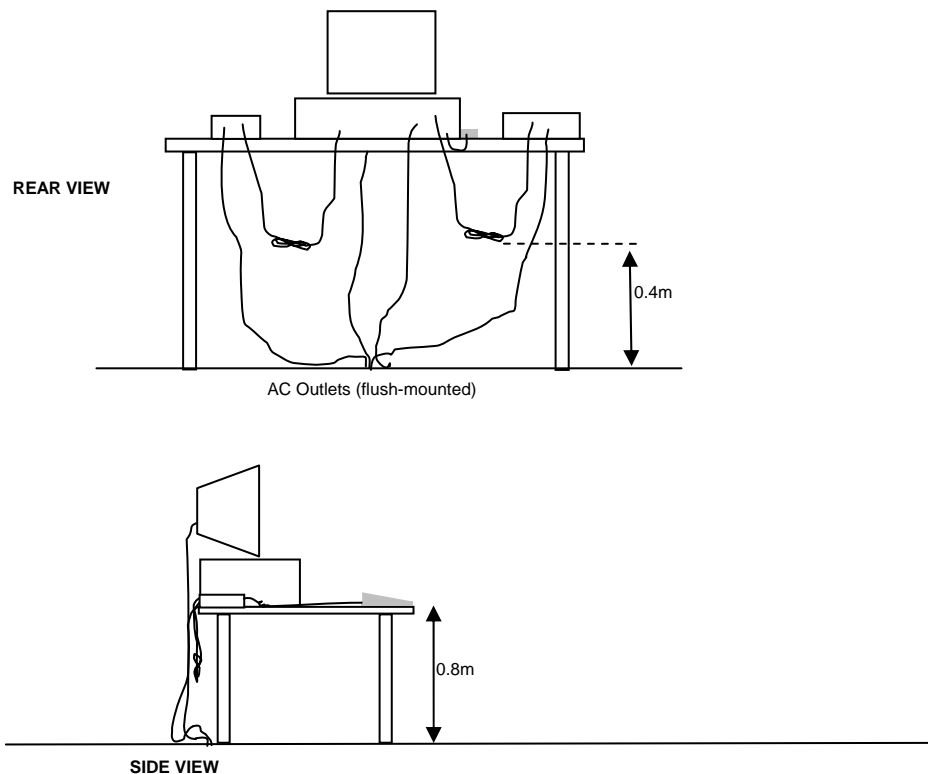

Typical Test Configuration for Radiated Field Strength Measurements

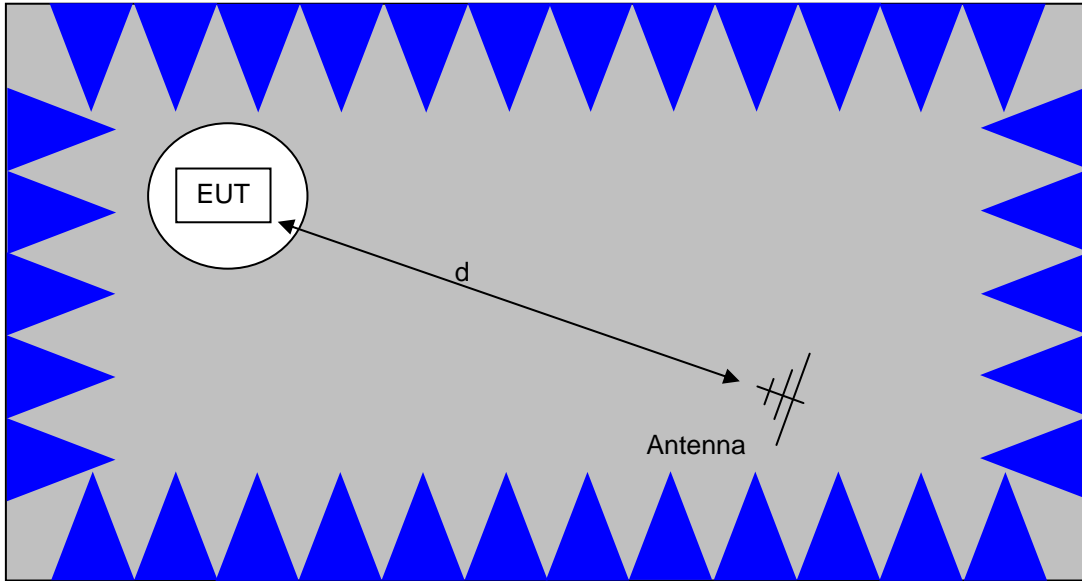

The anechoic materials on the walls and ceiling ensure compliance with the normalized site attenuation requirements of CISPR 16 / CISPR 22 / ANSI C63.4 for an alternate test site at the measurement distances used.

Floor-standing equipment is placed on the floor with insulating supports between the unit and the ground plane.

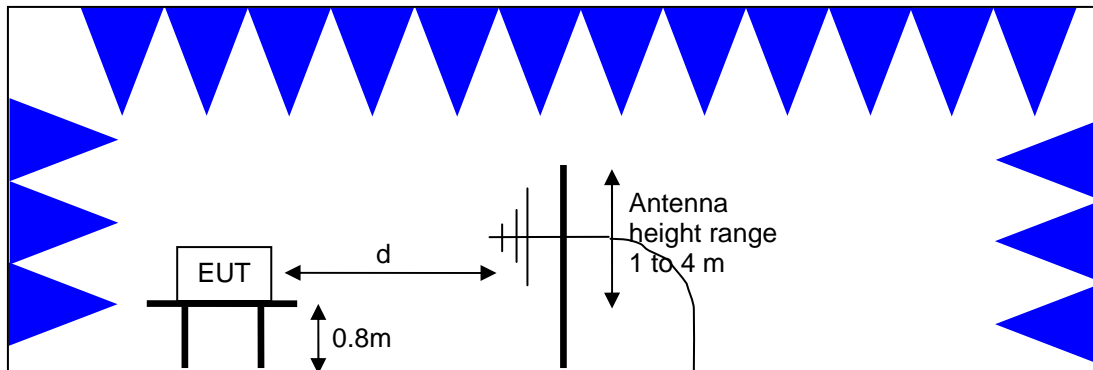

Test Configuration for Radiated Field Strength Measurements
Semi-Anechoic Chamber, Plan and Side Views

CONDUCTED EMISSIONS FROM ANTENNA PORT

Direct measurements of power, bandwidth and power spectral density are performed, where possible, with the antenna port of the EUT connected to either the power meter or spectrum analyzer via a suitable attenuator and/or filter. These are used to ensure that the front end of the measurement instrument is not overloaded by the fundamental transmission.

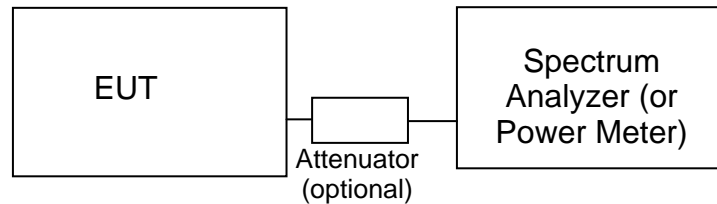
**Test Configuration for Antenna Port Measurements**

Measurement bandwidths (video and resolution) are set in accordance with the relevant standards and Elliott's test procedures for the type of radio being tested. When power measurements are made using a resolution bandwidth less than the signal bandwidth the power is calculated by summing the power across the signal bandwidth using either the analyzer channel power function or by capturing the trace data and calculating the power using software. In both cases the summed power is corrected to account for the equivalent noise bandwidth (ENBW) of the resolution bandwidth used.

If power averaging is used (typically for certain digital modulation techniques), the EUT is configured to transmit continuously. Power averaging is performed using either the built-in function of the analyzer or, if the analyzer does not feature power averaging, using external software. In both cases the average power is calculated over a number of sweeps (typically 100). When the EUT cannot be configured to continuously transmit then either the analyzer is configured to perform a gated sweep to ensure that the power is averaged over periods that the device is transmitting or power averaging is disabled and a max-hold feature is used.

If a power meter is used to make output power measurements the sensor head type (peak or average) is stated in the test data table.

BANDWIDTH MEASUREMENTS

The 6dB, 20dB and/or 26dB signal bandwidth is measured in using the bandwidths recommended by ANSI C63.4. When required, the 99% bandwidth is measured using the methods detailed in RSS GEN.

SPECIFICATION LIMITS AND SAMPLE CALCULATIONS

The limits for conducted emissions are given in units of microvolts, and the limits for radiated emissions are given in units of microvolts per meter at a specified test distance. Data is measured in the logarithmic form of decibels relative to one microvolt, or dB microvolts (dBuV). For radiated emissions, the measured data is converted to the field strength at the antenna in dB microvolts per meter (dBuV/m). The results are then converted to the linear forms of uV and uV/m for comparison to published specifications.

For reference, converting the specification limits from linear to decibel form is accomplished by taking the base ten logarithm, then multiplying by 20. These limits in both linear and logarithmic form are as follows:

CONDUCTED EMISSIONS SPECIFICATION LIMITS: FCC 15.207; FCC 15.107(a), RSS GEN

The table below shows the limits for the emissions on the AC power line from an intentional radiator and a receiver.

Frequency (MHz)	Average Limit (dBuV)	Quasi Peak Limit (dBuV)
0.150 to 0.500	Linear decrease on logarithmic frequency axis between 56.0 and 46.0	Linear decrease on logarithmic frequency axis between 66.0 and 56.0
0.500 to 5.000	46.0	56.0
5.000 to 30.000	50.0	60.0

GENERAL TRANSMITTER RADIATED EMISSIONS SPECIFICATION LIMITS

The table below shows the limits for the spurious emissions from transmitters that fall in restricted bands¹ (with the exception of transmitters operating under FCC Part 15 Subpart D and RSS 210 Annex 9), the limits for all emissions from a low power device operating under the general rules of RSS 310 (tables 3 and 4), RSS 210 (table 2) and FCC Part 15 Subpart C section 15.209.

Frequency Range (MHz)	Limit (uV/m)	Limit (dBuV/m @ 3m)
0.009-0.490	2400/F _{KHz} @ 300m	67.6-20*log ₁₀ (F _{KHz}) @ 300m
0.490-1.705	24000/F _{KHz} @ 30m	87.6-20*log ₁₀ (F _{KHz}) @ 30m
1.705 to 30	30 @ 30m	29.5 @ 30m
30 to 88	100 @ 3m	40 @ 3m
88 to 216	150 @ 3m	43.5 @ 3m
216 to 960	200 @ 3m	46.0 @ 3m
Above 960	500 @ 3m	54.0 @ 3m

RECEIVER RADIATED SPURIOUS EMISSIONS SPECIFICATION LIMITS

The table below shows the limits for the spurious emissions from receivers as detailed in FCC Part 15.109, RSS 210 Table 2, RSS GEN Table 1 and RSS 310 Table 3. Note that receivers operating outside of the frequency range 30 MHz – 960 MHz are exempt from the requirements of 15.109.

Frequency Range (MHz)	Limit (uV/m @ 3m)	Limit (dBuV/m @ 3m)
30 to 88	100	40
88 to 216	150	43.5
216 to 960	200	46.0
Above 960	500	54.0

¹ The restricted bands are detailed in FCC 15.203, RSS 210 Table 1 and RSS 310 Table 2

OUTPUT POWER LIMITS – FHSS SYSTEMS

The table below shows the limits for output power based on the number of channels available for the hopping system.

Operating Frequency (MHz)	Number of Channels	Output Power
902 – 928	≥ 50	1 Watt (30 dBm)
902 – 928	25 to 49	0.25 Watts (24 dBm)
2400 – 2483.5	≥ 75	1 Watt (30 dBm)
2400 – 2483.5	< 75	0.125 Watts (21 dBm)
5725 – 5850	75	1 Watt (30 dBm)

The maximum permitted output power is reduced by 1dB for every dB the antenna gain exceeds 6dBi. Fixed point-to-point applications using the 5725 – 5850 MHz band are not subject to this restriction.

TRANSMIT MODE SPURIOUS RADIATED EMISSIONS LIMITS – FHSS and DTS SYSTEMS

The limits for unwanted (spurious) emissions from the transmitter falling in the restricted bands are those specified in the general limits sections of FCC Part 15 and RSS 210. All other unwanted (spurious) emissions shall be at least 20dB below the level of the highest in-band signal level (30dB if the power is measured using the sample detector/power averaging method).

FCC 15.407 (a) OUTPUT POWER LIMITS

The table below shows the limits for output power and output power density. Where the signal bandwidth is less than 20 MHz the maximum output power is reduced to the power spectral density limit plus 10 times the log of the bandwidth (in MHz).

Operating Frequency (MHz)	Output Power	Power Spectral Density
5150 – 5250	50mW (17 dBm)	4 dBm/MHz
5250 – 5350	250 mW (24 dBm)	11 dBm/MHz
5725 – 5825	1 Watts (30 dBm)	17 dBm/MHz

For system using antennas with gains exceeding 6dBi, the output power and power spectral density limits are reduced by 1dB for every dB the antenna gain exceeds 6dBi. Fixed point-to-point applications using the 5725 – 5825 MHz band may use antennas with gains of up to 23dBi without this limitation. If the gain exceeds 23dBi then the output power limit of 1 Watt is reduced by 1dB for every dB the gain exceeds 23dBi.

The peak excursion envelope is limited to 13dB.

OUTPUT POWER LIMITS –LELAN DEVICES

The table below shows the limits for output power and output power density defined by RSS 210. Where the signal bandwidth is less than 20 MHz the maximum output power is reduced to the power spectral density limit plus 10 times the log of the bandwidth (in MHz).

Operating Frequency (MHz)	Output Power	Power Spectral Density
5150 – 5250	200mW (23 dBm) eirp	10 dBm/MHz eirp
5250 – 5350	250 mW (24 dBm) ² 1W (30dBm) eirp	11 dBm/MHz
5470 – 5725	250 mW (24 dBm) ³ 1W (30dBm) eirp	11 dBm/MHz
5725 – 5825	1 Watts (30 dBm) 4W eirp	17 dBm/MHz

In addition, the power spectral density limit shall be reduced by 1dB for every dB the highest power spectral density exceeds the “average” power spectral density) by more than 3dB. The “average” power spectral density is determined by dividing the output power by $10\log(\text{EBW})$ where EBW is the 99% power bandwidth.

Fixed point-to-point applications using the 5725 – 5825 MHz band may use antennas with gains of up to 23dBi without this limitation. If the gain exceeds 23dBi then the output power limit of 1 Watt is reduced by 1dB for every dB the gain exceeds 23dBi.

SPURIOUS EMISSIONS LIMITS –UNII and LELAN DEVICES

The spurious emissions limits for signals below 1GHz are the FCC/RSS-GEN general limits. For emissions above 1GHz, signals in restricted bands are subject to the FCC/RSS GEN general limits. All other signals have a limit of -27dBm/MHz , which is a field strength of 68.3dBuV/m/MHz at a distance of 3m. This is an average limit so the peak value of the emission may not exceed -7dBm/MHz (88.3dBuV/m/MHz at a distance of 3m). For devices operating in the 5725-5850Mhz bands under the LELAN/UNII rules, the limit within 10Mhz of the allocated band is increased to -17dBm/MHz .

SAMPLE CALCULATIONS - CONDUCTED EMISSIONS

Receiver readings are compared directly to the conducted emissions specification limit (decibel form) as follows:

$$R_r - S = M$$

where:

R_r = Receiver Reading in dBuV

S = Specification Limit in dBuV

M = Margin to Specification in +/- dB

² If EIRP exceeds 500mW the device must employ TPC

³ If EIRP exceeds 500mW the device must employ TPC

SAMPLE CALCULATIONS - RADIATED EMISSIONS

Receiver readings are compared directly to the specification limit (decibel form). The receiver internally corrects for cable loss, preamplifier gain, and antenna factor. The calculations are in the reverse direction of the actual signal flow, thus cable loss is added and the amplifier gain is subtracted. The Antenna Factor converts the voltage at the antenna coaxial connector to the field strength at the antenna elements.

A distance factor, when used for electric field measurements above 30MHz, is calculated by using the following formula:

$$F_d = 20 * \text{LOG}_{10} (D_m/D_s)$$

where:

$$F_d = \text{Distance Factor in dB}$$

$$D_m = \text{Measurement Distance in meters}$$

$$D_s = \text{Specification Distance in meters}$$

For electric field measurements below 30MHz the extrapolation factor is either determined by making measurements at multiple distances or a theoretical value is calculated using the formula:

$$F_d = 40 * \text{LOG}_{10} (D_m/D_s)$$

Measurement Distance is the distance at which the measurements were taken and Specification Distance is the distance at which the specification limits are based. The antenna factor converts the voltage at the antenna coaxial connector to the field strength at the antenna elements.

The margin of a given emission peak relative to the limit is calculated as follows:

$$R_c = R_r + F_d$$

and

$$M = R_c - L_s$$

where:

$$R_r = \text{Receiver Reading in dBuV/m}$$

$$F_d = \text{Distance Factor in dB}$$

$$R_c = \text{Corrected Reading in dBuV/m}$$

$$L_s = \text{Specification Limit in dBuV/m}$$

$$M = \text{Margin in dB Relative to Spec}$$

SAMPLE CALCULATIONS - FIELD STRENGTH TO EIRP CONVERSION

Where the radiated electric field strength is expressed in terms of the equivalent isotropic radiated power (eirp), or where a field strength measurement of output power is made in lieu of a direct measurement, the following formula is used to convert between eirp and field strength at a distance of d (meters) from the equipment under test:

$$E = \frac{1000000 \sqrt{30 P}}{d} \quad \text{microvolts per meter}$$

where P is the eirp (Watts)

For a measurement at 3m the conversion from a logarithmic value for field strength (dBuV/m) to an eirp power (dBm) is -95.3dB.

Appendix A Test Equipment Calibration Data**Radio Antenna Port (Power and Spurious Emissions), 24-Aug-11**

<u>Manufacturer</u>	<u>Description</u>	<u>Model</u>	<u>Asset #</u>	<u>Cal Due</u>
Hewlett Packard	SpecAn 9 kHz - 40 GHz, FT (SA40) Blue	8564E (84125C)	1393	8/9/2012
Rohde & Schwarz	EMI Test Receiver, 20 Hz-7 GHz	ESIB7	1538	11/2/2011

Radiated Emissions, 1000 - 18,000 MHz, 28-Dec-11

<u>Manufacturer</u>	<u>Description</u>	<u>Model</u>	<u>Asset #</u>	<u>Cal Due</u>
EMCO	Antenna, Horn, 1-18 GHz (SA40-Blu)	3115	1386	9/21/2012
Hewlett Packard	Microwave Preamplifier, 1-26.5GHz	8449B	2199	2/23/2012
Hewlett Packard	SpecAn 9 kHz - 40 GHz, (SA40) Purple	8564E (84125C)	2415	7/28/2012

Radiated Emissions, 1000 - 18,000 MHz, 29-Dec-11

<u>Manufacturer</u>	<u>Description</u>	<u>Model</u>	<u>Asset #</u>	<u>Cal Due</u>
Hewlett Packard	Microwave Preamplifier, 1-26.5GHz	8449B	263	12/9/2012
Hewlett Packard	SpecAn 30 Hz -40 GHz, SV (SA40) Red	8564E (84125C)	1148	8/15/2012
EMCO	Antenna, Horn, 1-18 GHz	3115	1561	6/22/2012
Micro-Tronics	Band Reject Filter, 5150-5350 MHz	BRC50703-02	2239	10/4/2012

Radiated Emissions, 1000 - 18,000 MHz, 30-Dec-11

<u>Manufacturer</u>	<u>Description</u>	<u>Model</u>	<u>Asset #</u>	<u>Cal Due</u>
Hewlett Packard	Microwave Preamplifier, 1-26.5GHz	8449B	263	12/9/2012
Hewlett Packard	SpecAn 30 Hz -40 GHz, SV (SA40) Red	8564E (84125C)	1148	8/15/2012
EMCO	Antenna, Horn, 1-18 GHz	3115	1561	6/22/2012
Micro-Tronics	Band Reject Filter, 5470-5725 MHz	BRC50704-02	1681	9/8/2012
Micro-Tronics	Band Reject Filter, 5150-5350 MHz	BRC50703-02	2239	10/4/2012

Radiated Emissions, 1000 - 18,000 MHz, 04-Jan-12

<u>Manufacturer</u>	<u>Description</u>	<u>Model</u>	<u>Asset #</u>	<u>Cal Due</u>
EMCO	Antenna, Horn, 1-18 GHz (SA40-Blu)	3115	1386	9/21/2012
Micro-Tronics	Band Reject Filter, 5150-5350 MHz	BRC50703-02	1729	8/5/2012
Hewlett Packard	Microwave Preamplifier, 1-26.5GHz	8449B	2199	2/23/2012
Hewlett Packard	SpecAn 9 kHz - 40 GHz, (SA40) Purple	8564E (84125C)	2415	7/28/2012

Conducted Emissions - AC Power Ports, 16-Dec-11

<u>Manufacturer</u>	<u>Description</u>	<u>Model</u>	<u>Asset #</u>	<u>Cal Due</u>
EMCO	LISN, 10 kHz-100 MHz, 25A	3825/2	1292	3/1/2012
Rohde & Schwarz	EMI Test Receiver, 20 Hz-7 GHz	ESIB7	1756	4/6/2012

Appendix B Test Data

T83196 Pages 28 – 75

T83198 Pages 76 - 84

Client:	Summit Data Communications	Job Number:	J78403
Model:	SDC-MSD40NBT (1x1 802.11abg + BT 2.1)	T-Log Number:	T83196
		Account Manager:	Christine Krebill
Contact:	Ron Seide		-
Emissions Standard(s):	FCC 15.E/RSS-210	Class:	-
Immunity Standard(s):	-	Environment:	-

EMC Test Data

For The

Summit Data Communications

Model

SDC-MSD40NBT (1x1 802.11abg + BT 2.1)

Date of Last Test: 1/6/2012

Client:	Summit Data Communications	Job Number:	J78403
Model:	SDC-MSD40NBT (1x1 802.11abg + BT 2.1)	T-Log Number:	T83196
Contact:	Ron Seide	Account Manager:	Christine Krebill
Standard:	FCC 15.E/RSS-210	Class:	N/A

RSS 210 and FCC 15.407 (UNII) Radiated Spurious Emissions

Summary of Results

SCU: v3.03.07

Run #	Mode	Channel	Antenna	Power Setting	Test Performed	Limit	Result / Margin
Run # 1	802.11a Chain A	#36 5180MHz	Larsen	-	Restricted Band Edge at 5150 MHz	15.209	43.9dBµV/m @ 5143.9MHz (-10.1dB)
Run # 1	802.11a Chain A	#56 5280MHz	Larsen	-	Restricted Band Edge at 5250 MHz	LP0002 (Taiwan Only)	44.9dBµV/m @ 5248.1MHz (-9.1dB)
Run # 1	802.11a Chain A	#64 5320MHz	Larsen	-	Restricted Band Edge at 5350 MHz	15.209	47.3dBµV/m @ 5362.8MHz (-6.7dB)
Run # 1	802.11a Chain A	#100 5500MHz	Larsen	-	Restricted Band Edge at 5460 MHz	15.209	47.6dBµV/m @ 5458.7MHz (-6.4dB)
Run # 2	802.11n20 Chain A	#36 5180MHz	Larsen	-	Restricted Band Edge at 5150 MHz	15.209	43.9dBµV/m @ 5143.6MHz (-10.1dB)
Run # 2	802.11n20 Chain A	#56 5280MHz	Larsen	-	Restricted Band Edge at 5250 MHz	LP0002 (Taiwan Only)	43.9dBµV/m @ 5241.2MHz (-10.1dB)
Run # 2	802.11n20 Chain A	#64 5320MHz	Larsen	-	Restricted Band Edge at 5350 MHz	15.209	45.8dBµV/m @ 5359.5MHz (-8.2dB)
Run # 2	802.11n20 Chain A	#100 5500MHz	Larsen	-	Restricted Band Edge at 5460 MHz	15.209	43.6dBµV/m @ 5458.7MHz (-10.4dB)

Client:	Summit Data Communications	Job Number:	J78403
Model:	SDC-MSD40NBT (1x1 802.11abg + BT 2.1)	T-Log Number:	T83196
		Account Manager:	Christine Krebill
Contact:	Ron Seide		
Standard:	FCC 15.E/RSS-210	Class:	N/A

Test Specific Details

Objective: The objective of this test session is to perform engineering evaluation testing of the EUT with respect to the specification listed above.

General Test Configuration

The EUT was installed into a test fixture such that the EUT was exposed (i.e. outside of a host PC). For radiated emissions testing the measurement antenna was located 3 meters from the EUT.

Ambient Conditions:

Rel. Humidity: 15 - 55 %
Temperature: 18 - 25 °C

Modifications Made During Testing

No modifications were made to the EUT during testing

Deviations From The Standard

No deviations were made from the requirements of the standard.

Client:	Summit Data Communications	Job Number:	J78403
Model:	SDC-MSD40NBT (1x1 802.11abg + BT 2.1)	T-Log Number:	T83196
Contact:	Ron Seide	Account Manager:	Christine Krebill
Standard:	FCC 15.E/RSS-210	Class:	N/A

Run # 1, Band Edge Field Strength - 802.11a, Chain A
Run # 1a, EUT on Channel #36 5180MHz - 802.11a, Chain A

Date of Test: 12/28/2011
Test Engineer: Rafael Varelas

Test Location: FT Chamber #4
Config Change: None

Direct Measurement of Field Strength at the bandedge

Frequency MHz	Level dB μ V/m	Pol v/h	15.209 / 15.247		Detector Pk/QP/Avg	Azimuth degrees	Height meters	Comments
			Limit	Margin				
5143.900	43.9	V	54.0	-10.1	AVG	135	1.0	RB 1 MHz;VB 10 Hz;Pk
5134.130	54.8	V	74.0	-19.2	PK	135	1.0	RB 1 MHz;VB 3 MHz;Pk
5136.630	42.5	H	54.0	-11.5	AVG	269	1.3	RB 1 MHz;VB 10 Hz;Pk
5131.170	54.5	H	74.0	-19.5	PK	269	1.3	RB 1 MHz;VB 3 MHz;Pk

RB 1 MHz; VB 10 Hz Avg (Black Trace); Pk (Blue Trace) Vertical

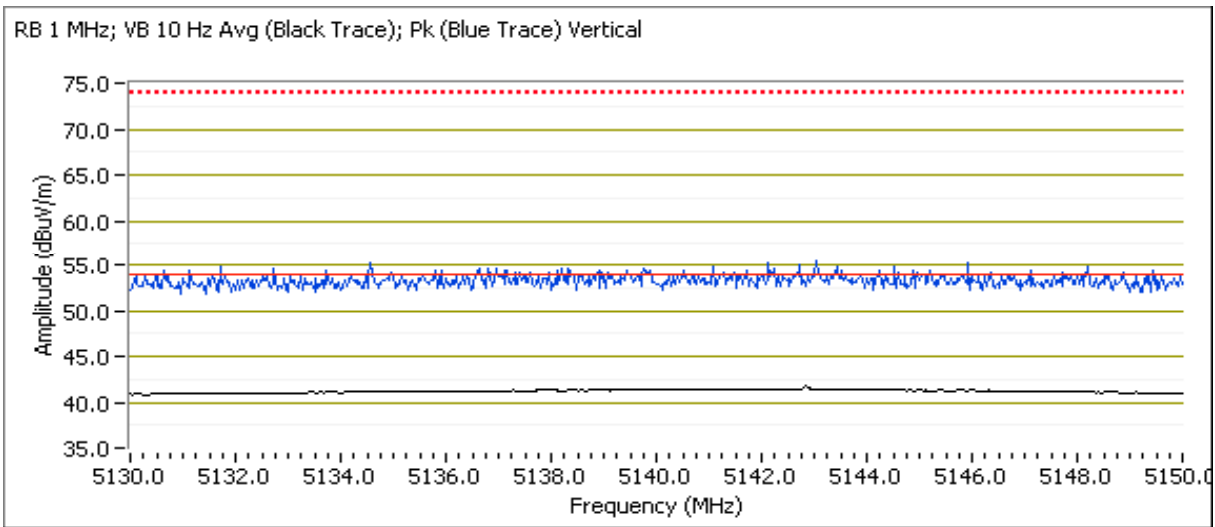

Client:	Summit Data Communications	Job Number:	J78403
Model:	SDC-MSD40NBT (1x1 802.11abg + BT 2.1)	T-Log Number:	T83196
Contact:	Ron Seide	Account Manager:	Christine Krebill
Standard:	FCC 15.E/RSS-210	Class:	N/A

Run # 1b, EUT on Channel #56 5280MHz - 802.11a, Chain A

For Taiwan Only
5250MHz Band Edge Signal Radiated Field Strength

Frequency MHz	Level dB μ V/m	Pol v/h	LP0002		Detector Pk/QP/Avg	Azimuth degrees	Height meters	Comments
			Limit	Margin				
5248.130	44.9	V	54.0	-9.1	AVG	153	1.0	RB 1 MHz;VB 10 Hz;Pk
5249.570	59.6	V	74.0	-14.4	PK	153	1.0	RB 1 MHz;VB 3 MHz;Pk
5230.470	42.4	H	54.0	-11.6	AVG	349	1.0	RB 1 MHz;VB 10 Hz;Pk
5238.470	53.4	H	74.0	-20.6	PK	349	1.0	RB 1 MHz;VB 3 MHz;Pk

RB 1 MHz; VB 10 Hz Avg (Black Trace); Pk (Blue Trace) Vertical

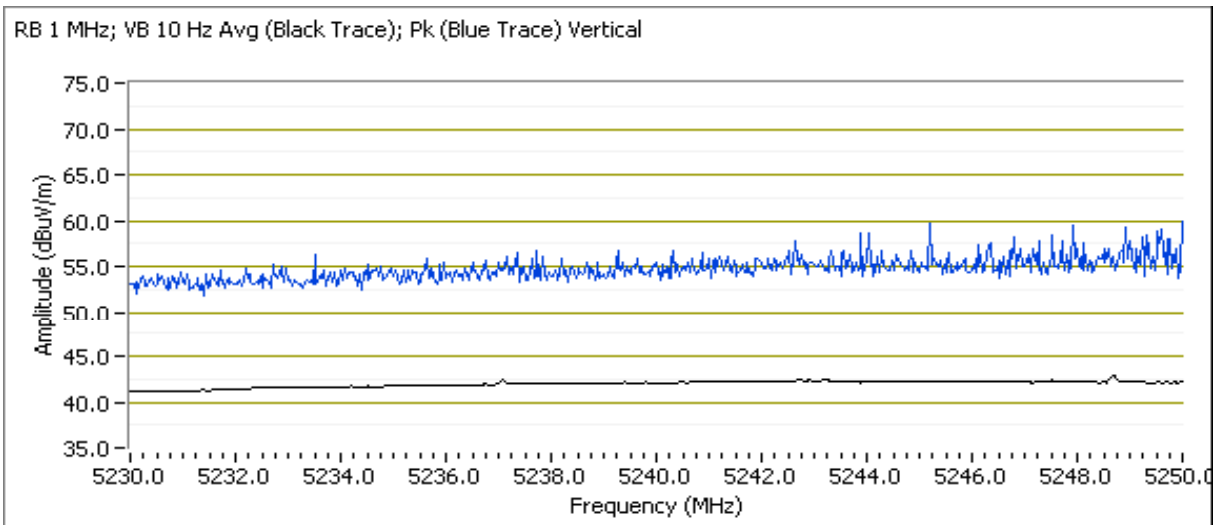

Client:	Summit Data Communications	Job Number:	J78403
Model:	SDC-MSD40NBT (1x1 802.11abg + BT 2.1)	T-Log Number:	T83196
Contact:	Ron Seide	Account Manager:	Christine Krebill
Standard:	FCC 15.E/RSS-210	Class:	N/A

Run # 1c, EUT on Channel #64 5320MHz - 802.11a, Chain A
 Date of Test: 12/28/2011
 Test Engineer: Rafael Varelas
 Test Location: FT Chamber #4
 Config Change: None

Direct Measurement of Field Strength at the bandedge

Frequency	Level	Pol	15.209 / 15.247		Detector	Azimuth	Height	Comments
MHz	dB μ V/m	v/h	Limit	Margin	Pk/QP/Avg	degrees	meters	
5362.830	47.3	V	54.0	-6.7	AVG	155	1.0	RB 1 MHz;VB 10 Hz;Pk
5363.500	58.4	V	74.0	-15.6	PK	155	1.0	RB 1 MHz;VB 3 MHz;Pk
5364.670	43.5	H	54.0	-10.5	AVG	146	1.0	RB 1 MHz;VB 10 Hz;Pk
5358.630	55.6	H	74.0	-18.4	PK	146	1.0	RB 1 MHz;VB 3 MHz;Pk

RB 1 MHz; VB 10 Hz Avg (Black Trace); Pk (Blue Trace) Vertical

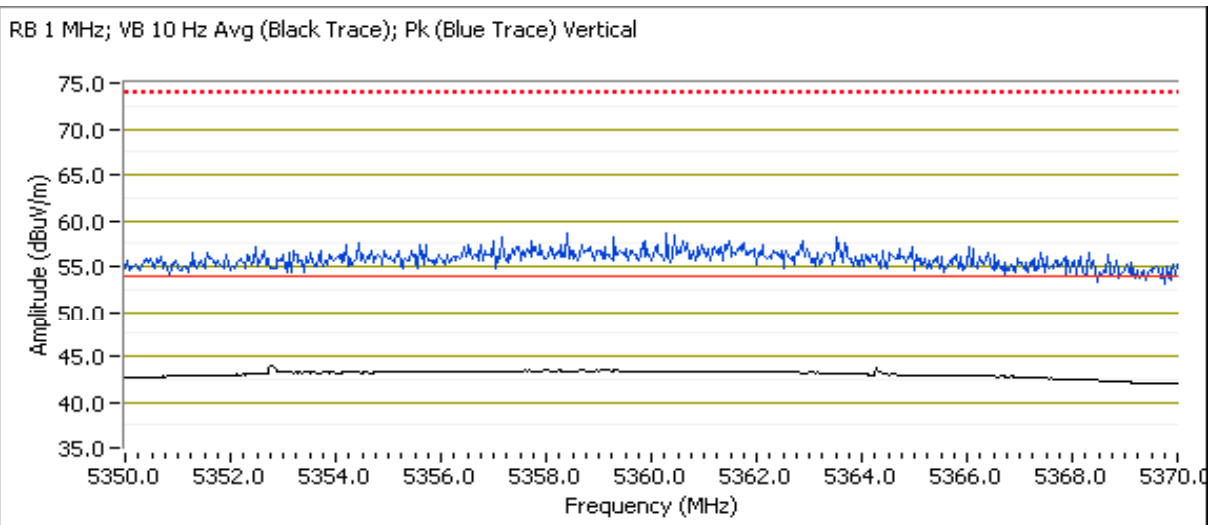

Client:	Summit Data Communications	Job Number:	J78403
Model:	SDC-MSD40NBT (1x1 802.11abg + BT 2.1)	T-Log Number:	T83196
Contact:	Ron Seide	Account Manager:	Christine Krebill
Standard:	FCC 15.E/RSS-210	Class:	N/A

Run # 1d, EUT on Channel #100 5500MHz - 802.11a, Chain A

Direct Measurement of Field Strength at the bandedge @ 5460 MHz

Frequency	Level	Pol	15.209 / 15.247		Detector	Azimuth	Height	Comments
MHz	dB μ V/m	v/h	Limit	Margin	Pk/QP/Avg	degrees	meters	
5458.670	47.6	V	54.0	-6.4	AVG	190	1.0	RB 1 MHz;VB 10 Hz;Pk
5458.200	60.7	V	74.0	-13.3	PK	190	1.0	RB 1 MHz;VB 3 MHz;Pk
5455.200	43.6	H	54.0	-10.4	AVG	89	1.1	RB 1 MHz;VB 10 Hz;Pk
5456.870	55.0	H	74.0	-19.0	PK	89	1.1	RB 1 MHz;VB 3 MHz;Pk

RB 1 MHz; VB 10 Hz Avg (Black Trace); Pk (Blue Trace) Vertical

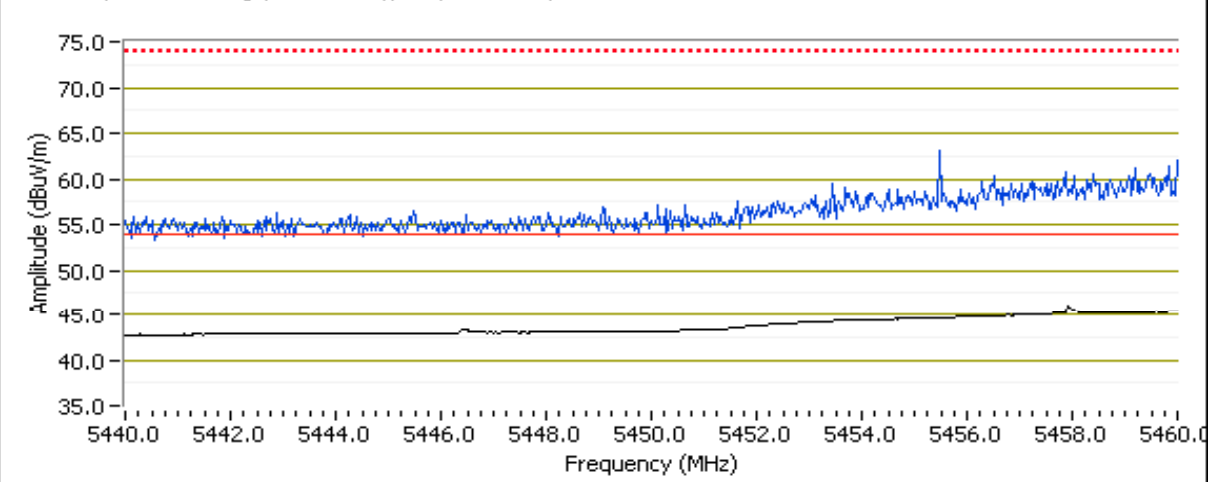

Client:	Summit Data Communications	Job Number:	J78403
Model:	SDC-MSD40NBT (1x1 802.11abg + BT 2.1)	T-Log Number:	T83196
Contact:	Ron Seide	Account Manager:	Christine Krebill
Standard:	FCC 15.E/RSS-210	Class:	N/A

Run # 2, Band Edge Field Strength - 802.11n20, Chain A

Run # 2a, EUT on Channel #36 5180MHz - 802.11n20, Chain A

Date of Test: 12/28/2011

Test Location: FT Chamber #4

Test Engineer: Rafael Varelas

Config Change: None

Direct Measurement of Field Strength at the bandedge

Frequency MHz	Level dB μ V/m	Pol v/h	15.209 / 15.247		Detector Pk/QP/Avg	Azimuth degrees	Height meters	Comments
			Limit	Margin				
5143.600	43.9	V	54.0	-10.1	AVG	172	1.0	RB 1 MHz;VB 10 Hz;Pk
5136.300	54.4	V	74.0	-19.6	PK	172	1.0	RB 1 MHz;VB 3 MHz;Pk
5131.830	42.6	H	54.0	-11.4	AVG	276	1.0	RB 1 MHz;VB 10 Hz;Pk
5141.330	54.3	H	74.0	-19.7	PK	276	1.0	RB 1 MHz;VB 3 MHz;Pk

RB 1 MHz; VB 10 Hz Avg (Black Trace); Pk (Blue Trace) Vertical

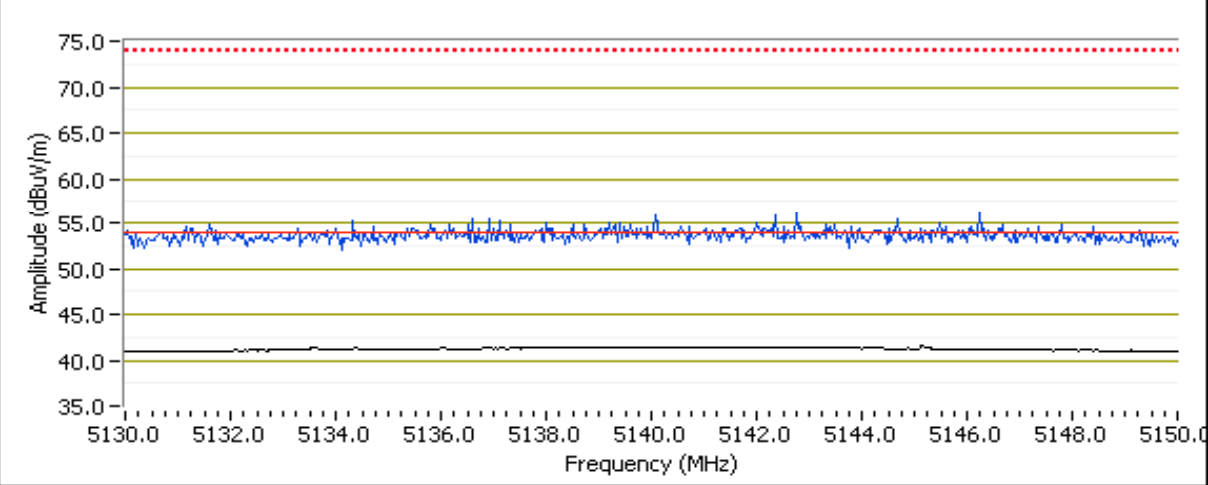

Client:	Summit Data Communications	Job Number:	J78403
Model:	SDC-MSD40NBT (1x1 802.11abg + BT 2.1)	T-Log Number:	T83196
Contact:	Ron Seide	Account Manager:	Christine Krebill
Standard:	FCC 15.E/RSS-210	Class:	N/A

Run # 2b, EUT on Channel #56 5280MHz - 802.11n20, Chain A

For Taiwan Only

5250MHz Band Edge Signal Radiated Field Strength

Frequency MHz	Level dB μ V/m	Pol v/h	LP0002		Detector Pk/QP/Avg	Azimuth degrees	Height meters	Comments
			Limit	Margin				
5241.200	43.9	V	54.0	-10.1	AVG	124	1.0	RB 1 MHz;VB 10 Hz;Pk
5247.100	55.3	V	74.0	-18.7	PK	124	1.0	RB 1 MHz;VB 3 MHz;Pk
5230.170	42.4	H	54.0	-11.6	AVG	281	1.1	RB 1 MHz;VB 10 Hz;Pk
5248.570	53.8	H	74.0	-20.2	PK	281	1.1	RB 1 MHz;VB 3 MHz;Pk

RB 1 MHz; VB 10 Hz Avg (Black Trace); Pk (Blue Trace) Vertical

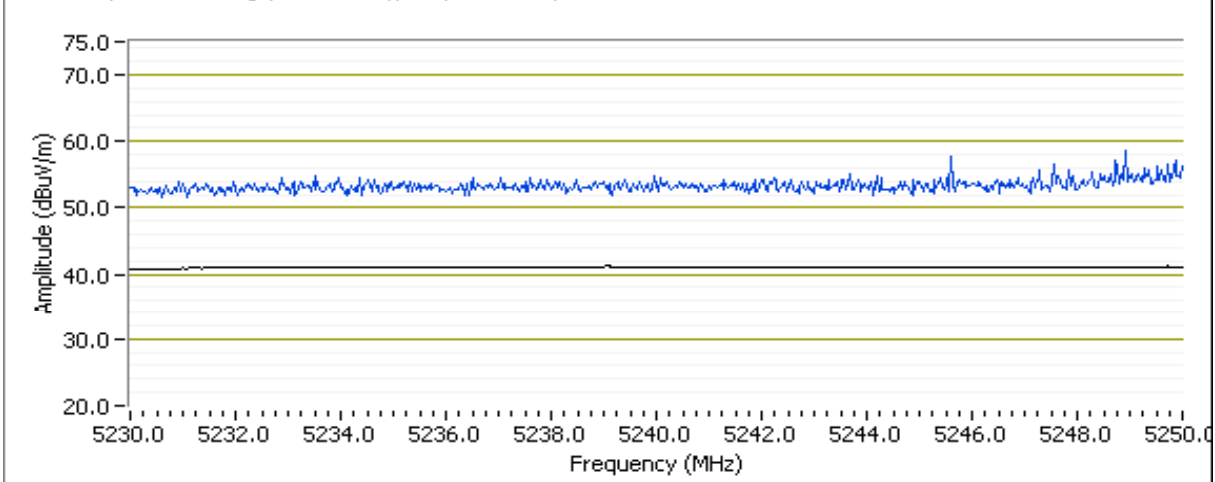

Client:	Summit Data Communications	Job Number:	J78403
Model:	SDC-MSD40NBT (1x1 802.11abg + BT 2.1)	T-Log Number:	T83196
Contact:	Ron Seide	Account Manager:	Christine Krebill
Standard:	FCC 15.E/RSS-210	Class:	N/A

Run # 2c, EUT on Channel #64 5320MHz - 802.11n20, Chain A

Date of Test: 12/28/2011

Test Location: FT Chamber #4

Test Engineer: Rafael Varelas

Config Change: None

Direct Measurement of Field Strength at the bandedge

Frequency	Level	Pol	15.209 / 15.247		Detector	Azimuth	Height	Comments
MHz	dB μ V/m	v/h	Limit	Margin	Pk/QP/Avg	degrees	meters	
5359.500	45.8	V	54.0	-8.2	AVG	189	1.0	RB 1 MHz;VB 10 Hz;Pk
5354.830	56.2	V	74.0	-17.8	PK	189	1.0	RB 1 MHz;VB 3 MHz;Pk
5358.670	43.2	H	54.0	-10.8	AVG	107	1.0	RB 1 MHz;VB 10 Hz;Pk
5355.070	54.6	H	74.0	-19.4	PK	107	1.0	RB 1 MHz;VB 3 MHz;Pk

RB 1 MHz; VB 10 Hz Avg (Black Trace); Pk (Blue Trace) Vertical

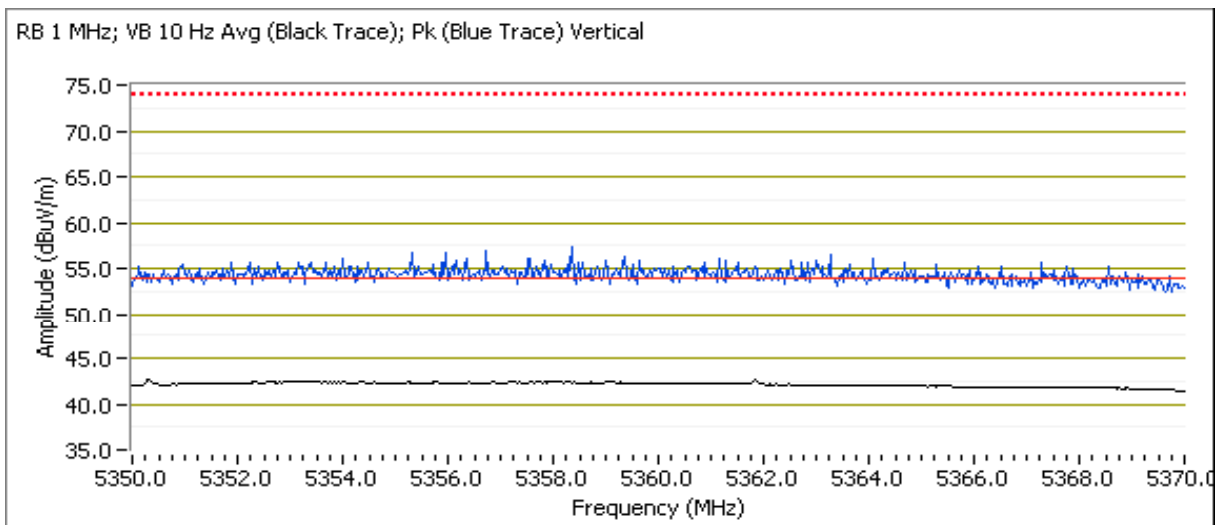

Client:	Summit Data Communications	Job Number:	J78403
Model:	SDC-MSD40NBT (1x1 802.11abg + BT 2.1)	T-Log Number:	T83196
Contact:	Ron Seide	Account Manager:	Christine Krebill
Standard:	FCC 15.E/RSS-210	Class:	N/A

Run # 2d, EUT on Channel #100, 5500MHz - 802.11n20, Chain A

Direct Measurement of Field Strength at the bandedge @ 5460 MHz

Frequency	Level	Pol	15.209 / 15.247		Detector	Azimuth	Height	Comments
MHz	dB μ V/m	v/h	Limit	Margin	Pk/QP/Avg	degrees	meters	
5458.700	43.6	V	54.0	-10.4	AVG	89	1.0	RB 1 MHz;VB 10 Hz;Pk
5441.200	54.4	V	74.0	-19.6	PK	89	1.0	RB 1 MHz;VB 3 MHz;Pk
5457.570	43.6	H	54.0	-10.4	AVG	142	1.0	RB 1 MHz;VB 10 Hz;Pk
5443.130	54.9	H	74.0	-19.1	PK	142	1.0	RB 1 MHz;VB 3 MHz;Pk

RB 1 MHz; VB 10 Hz Avg (Black Trace); Pk (Blue Trace) Vertical

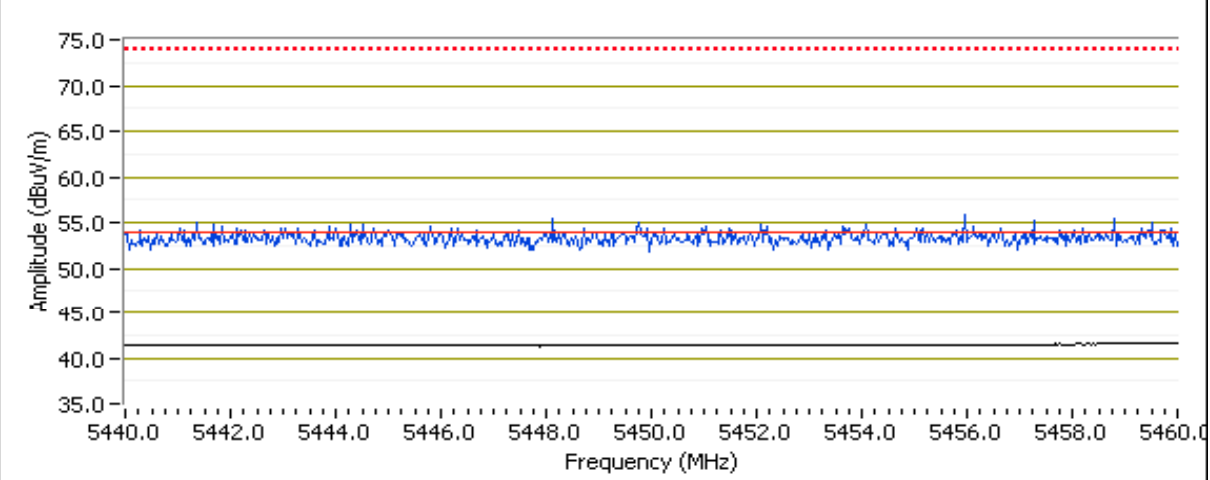

Client:	Summit Data Communications	Job Number:	J78403
Model:	SDC-MSD40NBT (1x1 802.11abg + BT 2.1)	T-Log Number:	T83196
Contact:	Ron Seide	Account Manager:	Christine Krebill
Standard:	FCC 15.E/RSS-210	Class:	N/A

RSS 210 and FCC 15.407 (UNII) Radiated Spurious Emissions

Summary of Results

SCU: v3.03.07

Run #	Mode	Channel	Antenna	Power Setting	Test Performed	Limit	Result / Margin	
Scans on center channel in all three OFDM modes to determine the worst case								
Run #1 (5150-5250MHz Band)	802.11a Chain A	#40 5200MHz	Larsen	-	Radiated Emissions, 1 - 40 GHz	FCC 15.209 / 15 E	42.3dBµV/m @ 1345.6MHz (-11.7dB)	
	n20 Chain A	#40 5200MHz	Larsen	-			42.5dBµV/m @ 1345.6MHz (-11.5dB)	
	Worst case mode/worse case Chain A top and bottom channels.							
	n20 Chain A	#38 5180MHz	Larsen	-	Radiated Emissions, 1 - 40 GHz	FCC 15.209 / 15 E	43.0dBµV/m @ 1345.5MHz (-11.0dB)	
	#48 5240MHz	Larsen	-	42.6dBµV/m @ 1345.6MHz (-11.4dB)				
Run #2 (5250-5350MHz Band)	802.11a Chain A	#60 5300MHz	Larsen	-	Radiated Emissions, 1 - 40 GHz	FCC 15.209 / 15 E	40.3dBµV/m @ 1345.6MHz (-13.7dB)	
	n20 Chain A	#60 5300MHz	Larsen	-			39.4dBµV/m @ 1345.5MHz (-14.6dB)	
	Worst case mode/worse case Chain A top and bottom channels.							
	802.11a Chain A	#52 5260MHz	Larsen	-	Radiated Emissions, 1 - 40 GHz	FCC 15.209 / 15 E	40.8dBµV/m @ 1306.5MHz (-13.2dB)	
	#64 5320MHz	Larsen	-	40.7dBµV/m @ 1306.5MHz (-13.3dB)				

Run #	Mode	Channel	Antenna	Power Setting	Test Performed	Limit	Result / Margin	
Run #3 (5470-5725MHz Band)	802.11a Chain A	#116 5580MHz	Larsen	-	Radiated Emissions, 1 - 40 GHz	FCC 15.209 / 15 E	42.4dBµV/m @ 3720.1MHz (-11.6dB)	
	n20 Chain A	#116 5580MHz	Larsen	-			41.3dBµV/m @ 3720.0MHz (-12.7dB)	
	Worst case mode/worse case Chain A top and bottom channels.							
	802.11a Chain A	#100 5500MHz	Larsen	-	Radiated Emissions, 1 - 40 GHz	FCC 15.209 / 15 E	42.3dBµV/m @ 3666.7MHz (-11.7dB)	
	#140 5700MHz	Larsen	-	41.7dBµV/m @ 3800.1MHz (-12.3dB)				

Client:	Summit Data Communications	Job Number:	J78403
Model:	SDC-MSD40NBT (1x1 802.11abg + BT 2.1)	T-Log Number:	T83196
Contact:	Ron Seide	Account Manager:	Christine Krebill
Standard:	FCC 15.E/RSS-210	Class:	N/A

Receive mode

Run #4	Receive	#40 5200MHz	Larsen	-	Radiated Emissions, 1 - 18 GHz	RSS 210	44.5dBµV/m @ 1345.5MHz (-9.5dB)
		#60 5300MHz	Larsen	-	Radiated Emissions, 1 - 18 GHz	RSS 210	44.4dBµV/m @ 1345.5MHz (-9.6dB)
		#116 5580MHz	Larsen	-	Radiated Emissions, 1 - 18 GHz	RSS 210	44.1dBµV/m @ 1306.5MHz (-9.9dB)

Test Specific Details

Objective: The objective of this test session is to perform engineering evaluation testing of the EUT with respect to the specification listed above.

General Test Configuration

The EUT was installed into a test fixture such that the EUT was exposed (i.e. outside of a host PC).
For radiated emissions testing the measurement antenna was located 3 meters from the EUT.

Ambient Conditions:

Rel. Humidity: 15 - 55 %
Temperature: 18 - 25 °C

Modifications Made During Testing

No modifications were made to the EUT during testing

Deviations From The Standard

No deviations were made from the requirements of the standard.

Client:	Summit Data Communications	Job Number:	J78403
Model:	SDC-MSD40NBT (1x1 802.11abg + BT 2.1)	T-Log Number:	T83196
Contact:	Ron Seide	Account Manager:	Christine Krebill
Standard:	FCC 15.E/RSS-210	Class:	N/A

Run #1, Radiated Spurious Emissions, 1-40GHz, Center Channl 5150-5250MHz - 802.11a, n20
 Date of Test: 12/28/2011 Test Location: FT Chamber #4
 Test Engineer: Rafael Varelas Config Change: None

For emissions in restricted bands, the limit of 15.209 was used. For all other emissions, the limit is -27dBm eirp (68.3dBuV/m @3m).

Run #1a: Channel #40 5200MHz - 802.11a,Chain A

Spurious Radiated Emissions:

Frequency	Level	Pol	15.209 / 15E		Detector	Azimuth	Height	Comments
MHz	dBuV/m	v/h	Limit	Margin	Pk/QP/Avg	degrees	meters	
1345.590	42.3	H	54.0	-11.7	AVG	210	1.0	RB 1 MHz;VB 10 Hz;Pk
1345.240	44.7	H	74.0	-29.3	PK	210	1.0	RB 1 MHz;VB 3 MHz;Pk
3466.750	47.5	H	-	-	Peak	151	1.1	Note 1

Note 1: Emission in non-restricted band, refer to conducted spurious emissions results.

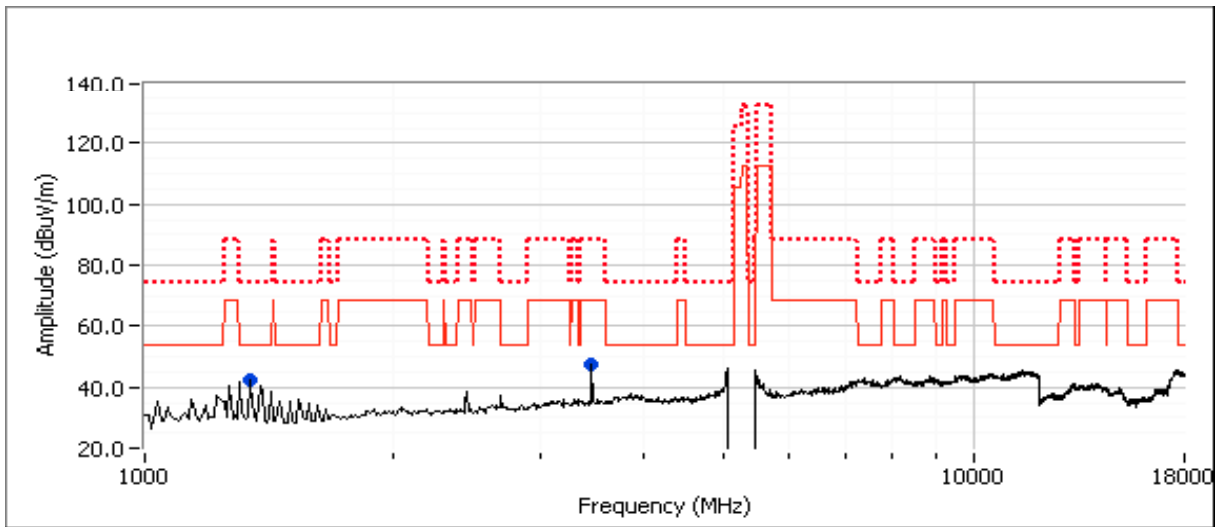

Client:	Summit Data Communications	Job Number:	J78403
Model:	SDC-MSD40NBT (1x1 802.11abg + BT 2.1)	T-Log Number:	T83196
Contact:	Ron Seide	Account Manager:	Christine Krebill
Standard:	FCC 15.E/RSS-210	Class:	N/A

Run #1b: Channel #40 5200MHz - 802.11n20, Chain A

Spurious Radiated Emissions:

Frequency MHz	Level dB μ V/m	Pol v/h	15.209 / 15E		Detector Pk/QP/Avg	Azimuth degrees	Height meters	Comments
			Limit	Margin				
1345.590	42.5	H	54.0	-11.5	AVG	221	1.0	RB 1 MHz;VB 10 Hz;Pk
1345.690	45.2	H	74.0	-28.8	PK	221	1.0	RB 1 MHz;VB 3 MHz;Pk
2700.030	42.5	V	54.0	-11.5	AVG	154	1.8	RB 1 MHz;VB 10 Hz;Pk
2699.850	46.8	V	74.0	-27.2	PK	154	1.8	RB 1 MHz;VB 3 MHz;Pk
3466.750	47.5	H	-	-	Peak	148	1.1	Note 1

Note 1: Emission in non-restricted band, refer to conducted spurious emissions results.

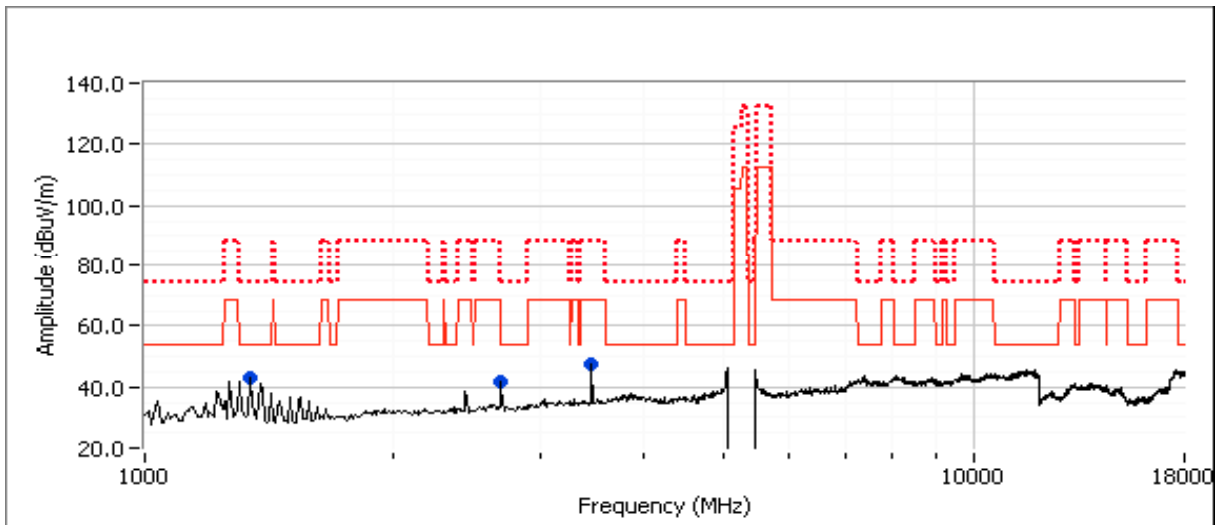

Client:	Summit Data Communications	Job Number:	J78403
Model:	SDC-MSD40NBT (1x1 802.11abg + BT 2.1)	T-Log Number:	T83196
Contact:	Ron Seide	Account Manager:	Christine Krebill
Standard:	FCC 15.E/RSS-210	Class:	N/A

Run #1c: Channel #36 5180MHz - 802.11a

Spurious Radiated Emissions:

Frequency MHz	Level dB μ V/m	Pol v/h	15.209 / 15E		Detector Pk/QP/Avg	Azimuth degrees	Height meters	Comments
			Limit	Margin				
1345.510	43.0	H	54.0	-11.0	AVG	212	1.0	RB 1 MHz;VB 10 Hz;Pk
1345.520	45.7	H	74.0	-28.3	PK	212	1.0	RB 1 MHz;VB 3 MHz;Pk
2700.190	42.8	V	54.0	-11.2	AVG	10	1.8	RB 1 MHz;VB 10 Hz;Pk
2700.490	46.5	V	74.0	-27.5	PK	10	1.8	RB 1 MHz;VB 3 MHz;Pk
3453.450	47.3	H	-	-	Peak	156	1.1	Note 1

Note 1: Emission in non-restricted band, refer to conducted spurious emissions results.

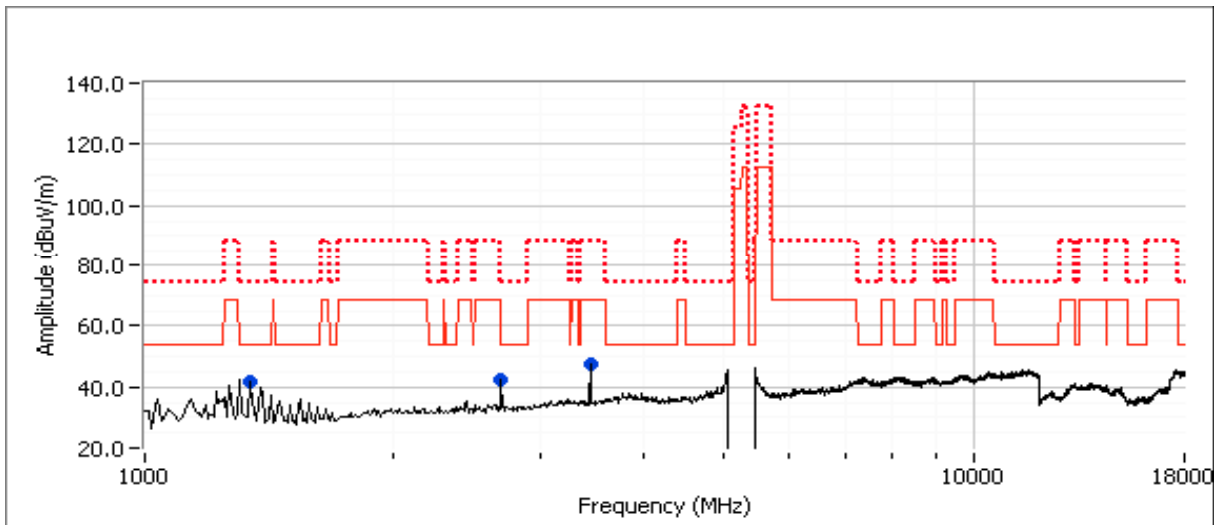

Client:	Summit Data Communications	Job Number:	J78403
Model:	SDC-MSD40NBT (1x1 802.11abg + BT 2.1)	T-Log Number:	T83196
Contact:	Ron Seide	Account Manager:	Christine Krebill
Standard:	FCC 15.E/RSS-210	Class:	N/A

Run #1d: Channel #48 5240MHz - 802.11a

Spurious Radiated Emissions:

Frequency MHz	Level dB μ V/m	Pol v/h	15.209 / 15E		Detector Pk/QP/Avg	Azimuth degrees	Height meters	Comments
			Limit	Margin				
1345.570	42.6	H	54.0	-11.4	AVG	211	1.0	RB 1 MHz;VB 10 Hz;Pk
1345.710	44.9	H	74.0	-29.1	PK	211	1.0	RB 1 MHz;VB 3 MHz;Pk
2700.130	42.4	V	54.0	-11.6	AVG	19	1.8	RB 1 MHz;VB 10 Hz;Pk
2700.330	46.2	V	74.0	-27.8	PK	19	1.8	RB 1 MHz;VB 3 MHz;Pk
3493.510	46.5	H	-	-	Peak	12	1.4	Note 1

Note 1: Emission in non-restricted band, refer to conducted spurious emissions results.

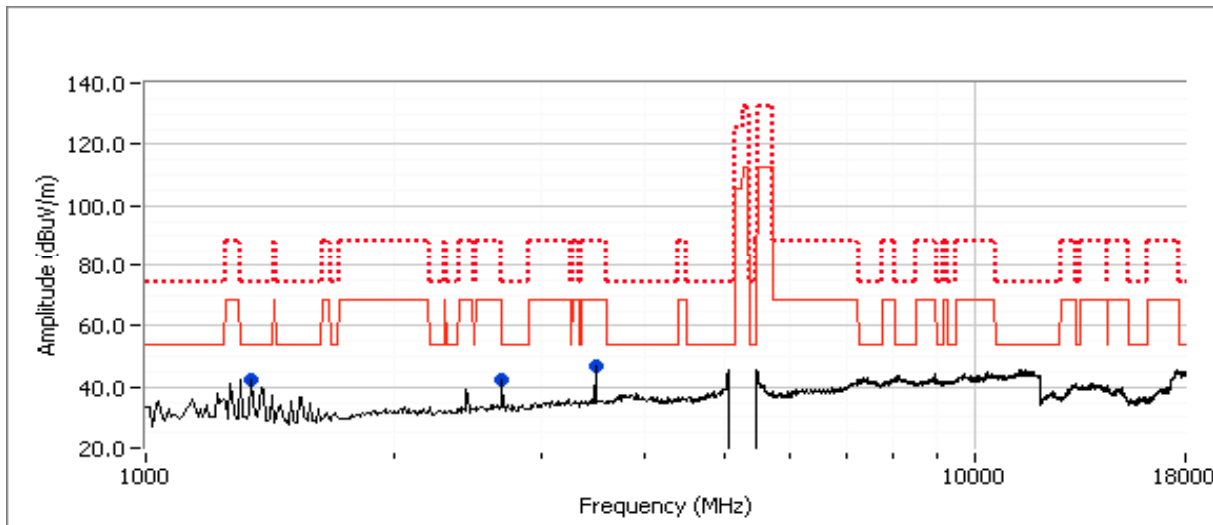

Client:	Summit Data Communications	Job Number:	J78403
Model:	SDC-MSD40NBT (1x1 802.11abg + BT 2.1)	T-Log Number:	T83196
Contact:	Ron Seide	Account Manager:	Christine Krebill
Standard:	FCC 15.E/RSS-210	Class:	N/A

Run #2, Radiated Spurious Emissions, 1-40GHz, Center Channel 5250-5350MHz - 802.11a, n20
 Date of Test: 12/29/2011 Test Location: FT Chamber #4
 Test Engineer: Rafael Varelas Config Change: None

For emissions in restricted bands, the limit of 15.209 was used. For all other emissions, the limit is -27dBm eirp (68.3dBuV/m @3m).

Run #2a: Channel #60 5300MHz - 802.11a,Chain A

Spurious Radiated Emissions:

Frequency	Level	Pol	15.209 / 15E		Detector	Azimuth	Height	Comments
MHz	dBuV/m	v/h	Limit	Margin	Pk/QP/Avg	degrees	meters	
1345.620	40.3	H	54.0	-13.7	AVG	210	1.0	RB 1 MHz;VB 10 Hz;Pk
1345.940	43.3	H	74.0	-30.7	PK	210	1.0	RB 1 MHz;VB 3 MHz;Pk
5449.590	57.2	V	-	-	PK	131	1.0	Note 1
3530.180	45.6	H	-	-	Peak	152	1.3	Note 2

Note 1: Refer to bandedge data - this frequency band has been evaluated

Note 2: Emission in non-restricted band, refer to conducted spurious emissions results.

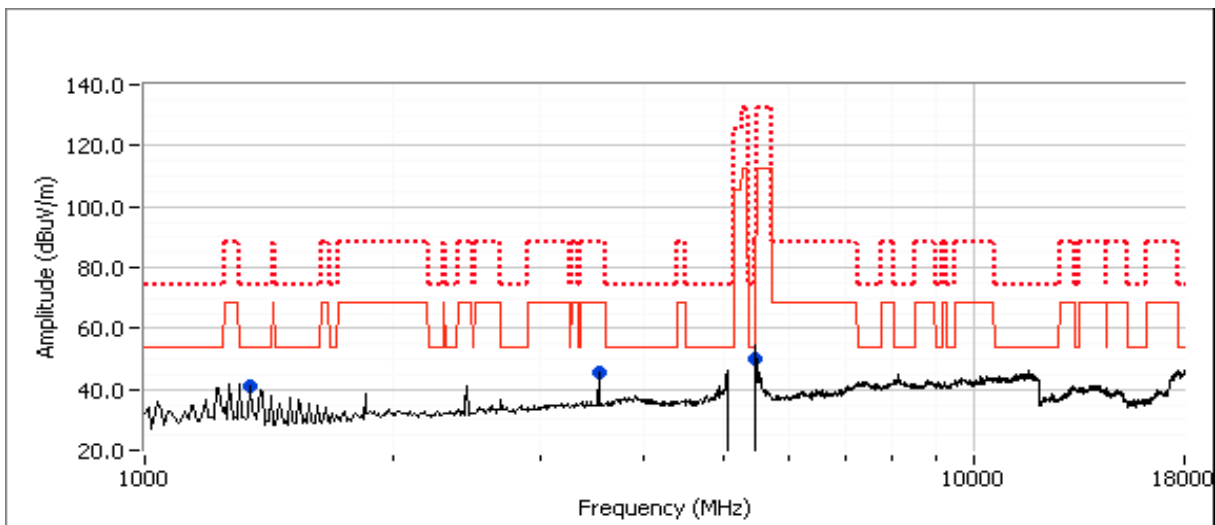

Client:	Summit Data Communications	Job Number:	J78403
Model:	SDC-MSD40NBT (1x1 802.11abg + BT 2.1)	T-Log Number:	T83196
Contact:	Ron Seide	Account Manager:	Christine Krebill
Standard:	FCC 15.E/RSS-210	Class:	N/A

Run #2b: Channel #60 5300MHz - 802.11n20,Chain A

Spurious Radiated Emissions:

Frequency	Level	Pol	15.209 / 15E		Detector	Azimuth	Height	Comments
MHz	dB μ V/m	v/h	Limit	Margin	Pk/QP/Avg	degrees	meters	
1345.500	39.4	H	54.0	-14.6	AVG	273	1.0	RB 1 MHz;VB 10 Hz;Pk
1345.280	43.1	H	74.0	-30.9	PK	273	1.0	RB 1 MHz;VB 3 MHz;Pk
5457.860	50.7	V	-	-	Peak	157	1.3	Note 1
3533.390	45.6	H	-	-	Peak	10	1.6	Note 2

Note 1: Refer to bandedge data - this frequency band has been evaluated

Note 2: Emission in non-restricted band, refer to conducted spurious emissions results.

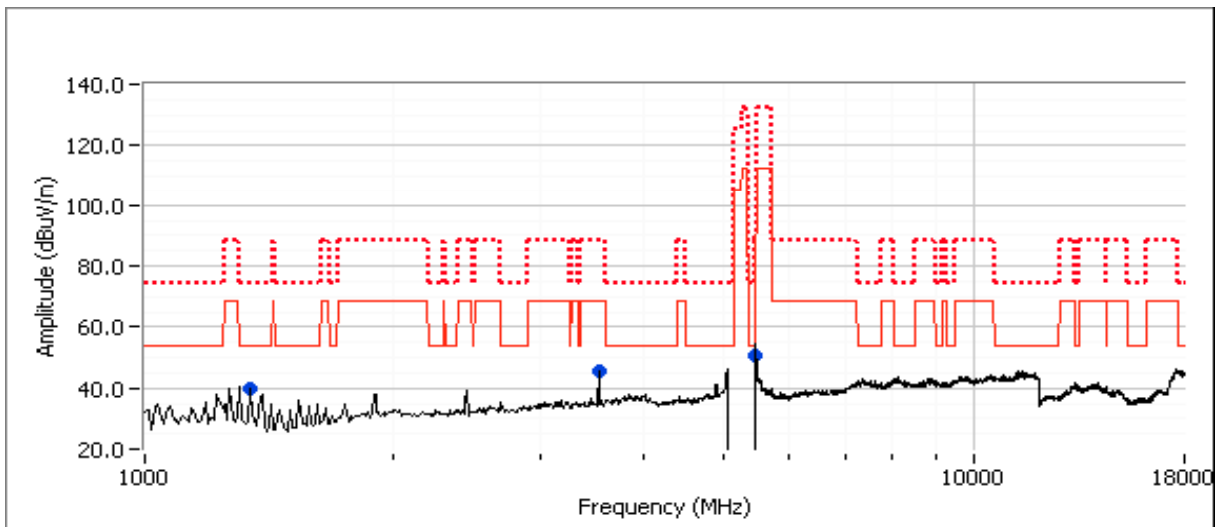

Client:	Summit Data Communications	Job Number:	J78403
Model:	SDC-MSD40NBT (1x1 802.11abg + BT 2.1)	T-Log Number:	T83196
Contact:	Ron Seide	Account Manager:	Christine Krebill
Standard:	FCC 15.E/RSS-210	Class:	N/A

Run #2c: Channel #52 5260MHz - 802.11a

Spurious Radiated Emissions:

Frequency MHz	Level dB μ V/m	Pol v/h	15.209 / 15E		Detector Pk/QP/Avg	Azimuth degrees	Height meters	Comments
			Limit	Margin				
1306.520	40.8	H	54.0	-13.2	AVG	203	1.0	RB 1 MHz;VB 10 Hz;Pk
1306.450	44.0	H	74.0	-30.0	PK	203	1.0	RB 1 MHz;VB 3 MHz;Pk
3506.800	46.2	H	-	-	Peak	12	1.6	Note 1

Note 1: Emission in non-restricted band, refer to conducted spurious emissions results.

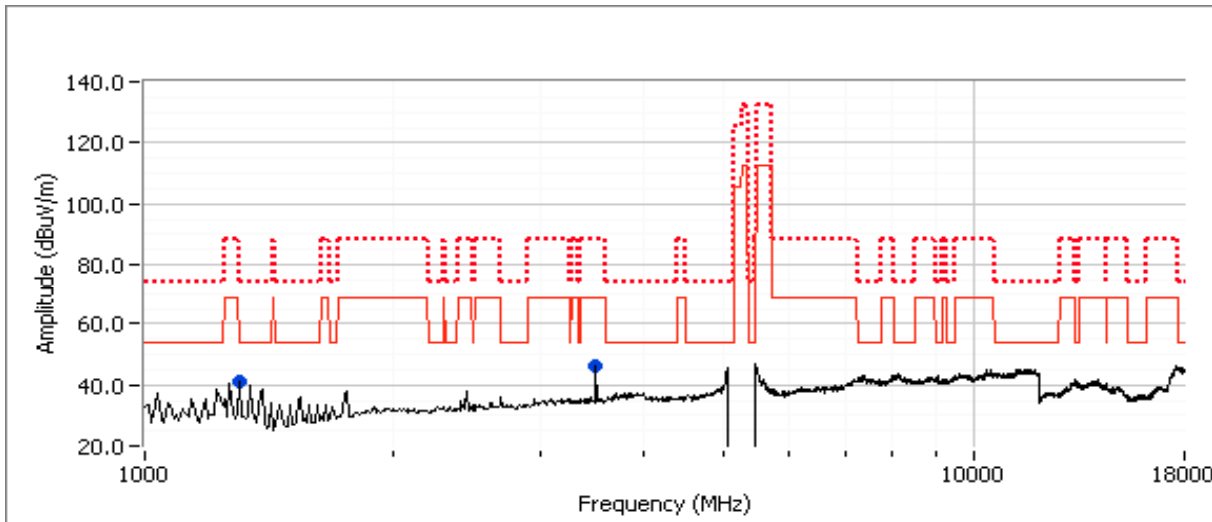

Client:	Summit Data Communications	Job Number:	J78403
Model:	SDC-MSD40NBT (1x1 802.11abg + BT 2.1)	T-Log Number:	T83196
Contact:	Ron Seide	Account Manager:	Christine Krebill
Standard:	FCC 15.E/RSS-210	Class:	N/A

Run #2d: Channel #64 5320MHz - 802.11a

Spurious Radiated Emissions:

Frequency	Level	Pol	15.209 / 15E		Detector	Azimuth	Height	Comments
MHz	dB μ V/m	v/h	Limit	Margin	Pk/QP/Avg	degrees	meters	
1306.500	40.7	H	54.0	-13.3	AVG	201	1.0	RB 1 MHz;VB 10 Hz;Pk
1306.510	43.8	H	74.0	-30.2	PK	201	1.0	RB 1 MHz;VB 3 MHz;Pk
3546.770	46.3	H	-	-	Peak	153	1.3	Note 1

Note 1: Emission in non-restricted band, refer to conducted spurious emissions results.

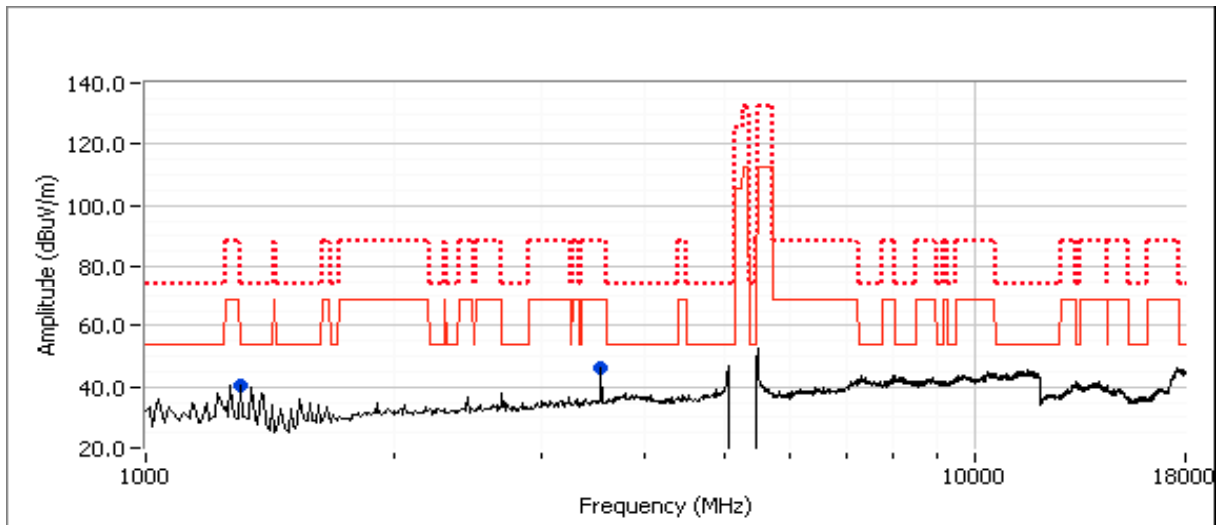

Client:	Summit Data Communications	Job Number:	J78403
Model:	SDC-MSD40NBT (1x1 802.11abg + BT 2.1)	T-Log Number:	T83196
Contact:	Ron Seide	Account Manager:	Christine Krebill
Standard:	FCC 15.E/RSS-210	Class:	N/A

Run #3, Radiated Spurious Emissions, 1-40GHz, Center Channel 5470-5725MHz - 802.11a, n20
 Date of Test: 12/29/2011 Test Location: FT Chamber #4
 Test Engineer: Rafael Varelas Config Change: None

For emissions in restricted bands, the limit of 15.209 was used. For all other emissions, the limit is -27dBm eirp (68.3dBuV/m @3m).

Run #3a: Channel #116 5580MHz - 802.11a,Chain A

Spurious Radiated Emissions:

Frequency MHz	Level dBuV/m	Pol v/h	15.209 / 15E		Detector Pk/QP/Avg	Azimuth degrees	Height meters	Comments
			Limit	Margin				
3720.060	42.4	H	54.0	-11.6	AVG	323	1.4	RB 1 MHz;VB 10 Hz;Pk
3720.090	48.2	H	74.0	-25.8	PK	323	1.4	RB 1 MHz;VB 3 MHz;Pk
1306.530	38.8	V	54.0	-15.2	AVG	191	1.0	RB 1 MHz;VB 10 Hz;Pk
1306.270	42.8	V	74.0	-31.2	PK	191	1.0	RB 1 MHz;VB 3 MHz;Pk

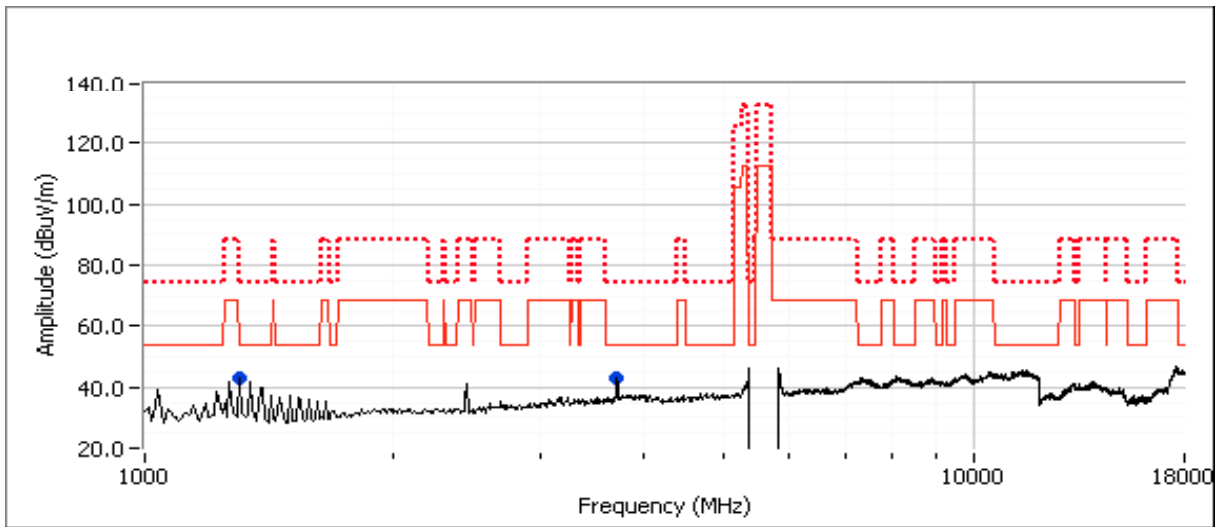

Client:	Summit Data Communications	Job Number:	J78403
Model:	SDC-MSD40NBT (1x1 802.11abg + BT 2.1)	T-Log Number:	T83196
Contact:	Ron Seide	Account Manager:	Christine Krebill
Standard:	FCC 15.E/RSS-210	Class:	N/A

Run #3b: Channel #116 5580MHz - 802.11n20, Chain A

Spurious Radiated Emissions:

Frequency MHz	Level dB μ V/m	Pol v/h	15.209 / 15E		Detector Pk/QP/Avg	Azimuth degrees	Height meters	Comments
			Limit	Margin				
3720.040	41.3	H	54.0	-12.7	AVG	46	1.0	MHz;VB 10 Hz;Pk
3720.160	47.8	H	74.0	-26.2	PK	46	1.0	MHz;VB 3 MHz;Pk
1306.560	40.8	H	54.0	-13.2	AVG	194	1.0	MHz;VB 10 Hz;Pk
1306.410	44.0	H	74.0	-30.0	PK	194	1.0	MHz;VB 3 MHz;Pk

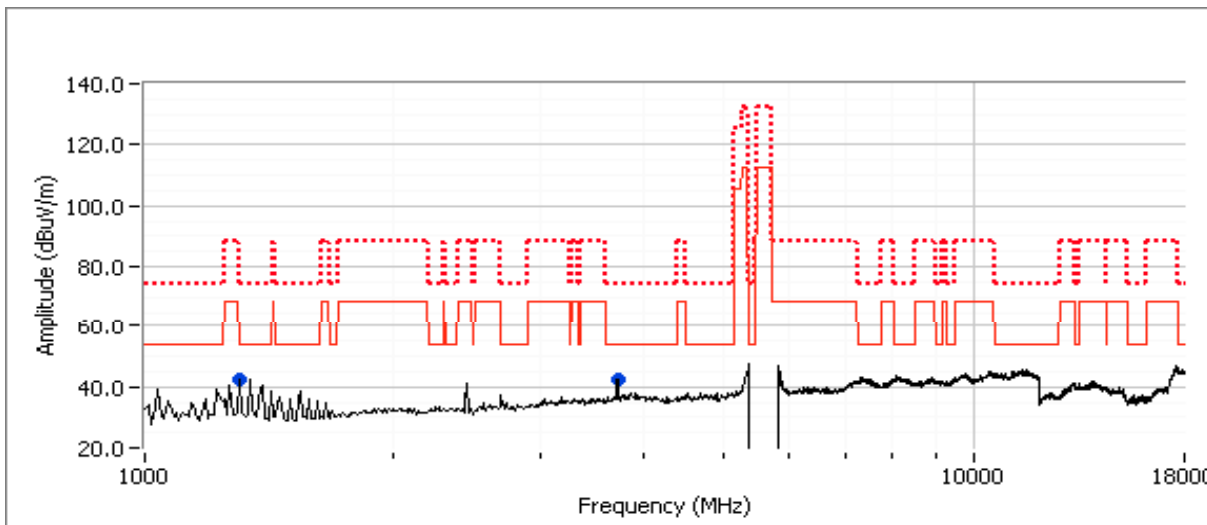

Client:	Summit Data Communications	Job Number:	J78403
Model:	SDC-MSD40NBT (1x1 802.11abg + BT 2.1)	T-Log Number:	T83196
Contact:	Ron Seide	Account Manager:	Christine Krebill
Standard:	FCC 15.E/RSS-210	Class:	N/A

Run #3c: Channel #100 5500 MHz - 802.11a

Spurious Radiated Emissions:

Frequency MHz	Level dB μ V/m	Pol v/h	15.209 / 15E		Detector Pk/QP/Avg	Azimuth degrees	Height meters	Comments
			Limit	Margin				
3666.710	42.3	H	54.0	-11.7	AVG	323	1.3	RB 1 MHz;VB 10 Hz;Pk
3666.840	48.1	H	74.0	-25.9	PK	323	1.3	RB 1 MHz;VB 3 MHz;Pk
1306.520	41.0	H	54.0	-13.0	AVG	190	1.0	RB 1 MHz;VB 10 Hz;Pk
1306.230	44.6	H	74.0	-29.4	PK	190	1.0	RB 1 MHz;VB 3 MHz;Pk

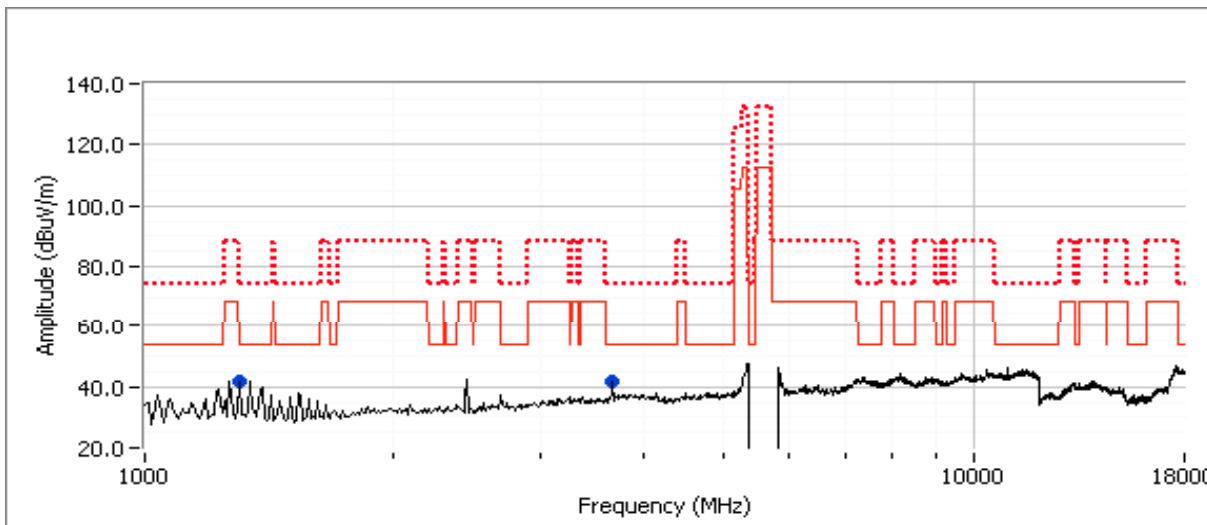

Client:	Summit Data Communications	Job Number:	J78403
Model:	SDC-MSD40NBT (1x1 802.11abg + BT 2.1)	T-Log Number:	T83196
Contact:	Ron Seide	Account Manager:	Christine Krebill
Standard:	FCC 15.E/RSS-210	Class:	N/A

Run #3d: Channel #140 5700 MHz - 802.11a

Spurious Radiated Emissions:

Frequency MHz	Level dB μ V/m	Pol v/h	15.209 / 15E		Detector Pk/QP/Avg	Azimuth degrees	Height meters	Comments
			Limit	Margin				
3800.090	41.7	H	54.0	-12.3	AVG	154	1.1	RB 1 MHz;VB 10 Hz;Pk
3799.900	47.6	H	74.0	-26.4	PK	154	1.1	RB 1 MHz;VB 3 MHz;Pk
1306.470	40.9	H	54.0	-13.1	AVG	196	1.0	RB 1 MHz;VB 10 Hz;Pk
1306.670	44.4	H	74.0	-29.6	PK	196	1.0	RB 1 MHz;VB 3 MHz;Pk

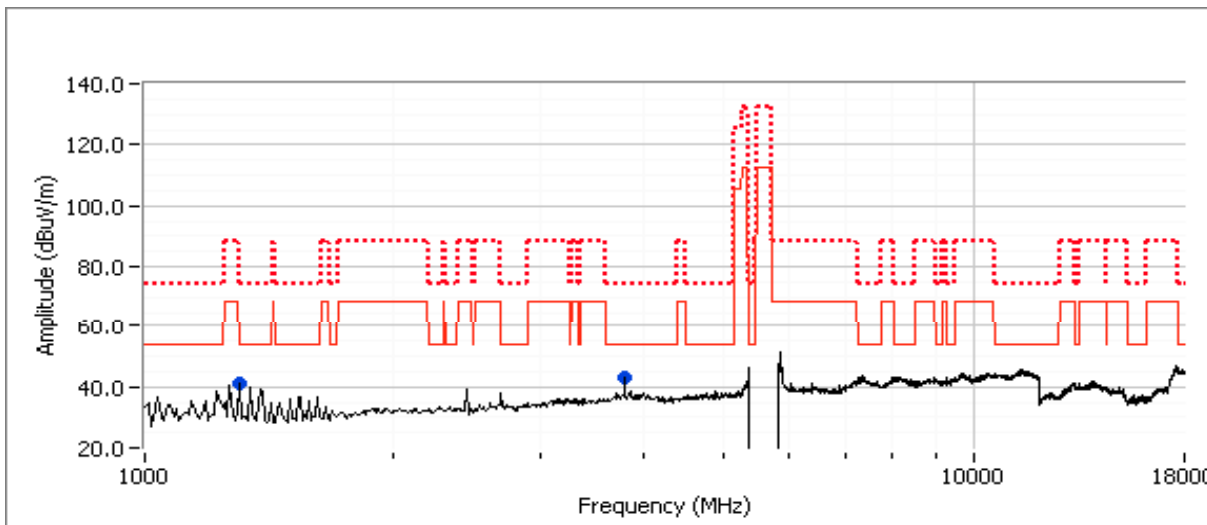

Client:	Summit Data Communications	Job Number:	J78403
Model:	SDC-MSD40NBT (1x1 802.11abg + BT 2.1)	T-Log Number:	T83196
		Account Manager:	Christine Krebill
Contact:	Ron Seide		
Standard:	FCC 15.E/RSS-210	Class:	N/A

Run #4, Radiated Spurious Emissions, 1-40GHz, Receive, Chain A

Date of Test: 1/3/2012 Test Location: FT Chamber #7
 Test Engineer: Rafael Varelas Config Change: None

For emissions in restricted bands, the limit of 15.209 was used. For all other emissions, the limit is -27dBm eirp (68.3dBuV/m @3m).

Run #4a: EUT on Channel #40 5200MHz - Receive, Chain A

Spurious Radiated Emissions:

Frequency MHz	Level dBuV/m	Pol v/h	15.209 / 15E		Detector Pk/QP/Avg	Azimuth degrees	Height meters	Comments
			Limit	Margin				
1345.470	44.5	H	54.0	-9.5	AVG	210	1.0	RB 1 MHz;VB 10 Hz;Pk
1345.390	46.8	H	74.0	-27.2	PK	210	1.0	RB 1 MHz;VB 3 MHz;Pk
1306.530	37.1	V	54.0	-16.9	AVG	252	1.1	RB 1 MHz;VB 10 Hz;Pk
1306.640	41.2	V	74.0	-32.8	PK	252	1.1	RB 1 MHz;VB 3 MHz;Pk

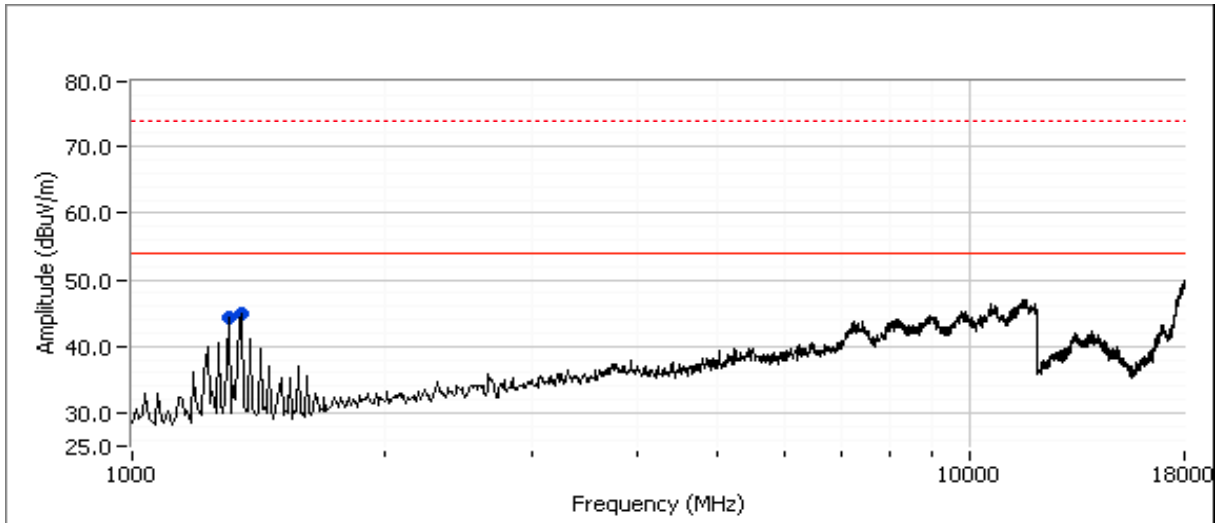

Client:	Summit Data Communications	Job Number:	J78403
Model:	SDC-MSD40NBT (1x1 802.11abg + BT 2.1)	T-Log Number:	T83196
Contact:	Ron Seide	Account Manager:	Christine Krebill
Standard:	FCC 15.E/RSS-210	Class:	N/A

Run #4b: EUT on Channel #60 5300MHz - Receive, Chain A

Spurious Radiated Emissions:

Frequency MHz	Level dB μ V/m	Pol v/h	15.209 / 15E		Detector Pk/QP/Avg	Azimuth degrees	Height meters	Comments
			Limit	Margin				
1345.480	44.4	H	54.0	-9.6	AVG	210	1.1	RB 1 MHz;VB 10 Hz;Pk
1345.490	46.7	H	74.0	-27.3	PK	210	1.1	RB 1 MHz;VB 3 MHz;Pk
1306.500	44.1	H	54.0	-9.9	AVG	203	1.0	RB 1 MHz;VB 10 Hz;Pk
1306.560	46.4	H	74.0	-27.6	PK	203	1.0	RB 1 MHz;VB 3 MHz;Pk

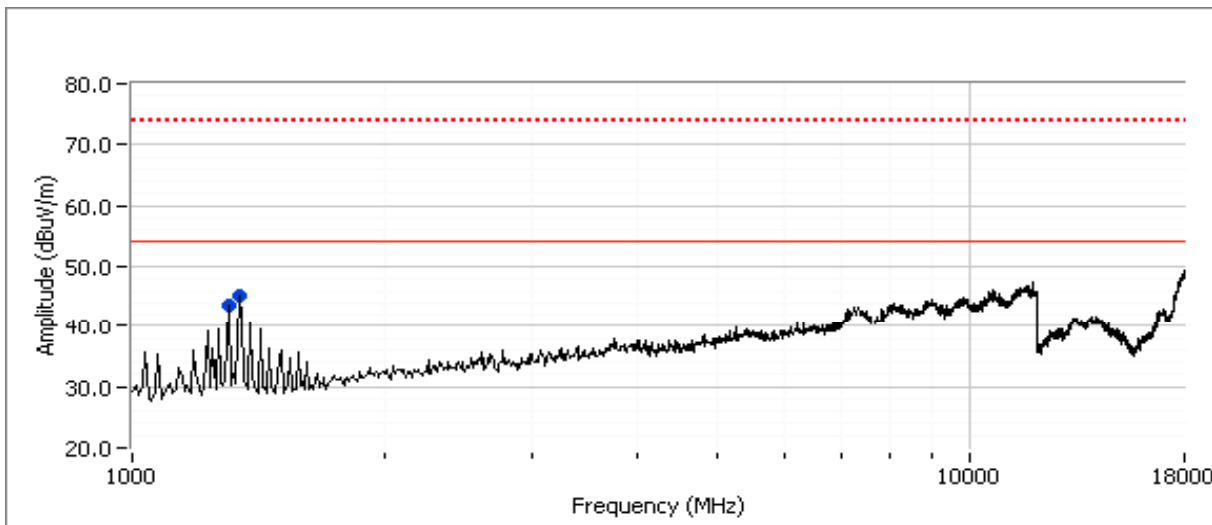

Client:	Summit Data Communications	Job Number:	J78403
Model:	SDC-MSD40NBT (1x1 802.11abg + BT 2.1)	T-Log Number:	T83196
Contact:	Ron Seide	Account Manager:	Christine Krebill
Standard:	FCC 15.E/RSS-210	Class:	N/A

Run #4c: EUT on Channel #116 5580MHz - Receive, Chain A

Spurious Radiated Emissions:

Frequency MHz	Level dB μ V/m	Pol v/h	15.209 / 15E		Detector Pk/QP/Avg	Azimuth degrees	Height meters	Comments
			Limit	Margin				
1306.480	44.1	H	54.0	-9.9	AVG	206	1.1	RB 1 MHz;VB 10 Hz;Pk
1306.480	46.1	H	74.0	-27.9	PK	206	1.1	RB 1 MHz;VB 3 MHz;Pk
1345.500	43.9	H	54.0	-10.1	AVG	212	1.0	RB 1 MHz;VB 10 Hz;Pk
1345.540	46.1	H	74.0	-27.9	PK	212	1.0	RB 1 MHz;VB 3 MHz;Pk

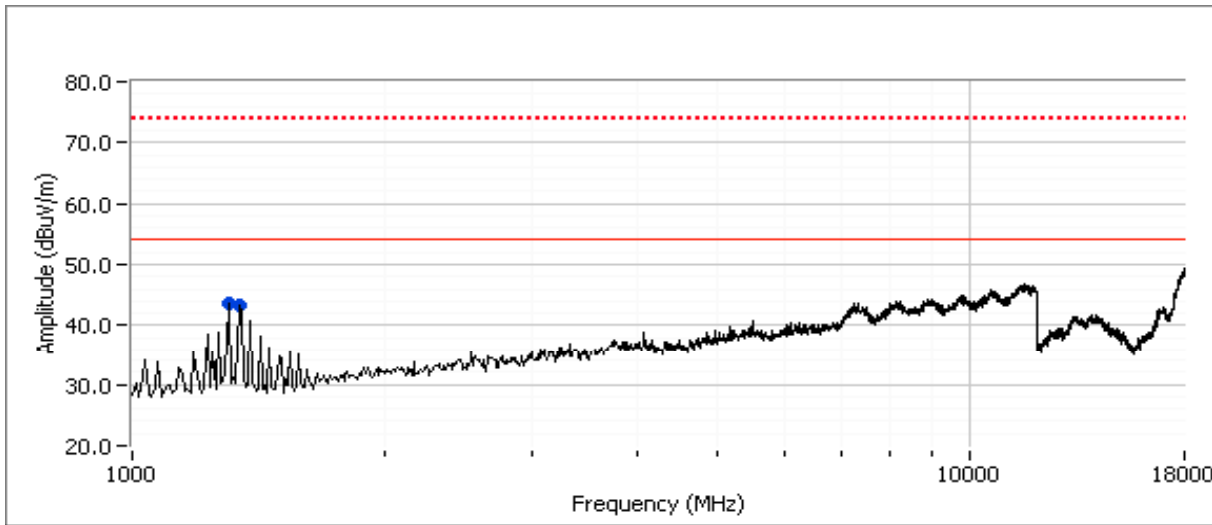

Client:	Summit Data Communications	Job Number:	J78403
Model:	SDC-MSD40NBT (1x1 802.11abg + BT 2.1)	T-Log Number:	T83196
		Account Manager:	Christine Krebill
Contact:	Ron Seide		
Standard:	FCC 15.E/RSS-210	Class:	N/A

**RSS-210 (LELAN) and FCC 15.407(UNII)
Antenna Port Measurements
Power, PSD, Peak Excursion, Bandwidth and Spurious Emissions**

Test Specific Details

Objective: The objective of this test session is to perform final qualification testing of the EUT with respect to the specification listed above.

Date of Test: 8/24/2011 0:00	Config. Used: 2
Test Engineer: John Caizzi / Joseph Cadigal	Config Change: no antennas
Test Location: FT5	EUT Voltage: 3.3 VDC

Summary of Results

New Module #2011-1296, Laptop #2011-2312, Linux Shell

Run #	Test Performed	Limit	Pass / Fail	Result / Margin
1	Power, 5150 - 5250MHz	15.407(a) (1), (2)	Pass	802.11a: 12 mW 802.11n20: 9 mW
1	PSD, 5150 - 5250MHz	15.407(a) (1), (2)	Pass	802.11a: 0.3 dBm/MHz 802.11n 20MHz: -1.8 dBm/MHz
1	Power, 5250 - 5350MHz	15.407(a) (1), (2)	Pass	802.11a: 26 mW 802.11n 20MHz: 21 mW
1	PSD, 5250 - 5350MHz	15.407(a) (1), (2)	Pass	802.11a: 3.1 dBm/MHz 802.11n 20MHz: 1.7 dBm/MHz
1	Max EIRP 5250 - 5350MHz	TPC required if EIRP ≥ 500mW (27dBm). EIRP ≥ 200mW (23dBm) DFS threshold = -64dBm	N/A	EIRP = 20.7 dBm (116.1 mW) TPC not required
1	Power, 5470 - 5725MHz	15.407(a) (1), (2)	Pass	802.11a: 31.6 mW 802.11n 20MHz: 21 mW
1	PSD, 5470 - 5725MHz	15.407(a) (1), (2)	Pass	802.11a: 4 dBm/MHz 802.11n 20MHz: 3.2 dBm/MHz
1	Max EIRP 5470 - 5725MHz	TPC required if EIRP ≥ 500mW (27dBm). EIRP ≥ 200mW (23dBm) DFS threshold = -64dBm.	N/A	EIRP = 21.5 dBm (140 mW) TPC not required

Client:	Summit Data Communications	Job Number:	J78403
Model:	SDC-MSD40NBT (1x1 802.11abg + BT 2.1)	T-Log Number:	T83196
		Account Manager:	Christine Krebill
Contact:	Ron Seide		
Standard:	FCC 15.E/RSS-210	Class:	N/A

Run #	Test Performed	Limit	Pass / Fail	Result / Margin
1	26dB Bandwidth	15.407 (Information only)	-	> 20MHz for all modes
1	99% Bandwidth	RSS 210 (Information only)	N/A	802.11a: 17.2 MHz 802.11n 20MHz: 18 MHz
2	Peak Excursion Envelope	15.407(a) (6) 13dB	-	802.11a: Pass 802.11n 20MHz: Pass
3	Antenna Conducted - Out of Band Spurious	15.407(b) -27dBm/MHz	Pass	All emissions below the -27dBm/MHz limit

General Test Configuration

When measuring the conducted emissions from the EUT's antenna port, the antenna port of the EUT was connected to the spectrum analyzer or power meter via a suitable attenuator to prevent overloading the measurement system. All measurements are corrected to allow for the external attenuators and cables used.

Ambient Conditions:

Temperature: 24 °C
Rel. Humidity: 43 %

Modifications Made During Testing

No modifications were made to the EUT during testing

Deviations From The Standard

No deviations were made from the requirements of the standard.

Client:	Summit Data Communications	Job Number:	J78403
Model:	SDC-MSD40NBT (1x1 802.11abg + BT 2.1)	T-Log Number:	T83196
		Account Manager:	Christine Krebill
Contact:	Ron Seide		
Standard:	FCC 15.E/RSS-210	Class:	N/A

Run #1: Bandwidth, Output Power and Power Spectral Density - Single Chain Systems

Note 1:	Output power measured using a spectrum analyzer (see plots below). RBW=1MHz, VB=3 MHz, sample detector, power averaging on (transmitted signal was not continuous but the analyzer was configured with a gated sweep such that it was sweeping only when the device was transmitting) and power integration over 50 MHz (method 1 of DA-02-2138A1).
Note 2:	Measured using the same analyzer settings used for output power.
Note 3:	For RSS-210 the limit for the 5150 - 5250 MHz band accounts for the antenna gain as the maximum eirp allowed is 10dBm/MHz. The limits are also corrected for instances where the highest measured value of the PSD exceeds the average PSD (calculated from the measured power divided by the measured 99% bandwidth) by more than 3dB by the amount that the measured value exceeds the average by more than 3dB.
Note 4:	99% Bandwidth measured in accordance with RSS GEN - RB > 1% of span and VB >=3xRB

Single Chain Operation, 5150-5250MHz Band

Antenna Gain (dBi): 5 EIRP: 37.6 mW 15.8 dBm

Frequency (MHz)	Software Setting	Bandwidth		Output Power ¹ dBm		Power (Watts)	PSD ² dBm/MHz			Result
		26dB	99% ⁴	Measured	Limit		Measured	FCC Limit	RSS Limit ³	
802.11a										
5180	Default	33.7	16.9	9.8	17.0	0.010	-1.2	4.0	5.0	Pass
5200		27.8	16.9	10.0	17.0	0.010	-1.0	4.0	5.0	Pass
5240		30.2	16.9	10.8	17.0	0.012	0.3	4.0	5.0	Pass
802.11n 20MHz										
5180	Default	28.9	18.0	8.6	17.0	0.007	-2.9	4.0	5.0	Pass
5200		29.0	18.0	8.9	17.0	0.008	-2.4	4.0	5.0	Pass
5240		26.3	18.0	9.7	17.0	0.009	-1.8	4.0	5.0	Pass

Measured with peak power meter for reference purposes only

802.11a										
5180	Default	33.7	16.9	19.3	17.0	0.085	-	-	-	-
5200		27.8	16.9	19.5	17.0	0.089	-	-	-	-
5240		30.2	16.9	19.8	17.0	0.095	-	-	-	-
802.11n 20MHz										
5180	Default	28.9	18.0	18.8	17.0	0.076	-	-	-	-
5200		29.0	18.0	18.9	17.0	0.078	-	-	-	-
5240		26.3	18.0	19.3	17.0	0.085	-	-	-	-

Client: Summit Data Communications	Job Number: J78403
Model: SDC-MSD40NBT (1x1 802.11abg + BT 2.1)	T-Log Number: T83196
	Account Manager: Christine Krebill
Contact: Ron Seide	
Standard: FCC 15.E/RSS-210	Class: N/A

Single Chain Operation, 5250-5350 MHz Band

Antenna Gain (dBi): **5** EIRP: **82.2 mW** **19.2 dBm**

Frequency (MHz)	Software Setting	Bandwidth		Output Power ¹ dBm		Power (Watts)	PSD ² dBm/MHz			Result
		26dB	99% ⁴	Measured	Limit		Measured	FCC Limit	RSS Limit ³	
802.11a										
5260	-	29.7	17.1	12.8	24.0	0.019	1.6	11.0	11.0	Pass
5300	-	33.7	17.3	14.2	24.0	0.026	3.1	11.0	11.0	Pass
5320	-	23.3	16.7	10.5	24.0	0.011	-0.7	11.0	11.0	Pass
802.11n 20MHz										
5260	-	29.7	18.1	11.9	24.0	0.016	0.4	11.0	11.0	Pass
5300	-	32.8	18.1	13.2	24.0	0.021	1.7	11.0	11.0	Pass
5320	-	22.2	17.9	8.5	24.0	0.007	-2.8	11.0	11.0	Pass

Measured with peak power meter for reference purposes only

802.11a										
5260	-	29.7	17.1	19.9	24.0	0.098	-	-	-	-
5300	-	33.7	17.3	19.5	24.0	0.089	-	-	-	-
5320	-	23.3	16.7		24.0	0.001	-	-	-	-
802.11n 20MHz										
5260	-	29.7	18.1	19.2	24.0	0.083	-	-	-	-
5300	-	32.8	18.1	19.1	24.0	0.081	-	-	-	-
5320	-	22.2	17.9		24.0	0.001	-	-	-	-

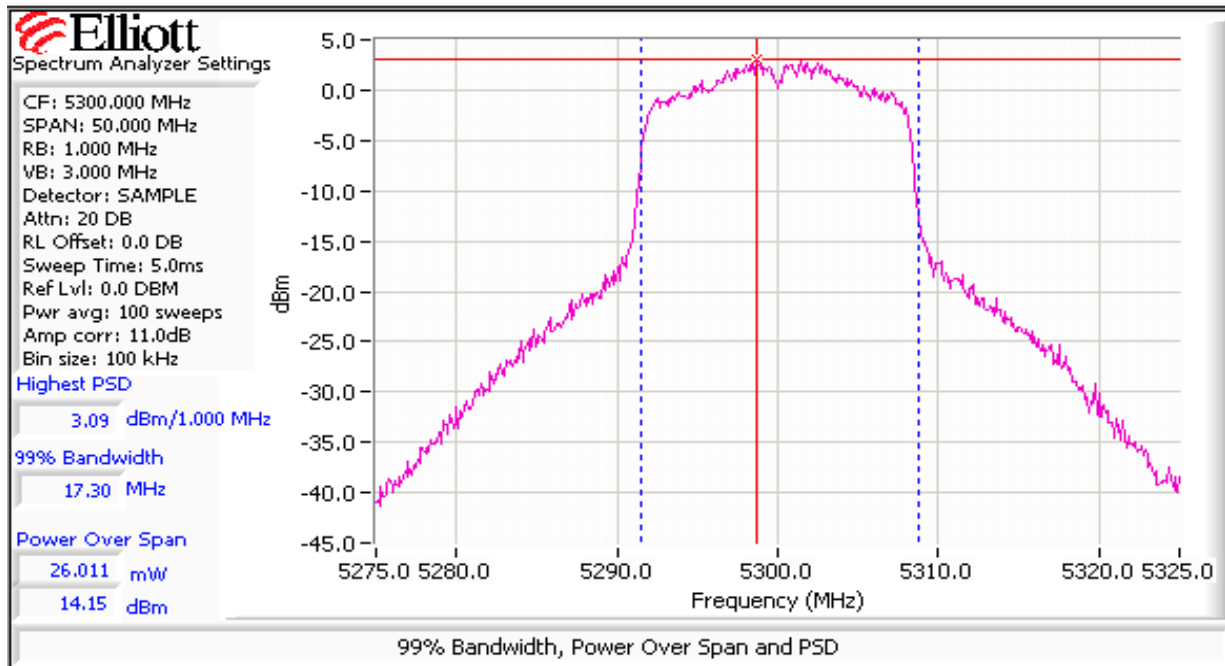

Client:	Summit Data Communications	Job Number:	J78403
Model:	SDC-MSD40NBT (1x1 802.11abg + BT 2.1)	T-Log Number:	T83196
		Account Manager:	Christine Krebill
Contact:	Ron Seide		
Standard:	FCC 15.E/RSS-210	Class:	N/A

Single Chain Operation, 5470- 5725 MHz Band

Antenna Gain (dBi): 5 EIRP: 99.1 mW 20.0 dBm

Frequency (MHz)	Software Setting	Bandwidth		Output Power ¹ dBm		Power (Watts)	PSD ² dBm/MHz			Result
		26dB	99% ⁴	Measured	Limit		Measured	FCC Limit	RSS Limit ³	
802.11a										
5500	Default	31.5	17.2	15.0	24.0	0.031	4.0	11.0	11.0	Pass
5580		30.5	16.9	13.5	24.0	0.022	2.4	11.0	11.0	Pass
5700		25.5	16.6	8.1	24.0	0.006	-2.9	11.0	11.0	Pass
802.11n 20MHz										
5500	Default	29.5	17.9	13.2	24.0	0.021	2.1	11.0	11.0	Pass
5580		28.2	18.0	12.6	24.0	0.018	1.5	11.0	11.0	Pass
5700		29.3	18.0	10.7	24.0	0.012	-0.7	11.0	11.0	Pass

Measured with peak power meter for reference purposes only

802.11a										
5500	Default	31.5	17.2	17.5	24.0	0.056	-	-	-	-
5580		29.3	16.9	16.5	24.0	0.045	-	-	-	-
5700		22.3	16.6	12.4	24.0	0.017	-	-	-	-
802.11n 20MHz										
5500	Default	29.5	17.9	17.1	24.0	0.051	-	-	-	-
5580		28.2	18.0	15.8	24.0	0.038	-	-	-	-
5700		29.3	18.0	14.7	24.0	0.030	-	-	-	-

Taiwan LP0002 Power Table (Copied data from FCC table above, which also passes Taiwan limits.)

Single Chain Operation, 5250-5350 MHz Band, LP0002 (Taiwan)

Antenna Gain (dBi): 6.5 EIRP: 117.5 mW 20.7 dBm

Frequency (MHz)	Software Setting	Bandwidth		Output Power ¹ dBm		Power (Watts)	PSD ² dBm/MHz		Result	
		26dB	99% ⁴	Measured	Limit		Measured	LP0002 Limit		
802.11a										
5260	-	29.7	17.1	12.8	16.5	0.019	1.6	3.5	Pass	
5300	-	33.7	17.3	14.2	16.5	0.026	3.1	3.5	Pass	
5320	-	23.3	16.7	10.5	16.5	0.011	-0.7	3.5	Pass	
802.11n 20MHz										
5260	-	29.7	18.1	11.9	16.5	0.015	0.4	3.5	Pass	
5300	-	32.8	18.1	13.2	16.5	0.021	1.7	3.5	Pass	
5320	-	22.2	17.9	8.5	16.5	0.007	-2.8	3.5	Pass	

Client:	Summit Data Communications	Job Number:	J78403
Model:	SDC-MSD40NBT (1x1 802.11abg + BT 2.1)	T-Log Number:	T83196
		Account Manager:	Christine Krebill
Contact:	Ron Seide		
Standard:	FCC 15.E/RSS-210	Class:	N/A

(802.11n20) 20MHz: Device meets the requirement for the peak excursion

Peak Excursion(dB)			Peak Excursion(dB)			Peak Excursion(dB)		
Freq (MHz)	Value	Limit	Freq (MHz)	Value	Limit	Freq (MHz)	Value	Limit
5180	12.1	13.0	5260	11.2	13.0	5500	11.8	13.0
5200	11.6	13.0	5300	11.7	13.0	5580	11.2	13.0
5240	11.4	13.0	5320	11.8	13.0	5700	11.8	13.0

Client: Summit Data Communications	Job Number: J78403
Model: SDC-MSD40NBT (1x1 802.11abg + BT 2.1)	T-Log Number: T83196
	Account Manager: Christine Krebill
Contact: Ron Seide	
Standard: FCC 15.E/RSS-210	Class: N/A

Plots Showing Peak Excursion

Trace A: RBW = 1MHz, VBW = 3MHz, Peak hold

Trace B: Same settings as used for power/PSD measurements (RBW = 1 MHz, VBW = 3MHz, Integrated average power)

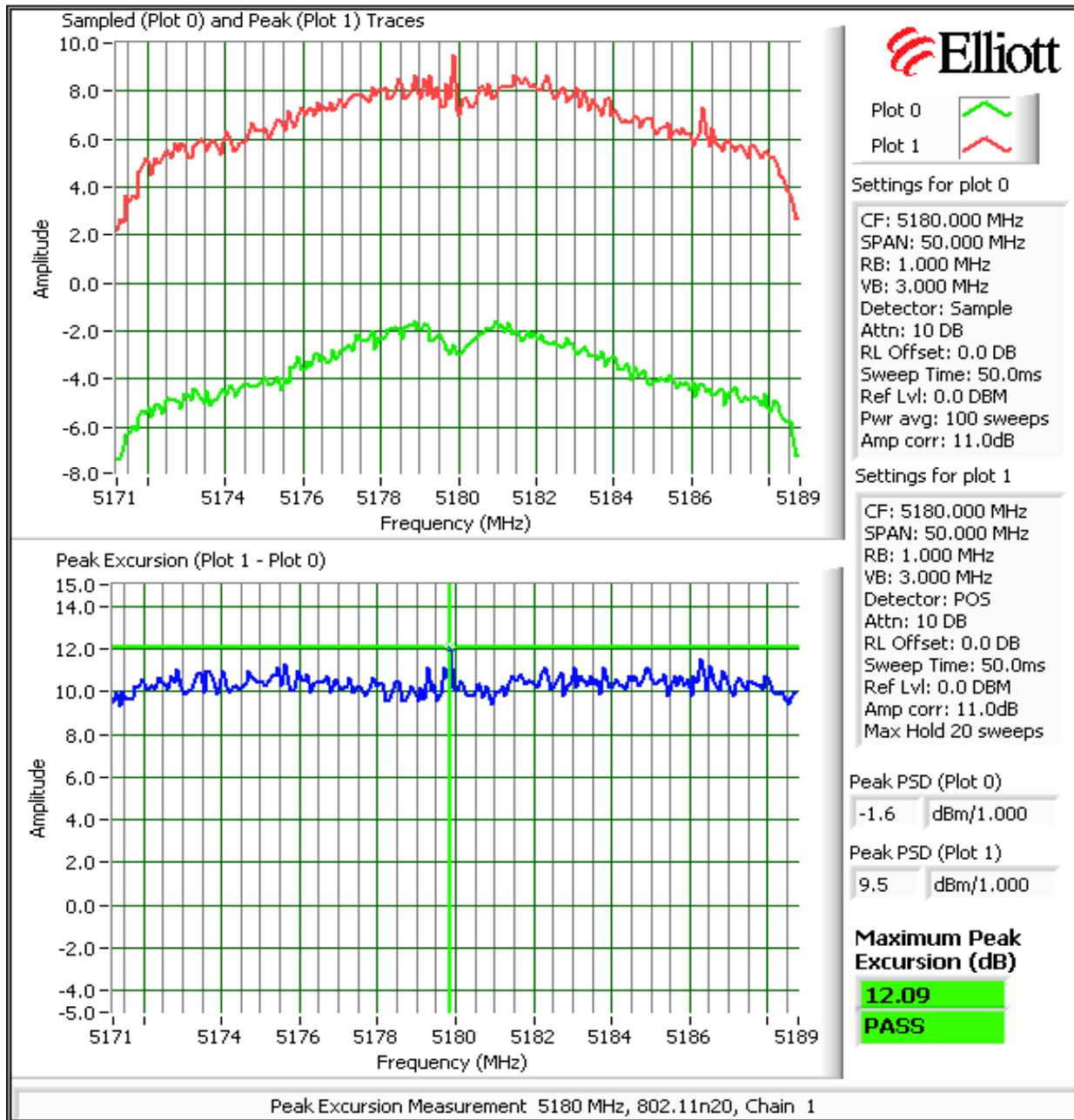

Client:	Summit Data Communications	Job Number:	J78403
Model:	SDC-MSD40NBT (1x1 802.11abg + BT 2.1)	T-Log Number:	T83196
		Account Manager:	Christine Krebill
Contact:	Ron Seide		
Standard:	FCC 15.E/RSS-210	Class:	N/A

Run #3: Out Of Band Spurious Emissions - Antenna Conducted

Maximum Antenna Gain: 6.5 dBi
 Spurious Limit: -27.0 dBm/MHz eirp
 Limit Used On Plots ^{Note 1}: -33.5 dBm/MHz Average Limit (RB=1MHz, VB=10Hz)
 -13.5 dBm/MHz Peak Limit (RB=VB=1MHz)

- Note 1: The -27dBm/MHz limit is an eirp limit. The limit for antenna port conducted measurements is adjusted to take into consideration the maximum antenna gain (limit = -27dBm - antenna gain). Radiated field strength measurements for signals more than 50MHz from the bands and that are close to the limit are made to determine compliance as the antenna gain is not known at these frequencies.
- Note 2: All spurious signals below 1GHz are measured during digital device radiated emissions test.
- Note 3: Signals within 10MHz of the 5.725 or 5.825 Band edge are subject to a limit of -17dBm EIRP
- Note 4: If the device is for outdoor use then the -27dBm eirp limit also applies in the 5150 - 5250 MHz band.
- Note 5: Signals that fall in the restricted bands of 15.205 are subject to the limit of 15.209.

Plots Showing Out-Of-Band Emissions (RBW=VBW=1MHz)

802.11a

Low channel, 5150 - 5250 MHz Band

Compliance with the radiated limits for the restricted band immediately below 5150MHz is demonstrated through the radiated emissions tests.

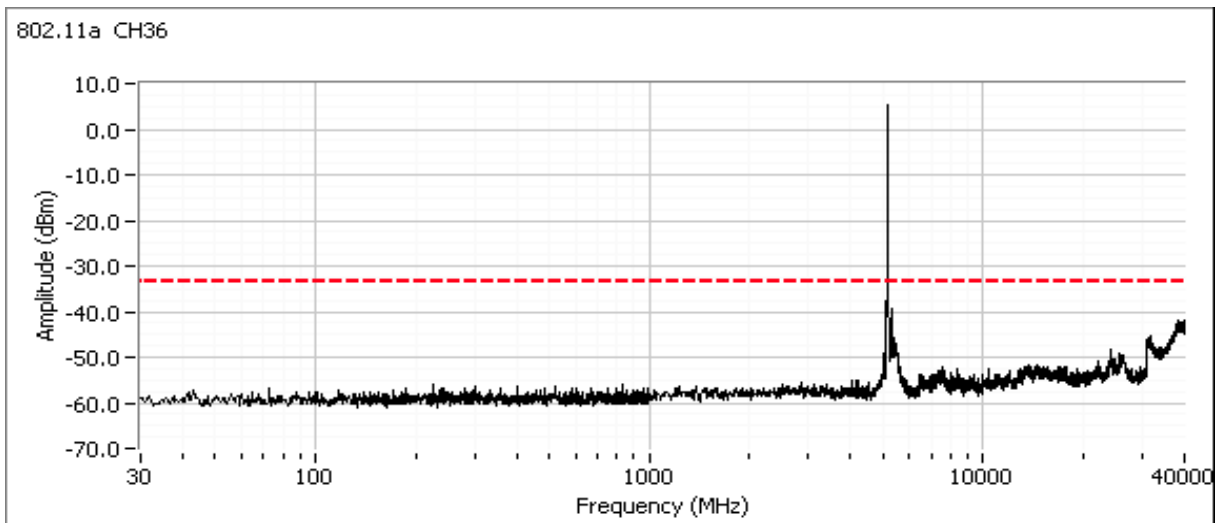

Client: Summit Data Communications	Job Number: J78403
Model: SDC-MSD40NBT (1x1 802.11abg + BT 2.1)	T-Log Number: T83196
	Account Manager: Christine Krebill
Contact: Ron Seide	
Standard: FCC 15.E/RSS-210	Class: N/A

Center channel, 5150 - 5250 MHz Band

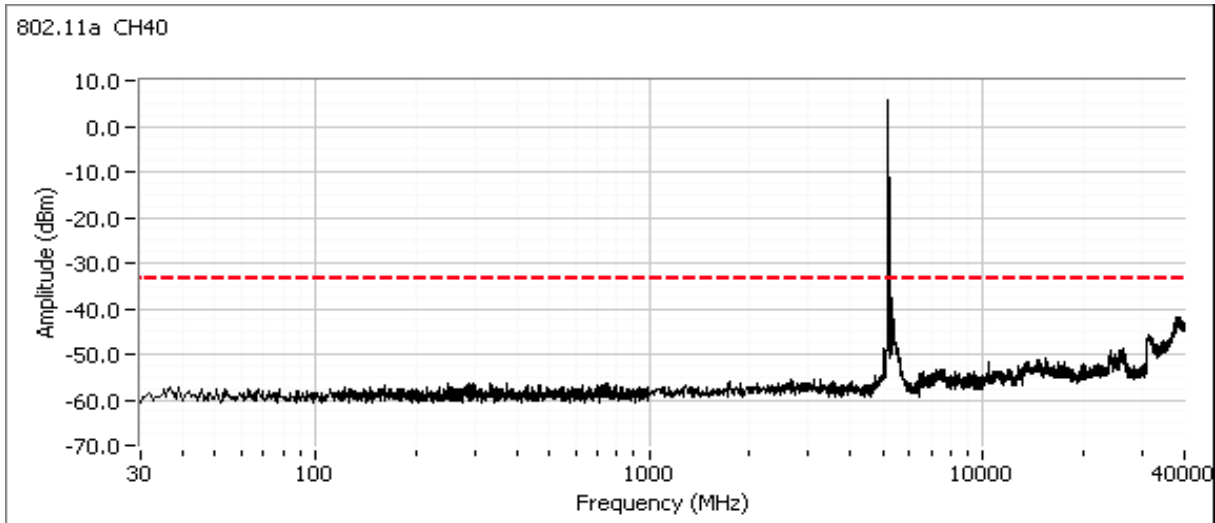

High channel, 5150 - 5250 MHz Band

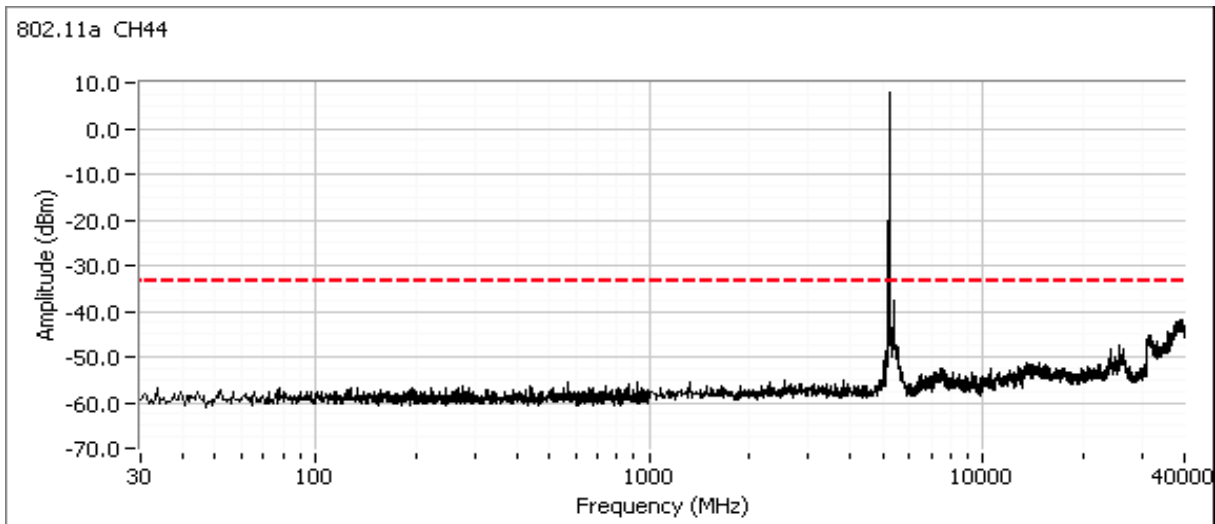

Client: Summit Data Communications	Job Number: J78403
Model: SDC-MSD40NBT (1x1 802.11abg + BT 2.1)	T-Log Number: T83196
	Account Manager: Christine Krebill
Contact: Ron Seide	
Standard: FCC 15.E/RSS-210	Class: N/A

Low channel, 5250 - 5350 MHz Band

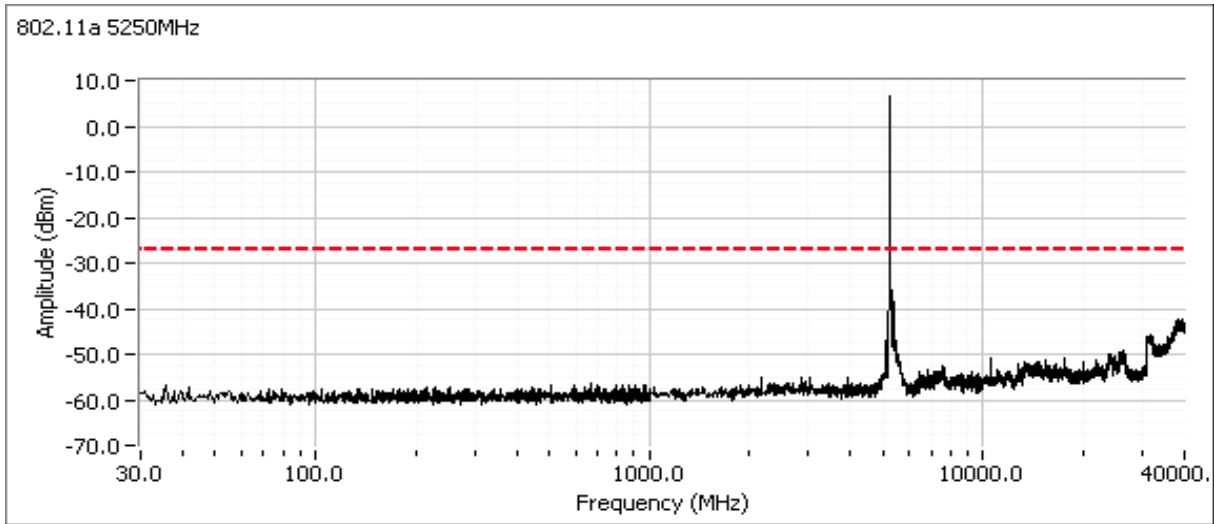

Center channel, 5250 - 5350 MHz Band

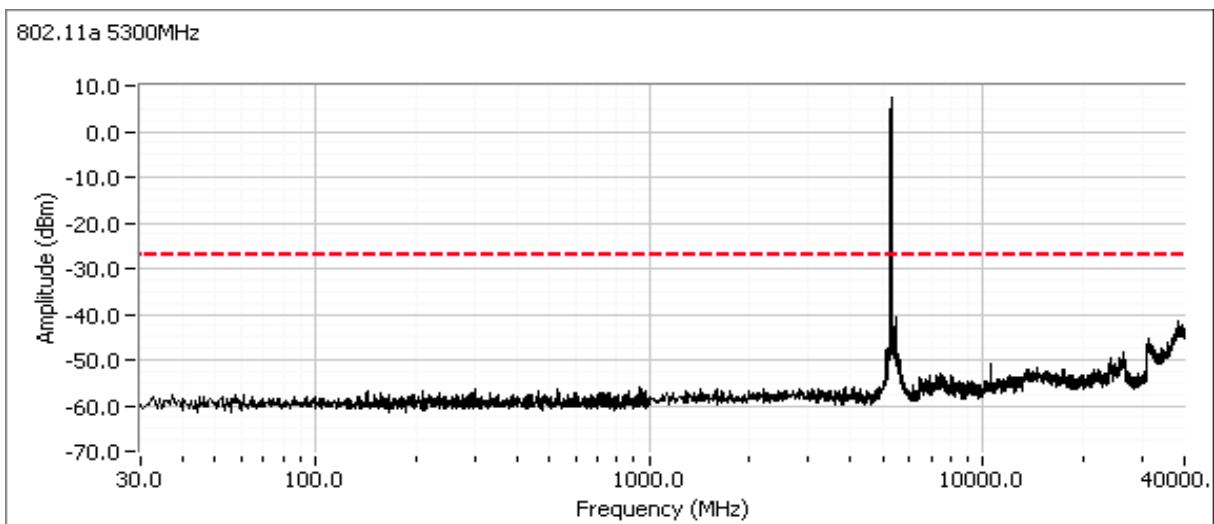

Client:	Summit Data Communications	Job Number:	J78403
Model:	SDC-MSD40NBT (1x1 802.11abg + BT 2.1)	T-Log Number:	T83196
		Account Manager:	Christine Krebill
Contact:	Ron Seide		
Standard:	FCC 15.E/RSS-210	Class:	N/A

High channel, 5250 - 5350 MHz Band

Compliance with the radiated limits for the restricted band immediately above 5350MHz is demonstrated through the radiated emissions tests.

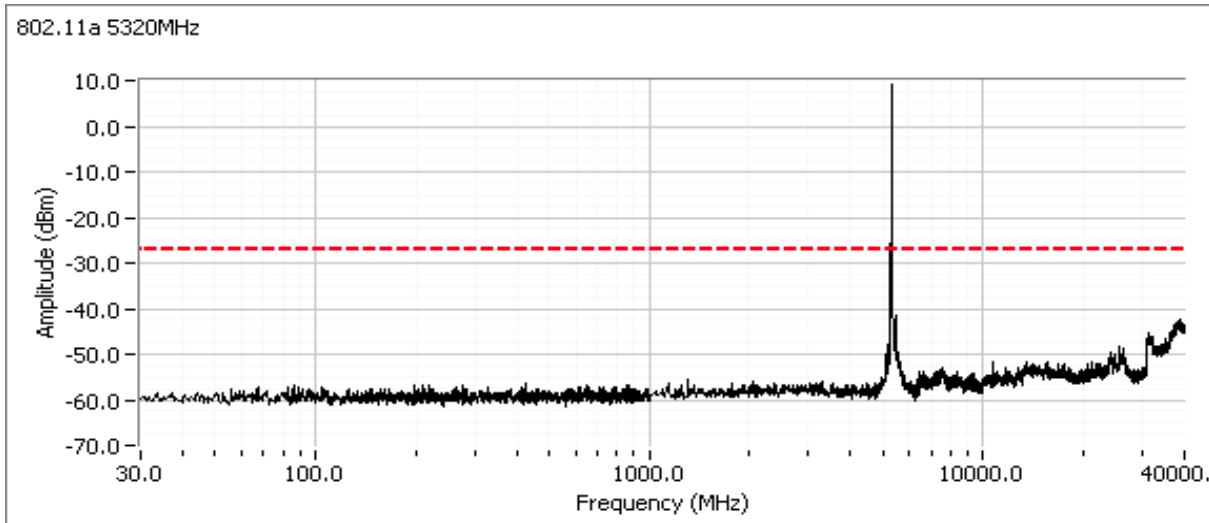

Low channel, 5470 - 5725 MHz Band

Includes a plot from 5460 - 5470 MHz showing compliance with the limit immediately below the allocated band from 5460-5470 MHz. Compliance with the radiated limits for the restricted band below 5460 MHz is demonstrated through the radiated emissions tests.

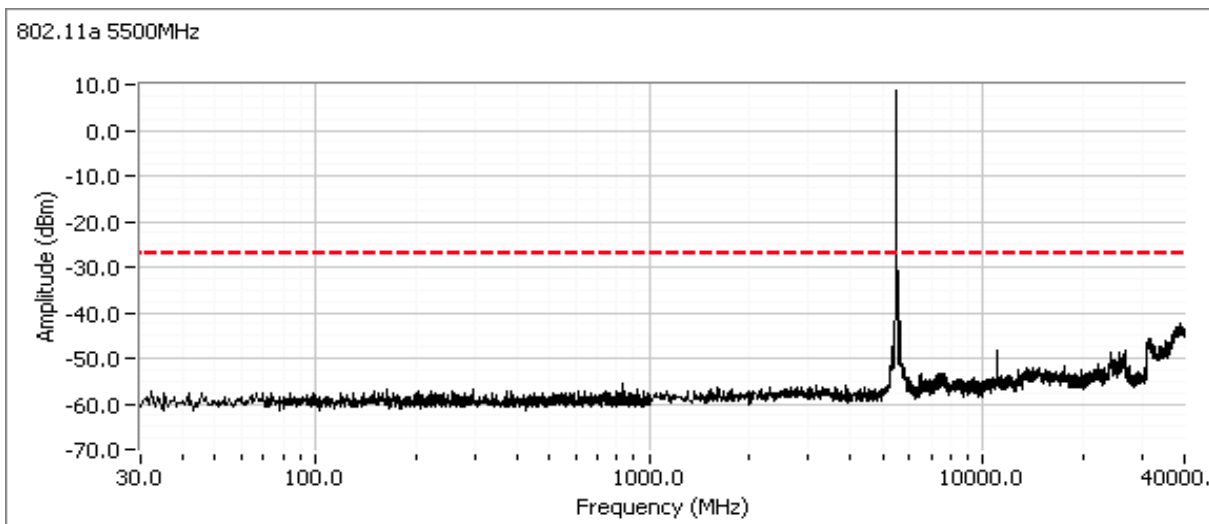

Client: Summit Data Communications	Job Number: J78403
Model: SDC-MSD40NBT (1x1 802.11abg + BT 2.1)	T-Log Number: T83196
	Account Manager: Christine Krebill
Contact: Ron Seide	
Standard: FCC 15.E/RSS-210	Class: N/A

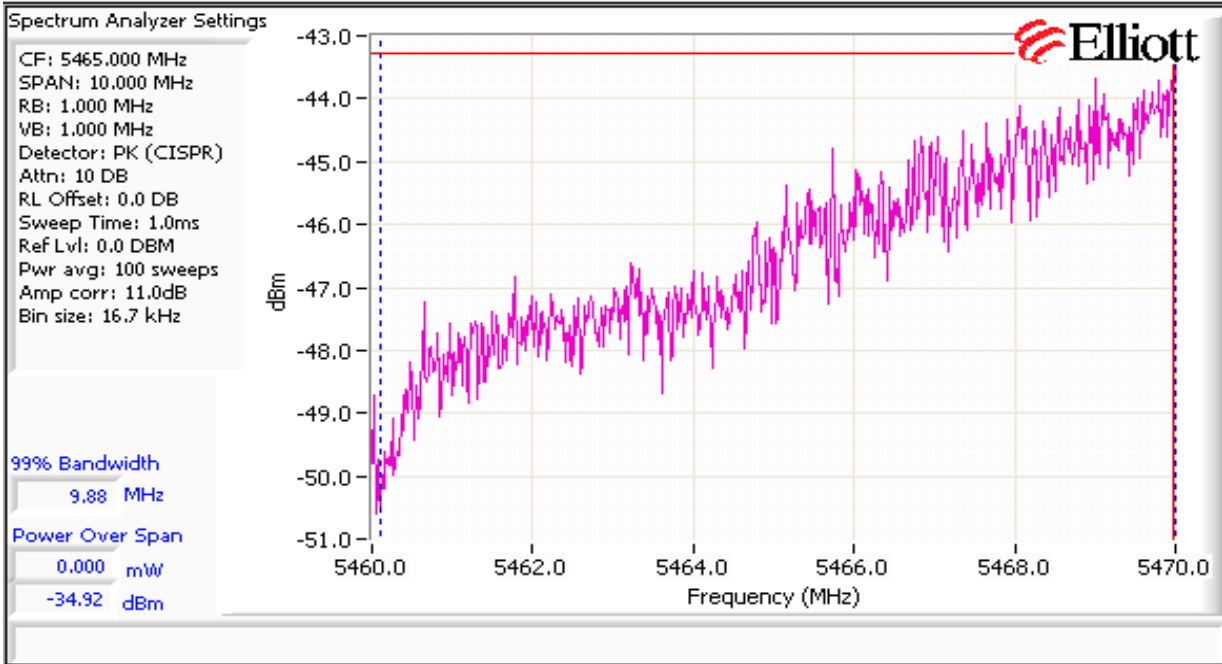

Client:	Summit Data Communications	Job Number:	J78403
Model:	SDC-MSD40NBT (1x1 802.11abg + BT 2.1)	T-Log Number:	T83196
		Account Manager:	Christine Krebill
Contact:	Ron Seide		
Standard:	FCC 15.E/RSS-210	Class:	N/A

Center channel, 5470 - 5725 MHz Band (20Mhz channel use 5580 MHz, 40MHz channel use 5550 MHz)

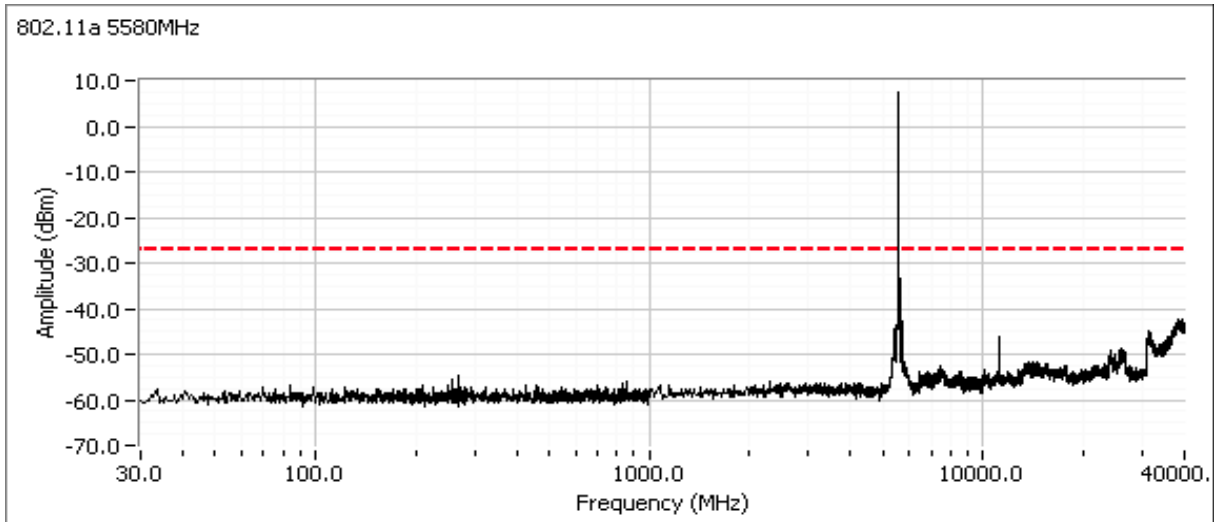

Client: Summit Data Communications	Job Number: J78403
Model: SDC-MSD40NBT (1x1 802.11abg + BT 2.1)	T-Log Number: T83196
	Account Manager: Christine Krebill
Contact: Ron Seide	
Standard: FCC 15.E/RSS-210	Class: N/A

High channel, 5470 - 5725 MHz Band

Includes a plot from 5725 - 5780 MHz showing compliance with the -27dBm/MHz eirp limit immediately above the allocated band (5725 MHz).

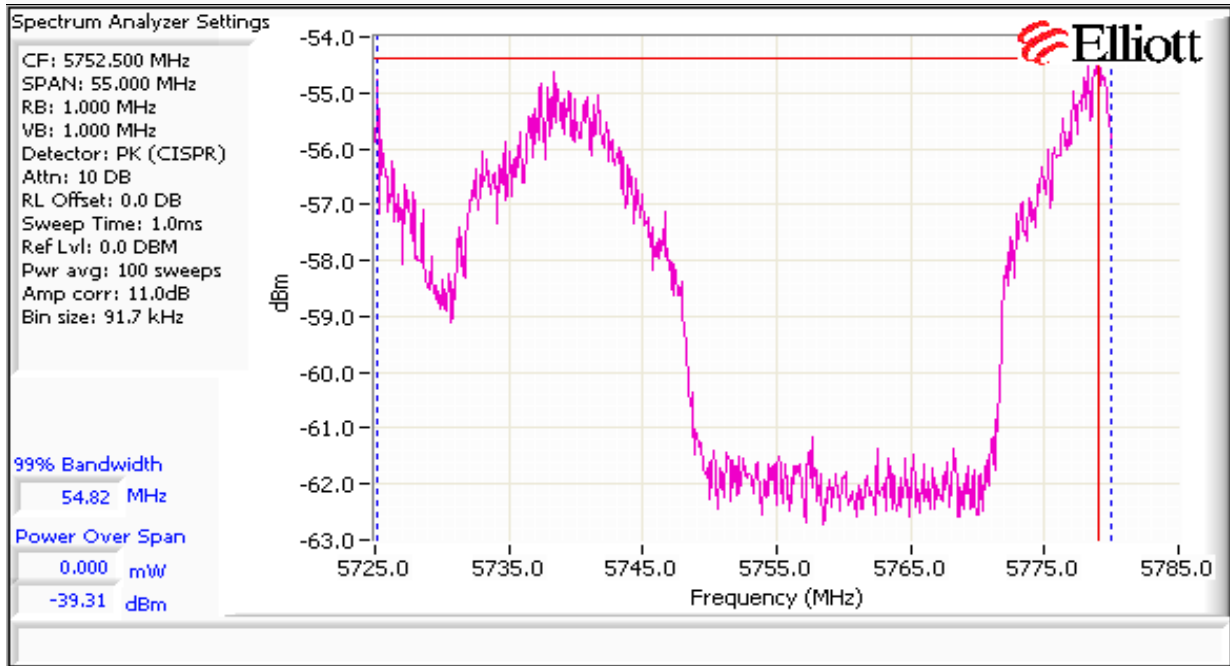
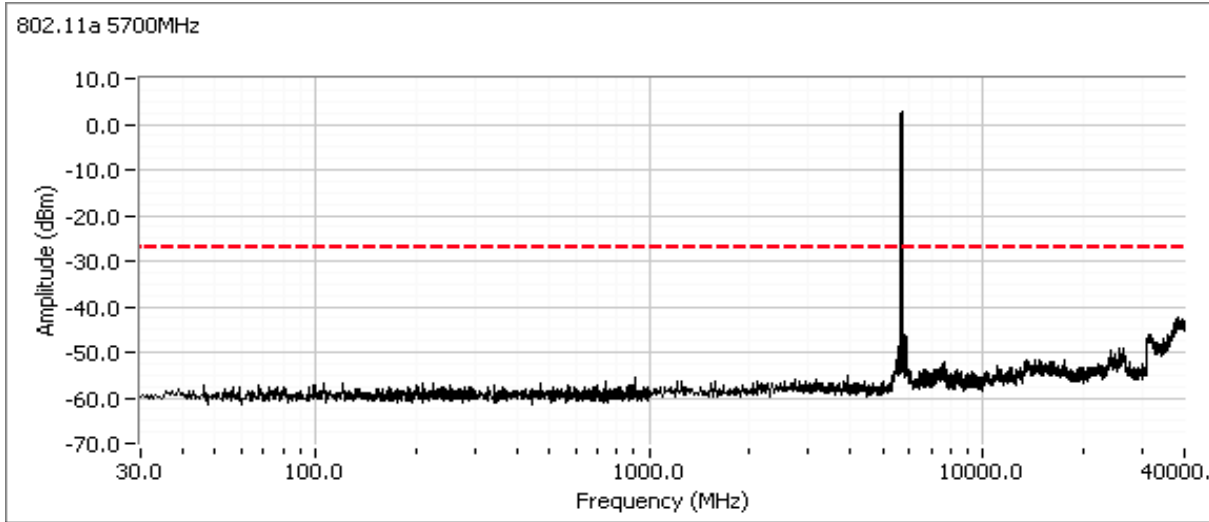

Client:	Summit Data Communications	Job Number:	J78403
Model:	SDC-MSD40NBT (1x1 802.11abg + BT 2.1)	T-Log Number:	T83196
		Account Manager:	Christine Krebill
Contact:	Ron Seide		
Standard:	FCC 15.E/RSS-210	Class:	N/A

802.11n20

Low channel, 5150 - 5250 MHz Band

Compliance with the radiated limits for the restricted band immediately below 5150MHz is demonstrated through the radiated emissions tests.

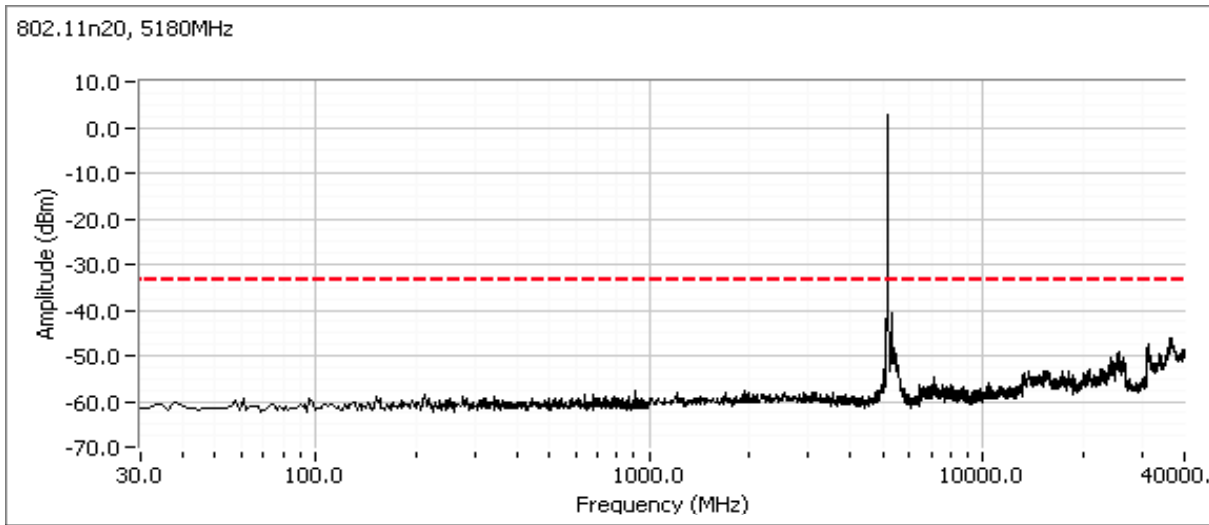

Center channel, 5150 - 5250 MHz Band

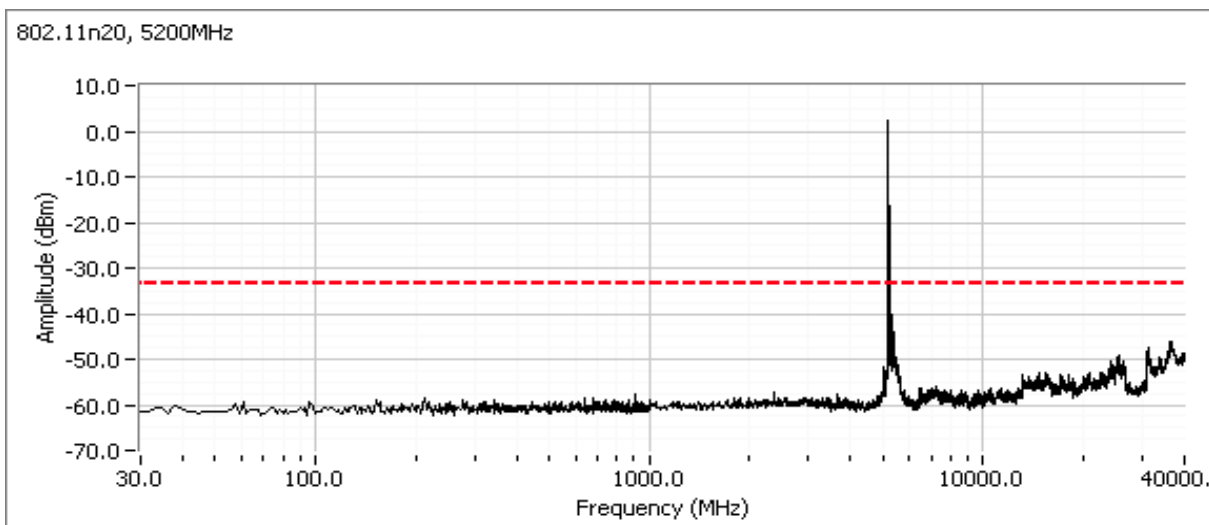

Client: Summit Data Communications	Job Number: J78403
Model: SDC-MSD40NBT (1x1 802.11abg + BT 2.1)	T-Log Number: T83196
	Account Manager: Christine Krebill
Contact: Ron Seide	
Standard: FCC 15.E/RSS-210	Class: N/A

High channel, 5150 - 5250 MHz Band

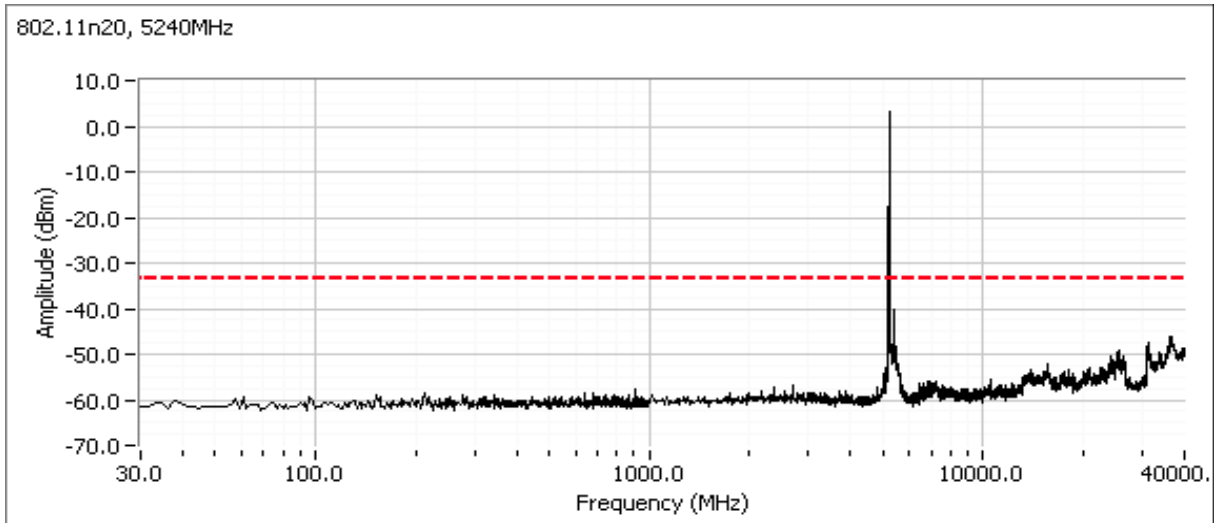

Low channel, 5250 - 5350 MHz Band

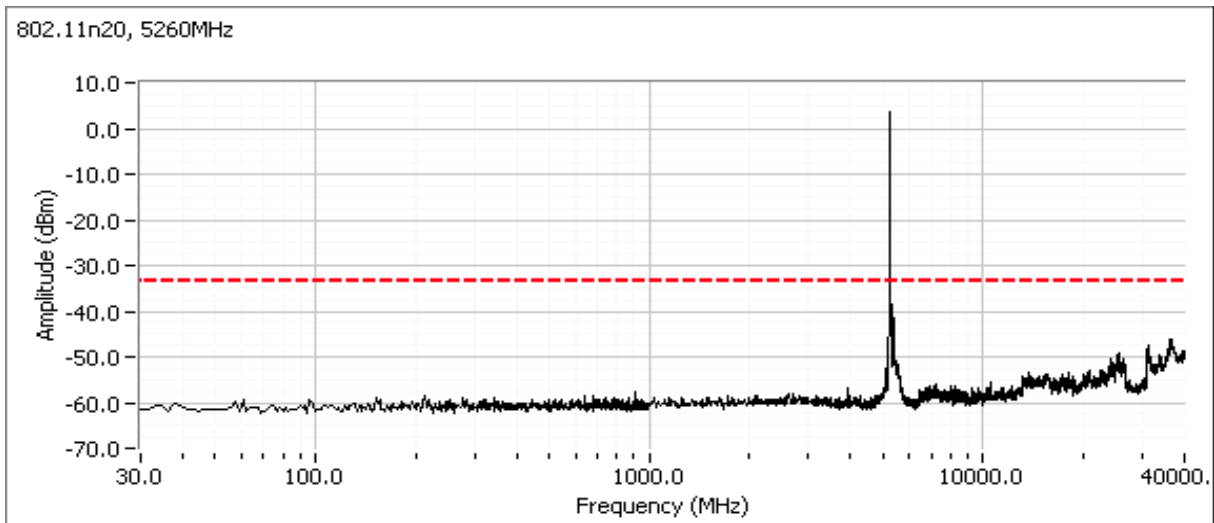

Client: Summit Data Communications	Job Number: J78403
Model: SDC-MSD40NBT (1x1 802.11abg + BT 2.1)	T-Log Number: T83196
	Account Manager: Christine Krebill
Contact: Ron Seide	
Standard: FCC 15.E/RSS-210	Class: N/A

Center channel, 5250 - 5350 MHz Band

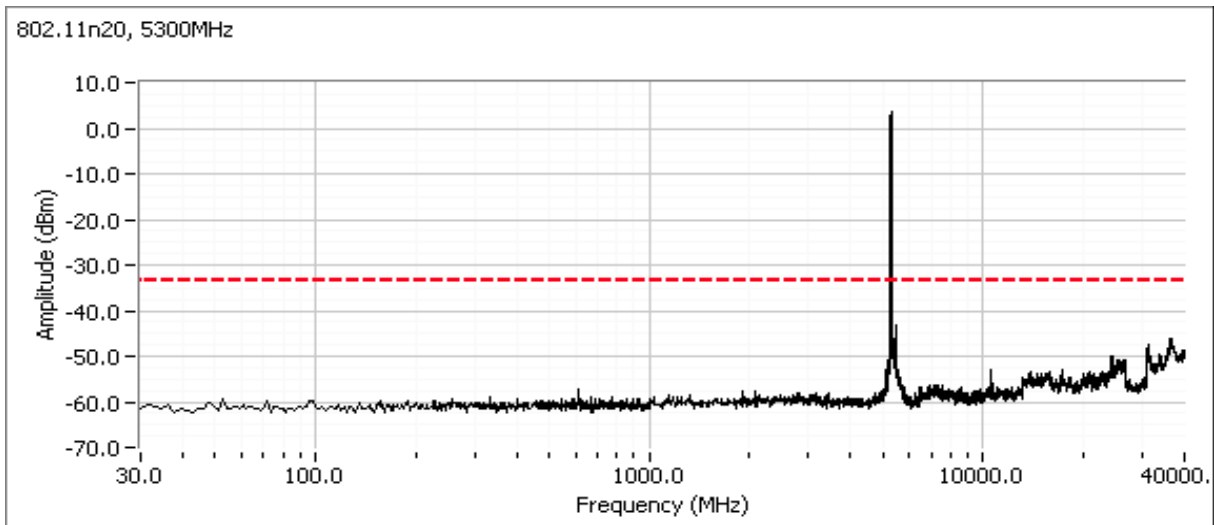

High channel, 5250 - 5350 MHz Band

Compliance with the radiated limits for the restricted band immediately above 5350MHz is demonstrated through the radiated emissions tests.

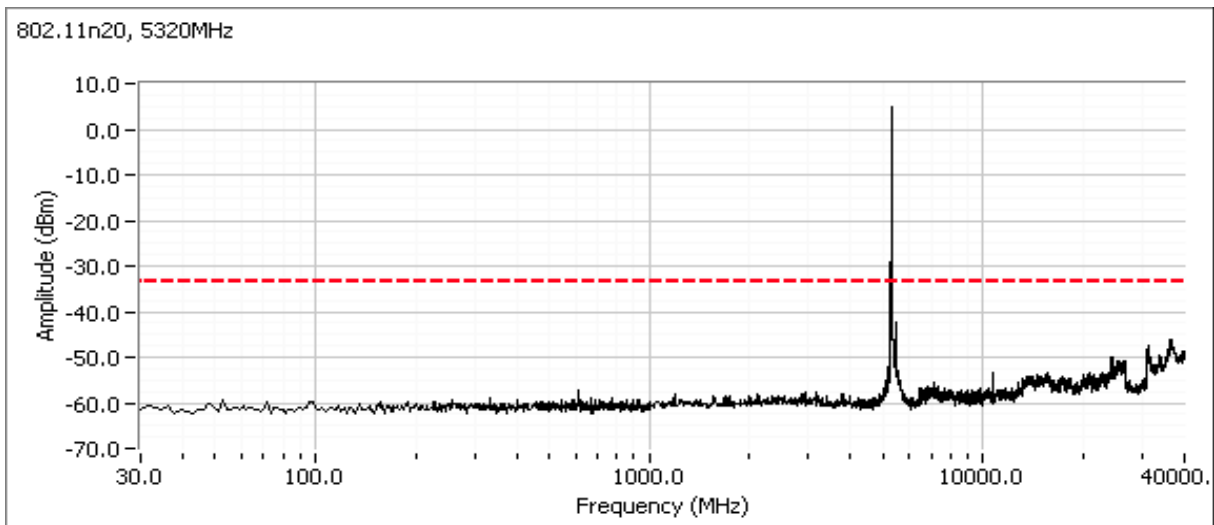

Client: Summit Data Communications	Job Number: J78403
Model: SDC-MSD40NBT (1x1 802.11abg + BT 2.1)	T-Log Number: T83196
	Account Manager: Christine Krebill
Contact: Ron Seide	
Standard: FCC 15.E/RSS-210	Class: N/A

Low channel, 5470 - 5725 MHz Band

Includes a plot from 5460 - 5470 MHz showing compliance with the limit immediately below the allocated band from 5460-5470 MHz. Compliance with the radiated limits for the restricted band below 5460 MHz is demonstrated through the radiated emissions tests.

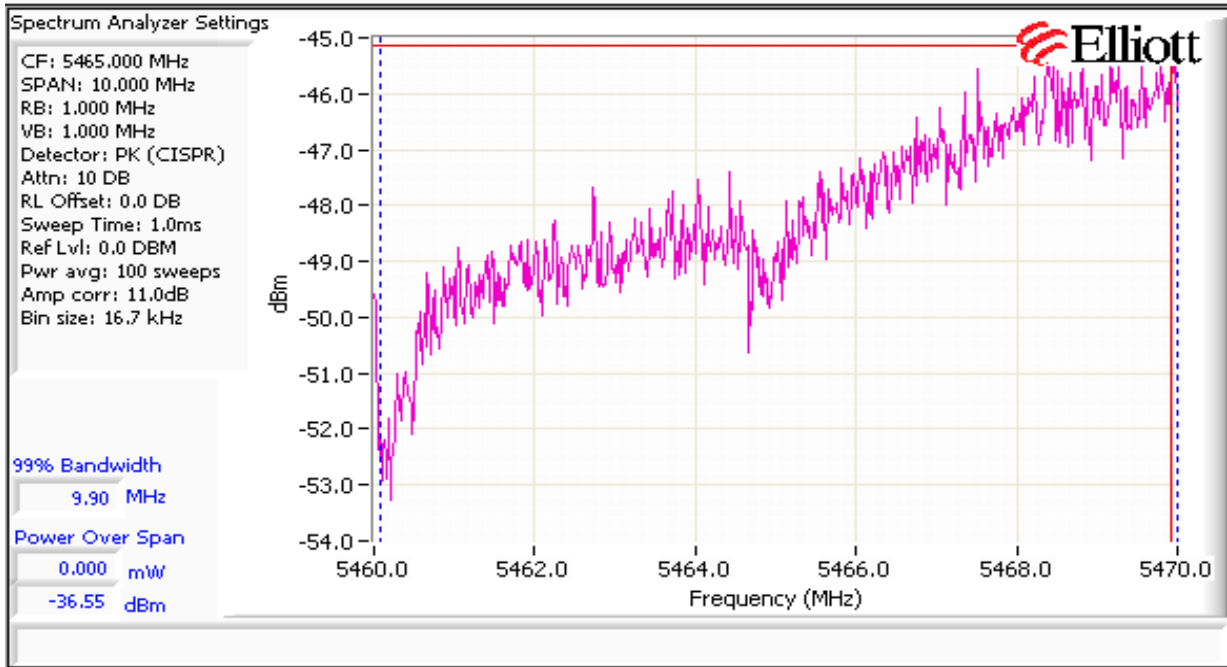
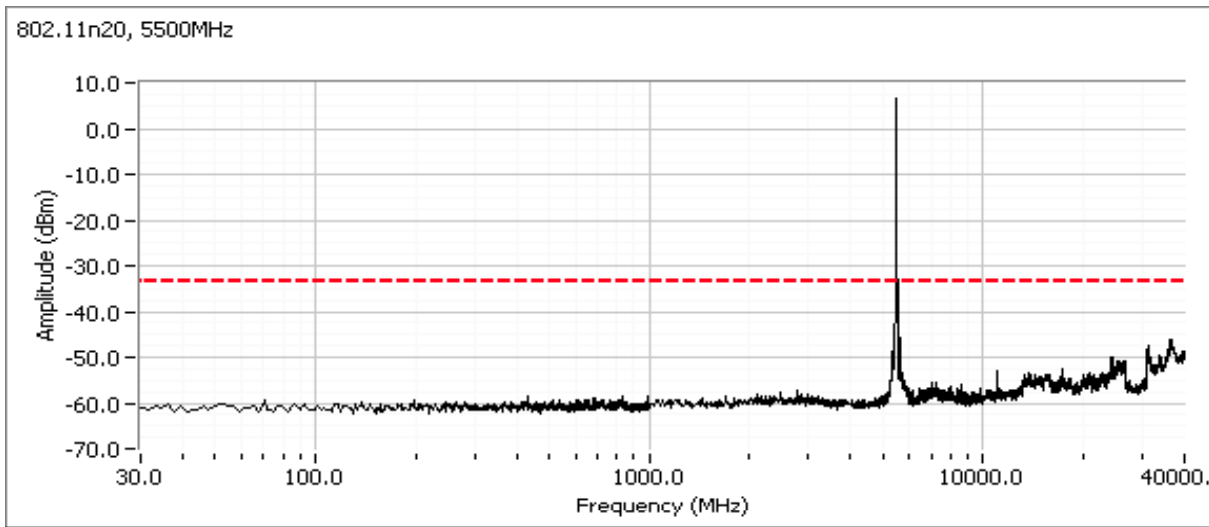

Client: Summit Data Communications	Job Number: J78403
Model: SDC-MSD40NBT (1x1 802.11abg + BT 2.1)	T-Log Number: T83196
	Account Manager: Christine Krebill
Contact: Ron Seide	
Standard: FCC 15.E/RSS-210	Class: N/A

Center channel, 5470 - 5725 MHz Band (20MHz channel use 5580 MHz, 40MHz channel use 5550 MHz)

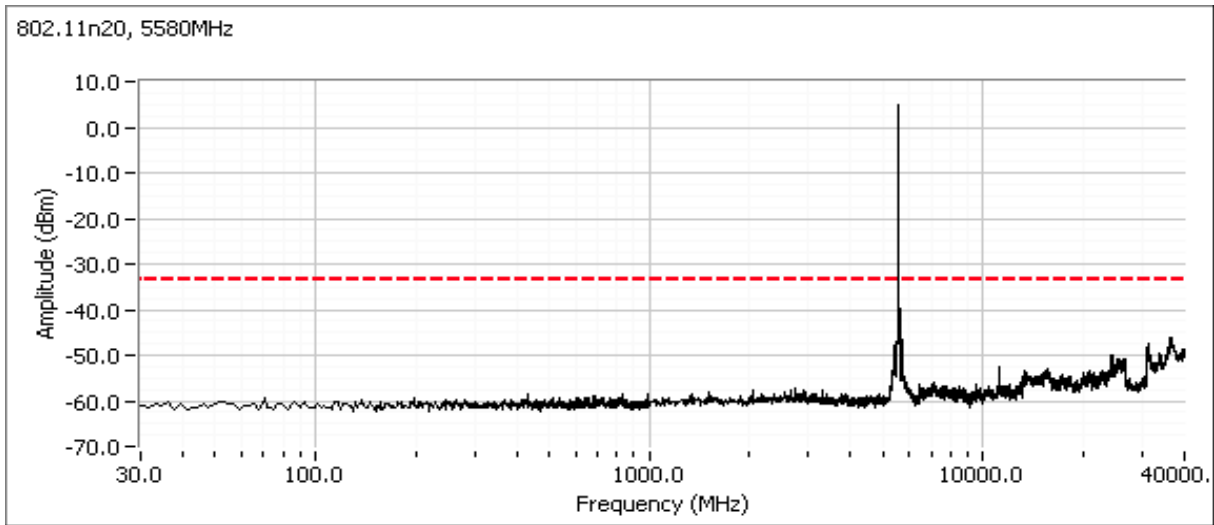

High channel, 5470 - 5725 MHz Band

Includes a plot from 5725 - 5780 MHz showing compliance with the -27dBm/MHz eirp limit immediately above the allocated band (5725 MHz).

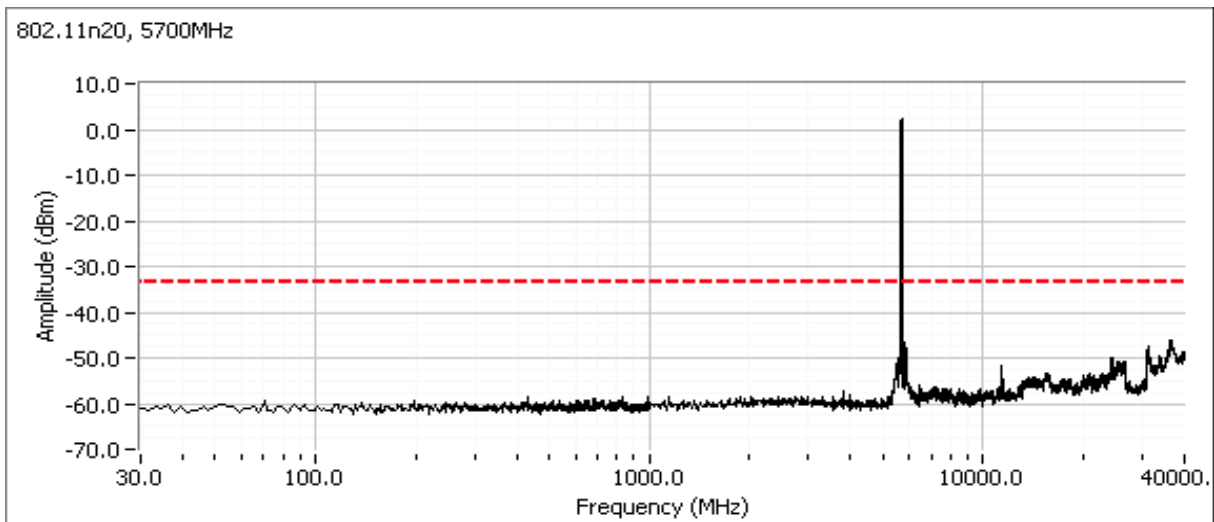

Client: Summit Data Communications	Job Number: J78403
Model: SDC-MSD40NBT (1x1 802.11abg + BT 2.1)	T-Log Number: T83196
	Account Manager: Christine Krebill
Contact: Ron Seide	
Standard: FCC 15.E/RSS-210	Class: N/A

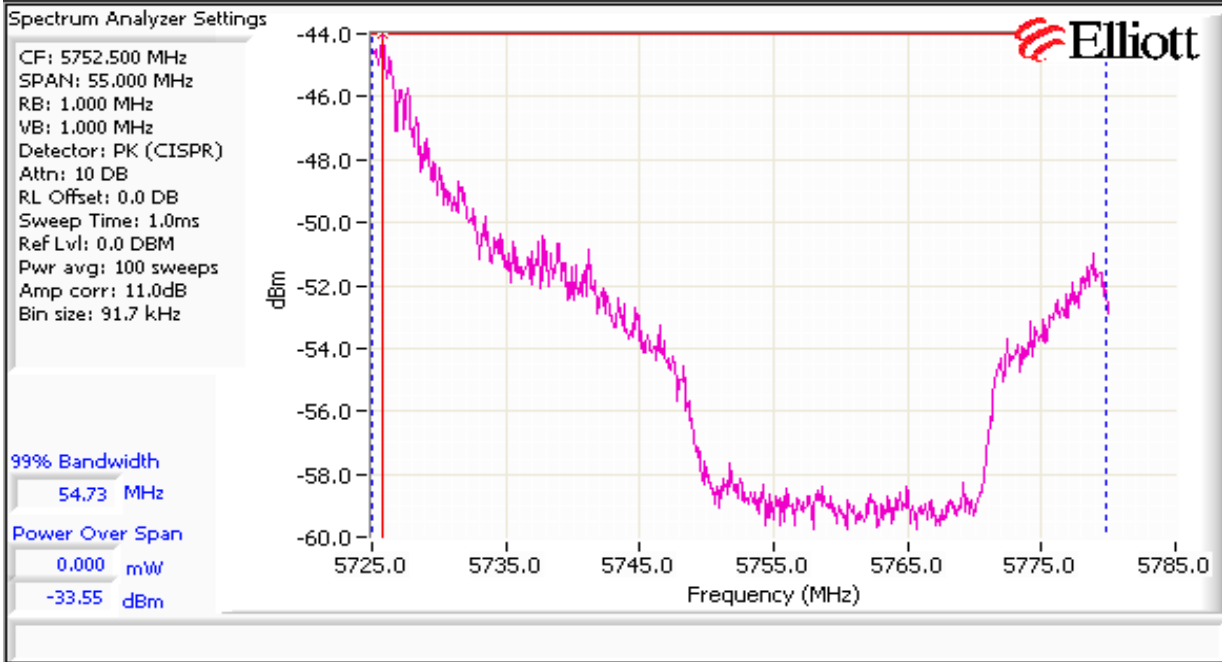

Client:	Summit Data Communications	Job Number:	J78403
Model:	SDC-WB40 and SDC-MSD40NBT (1x1 802.11abg + BT 2.1)	T-Log Number:	T83198
Contact:	Ron Seide	Account Manager:	Christine Krebill
Emissions Standard(s):	EN 301 489-1 V1.8.1/ FCC Part 15B	Class:	B
Immunity Standard(s):	EN 301 489-1 V1.8.1	Environment:	-

EMC Test Data

For The

Summit Data Communications

Model

SDC-WB40 and SDC-MSD40NBT (1x1 802.11abg + BT 2.1)

Date of Last Test: 12/16/2011

Client:	Summit Data Communications	Job Number:	J78403
Model:	SDC-WB40 and SDC-MSD40NBT (1x1 802.11abg + BT 2.1)	T-Log Number:	T83198
		Account Manager:	Christine Krebill
Contact:	Ron Seide		
Standard:	EN 301 489-1 V1.8.1/ FCC Part 15B	Class:	B

Conducted Emissions

(Elliott Laboratories Fremont Facility, Semi-Anechoic Chamber)

Test Specific Details

Objective: The objective of this test session is to perform final qualification testing of the EUT with respect to the specification listed above.

Date of Test: 12/16/2011	Config. Used: 2
Test Engineer: John Caizzi	Config Change: none
Test Location: Fremont Chamber #5	Host Unit Voltage 120V / 60Hz & 230V / 50Hz

General Test Configuration

For tabletop equipment, the EUT host system was located on a wooden table inside the semi-anechoic chamber, 40 cm from a vertical coupling plane and 80cm from the LISN. The EUT was transmitting on 2437 MHz, 802.11g, 6 Mbps.

Ambient Conditions:	Temperature:	21 °C
	Rel. Humidity:	33 %

Summary of Results

Run #	Test Performed	Limit	Result	Margin
1	CE, AC Power, 230V/50Hz	Class B	Pass	31.0dBμV @ 0.687MHz (-15.0dB)
2	CE, AC Power, 120V/60Hz	Class B	Pass	31.9dBμV @ 19.501MHz (-18.1dB)

Modifications Made During Testing

No modifications were made to the EUT during testing

Deviations From The Standard

No deviations were made from the requirements of the standard.

Client:	Summit Data Communications	Job Number:	J78403
Model:	SDC-WB40 and SDC-MSD40NBT (1x1 802.11abg + BT 2.1)	T-Log Number:	T83198
Contact:	Ron Seide	Account Manager:	Christine Krebill
Standard:	EN 301 489-1 V1.8.1/ FCC Part 15B	Class:	B

Run #1: AC Power Port Conducted Emissions, 0.15 - 30MHz, 230V/50Hz

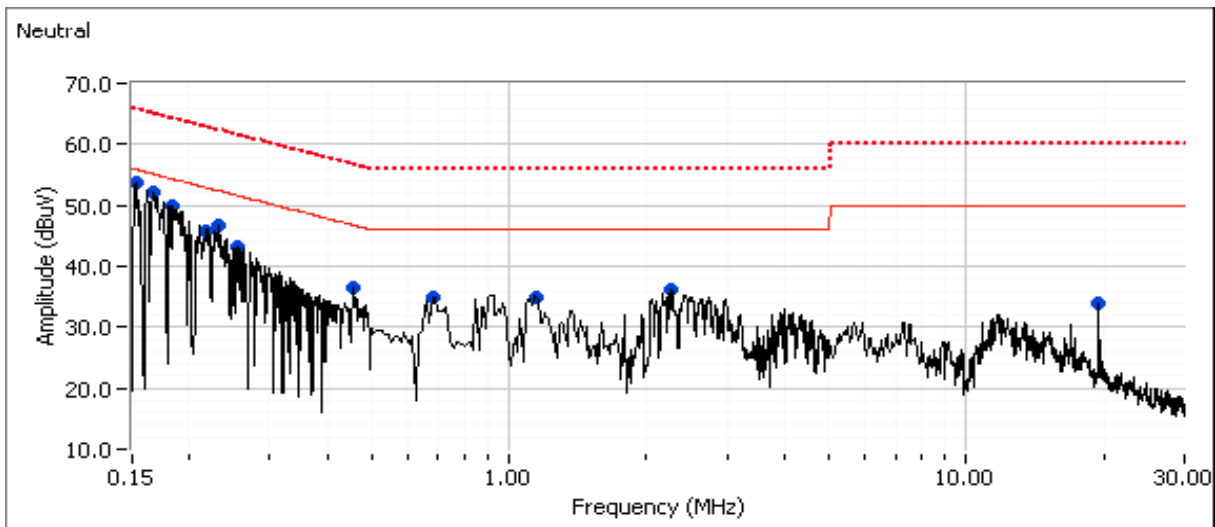
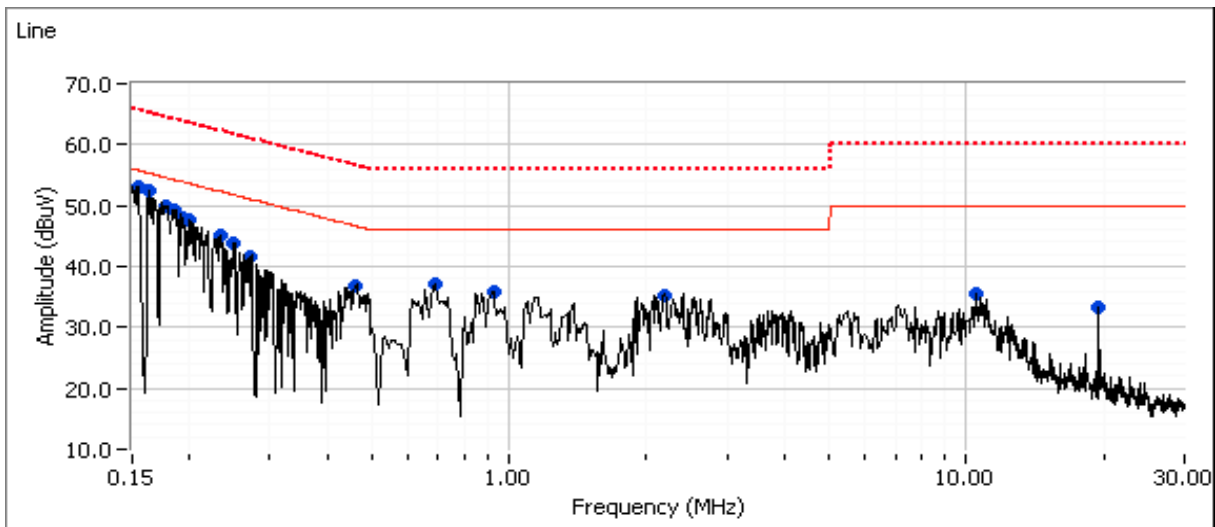



EMC Test Data

Client:	Summit Data Communications	Job Number:	J78403
Model:	SDC-WB40 and SDC-MSD40NBT (1x1 802.11abg + BT 2.1)	T-Log Number:	T83198
Contact:	Ron Seide	Account Manager:	Christine Krebill
Standard:	EN 301 489-1 V1.8.1/ FCC Part 15B	Class:	B

Preliminary peak readings captured during pre-scan (peak readings vs. average limit)

Frequency MHz	Level dB μ V	AC Line	Class B		Detector QP/Ave	Comments
			Limit	Margin		
0.153	53.0	Line	55.8	-2.8	Peak	
0.163	52.3	Line	55.3	-3.0	Peak	
0.178	49.8	Line	54.6	-4.8	Peak	
0.185	49.1	Line	54.3	-5.2	Peak	
0.195	48.1	Line	53.9	-5.8	Peak	
0.202	47.6	Line	53.6	-6.0	Peak	
0.234	45.1	Line	52.3	-7.2	Peak	
0.250	43.9	Line	51.7	-7.8	Peak	
0.687	37.0	Line	46.0	-9.0	Peak	
0.271	41.5	Line	51.1	-9.6	Peak	
0.464	36.9	Line	46.6	-9.7	Peak	
0.916	35.9	Line	46.0	-10.1	Peak	
2.173	35.2	Line	46.0	-10.8	Peak	
10.533	35.6	Line	50.0	-14.4	Peak	
19.501	33.3	Line	50.0	-16.7	Peak	
0.153	53.7	Neutral	55.8	-2.1	Peak	
0.167	52.1	Neutral	55.1	-3.0	Peak	
0.185	49.8	Neutral	54.3	-4.5	Peak	
0.232	46.7	Neutral	52.4	-5.7	Peak	
0.217	45.8	Neutral	52.9	-7.1	Peak	
0.255	43.2	Neutral	51.6	-8.4	Peak	
2.279	36.3	Neutral	46.0	-9.7	Peak	
0.458	36.6	Neutral	46.7	-10.1	Peak	
0.685	35.0	Neutral	46.0	-11.0	Peak	
1.141	34.8	Neutral	46.0	-11.2	Peak	
19.502	34.0	Neutral	50.0	-16.0	Peak	



EMC Test Data

Client:	Summit Data Communications	Job Number:	J78403
Model:	SDC-WB40 and SDC-MSD40NBT (1x1 802.11abg + BT 2.1)	T-Log Number:	T83198
Contact:	Ron Seide	Account Manager:	Christine Krebill
Standard:	EN 301 489-1 V1.8.1/ FCC Part 15B	Class:	B

Final quasi-peak and average readings

Frequency MHz	Level dB μ V	AC Line	Class B		Detector QP/Ave	Comments
			Limit	Margin		
0.153	17.5	Line	55.8	-38.3	AVG	
0.153	46.1	Line	65.8	-19.7	QP	
0.163	16.8	Line	55.3	-38.5	AVG	
0.163	44.7	Line	65.3	-20.6	QP	
0.178	16.1	Line	54.6	-38.5	AVG	
0.178	42.8	Line	64.6	-21.8	QP	
0.185	15.9	Line	54.3	-38.4	AVG	
0.185	41.8	Line	64.3	-22.5	QP	
0.195	15.7	Line	53.8	-38.1	AVG	
0.195	40.8	Line	63.8	-23.0	QP	
0.202	15.4	Line	53.5	-38.1	AVG	
0.202	40.1	Line	63.5	-23.4	QP	
0.687	31.0	Line	46.0	-15.0	AVG	
0.687	36.5	Line	56.0	-19.5	QP	
0.463	25.5	Line	46.6	-21.1	AVG	
0.463	34.1	Line	56.6	-22.5	QP	
0.916	28.9	Line	46.0	-17.1	AVG	
0.916	34.9	Line	56.0	-21.1	QP	
2.173	7.9	Line	46.0	-38.1	AVG	
2.173	33.6	Line	56.0	-22.4	QP	
10.533	20.5	Line	50.0	-29.5	AVG	
10.533	30.6	Line	60.0	-29.4	QP	
19.501	31.1	Line	50.0	-18.9	AVG	
19.501	32.0	Line	60.0	-28.0	QP	
0.153	17.6	Neutral	55.8	-38.2	AVG	
0.153	46.2	Neutral	65.8	-19.6	QP	
0.167	16.5	Neutral	55.1	-38.6	AVG	
0.167	44.3	Neutral	65.1	-20.8	QP	
0.185	15.8	Neutral	54.3	-38.5	AVG	
0.185	42.1	Neutral	64.3	-22.2	QP	
0.232	21.4	Neutral	52.4	-31.0	AVG	
0.232	37.5	Neutral	62.4	-24.9	QP	
0.216	14.6	Neutral	53.0	-38.4	AVG	
0.216	39.2	Neutral	63.0	-23.8	QP	
2.279	25.1	Neutral	46.0	-20.9	AVG	
2.279	32.6	Neutral	56.0	-23.4	QP	
0.458	28.8	Neutral	46.7	-17.9	AVG	
0.458	33.8	Neutral	56.7	-22.9	QP	

Client:	Summit Data Communications	Job Number:	J78403
Model:	SDC-WB40 and SDC-MSD40NBT (1x1 802.11abg + BT 2.1)	T-Log Number:	T83198
		Account Manager:	Christine Krebill
Contact:	Ron Seide		
Standard:	EN 301 489-1 V1.8.1/ FCC Part 15B	Class:	B

Frequency MHz	Level dB μ V	AC Line	Class B		Detector QP/Ave	Comments
			Limit	Margin		
0.685	29.4	Neutral	46.0	-16.6	AVG	
0.685	34.8	Neutral	56.0	-21.2	QP	
1.141	27.7	Neutral	46.0	-18.3	AVG	
1.141	34.5	Neutral	56.0	-21.5	QP	
19.502	30.2	Neutral	50.0	-19.8	AVG	
19.502	31.3	Neutral	60.0	-28.7	QP	

Client:	Summit Data Communications	Job Number:	J78403
Model:	SDC-WB40 and SDC-MSD40NBT (1x1 802.11abg + BT 2.1)	T-Log Number:	T83198
Contact:	Ron Seide	Account Manager:	Christine Krebill
Standard:	EN 301 489-1 V1.8.1/ FCC Part 15B	Class:	B

Run #2: AC Power Port Conducted Emissions, 0.15 - 30MHz, 120V/60Hz

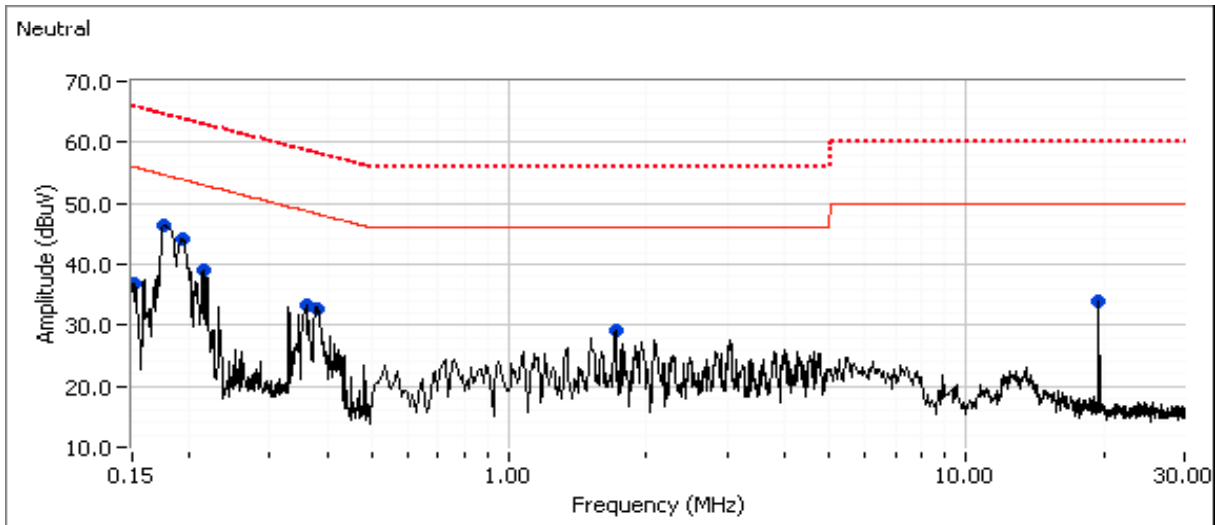
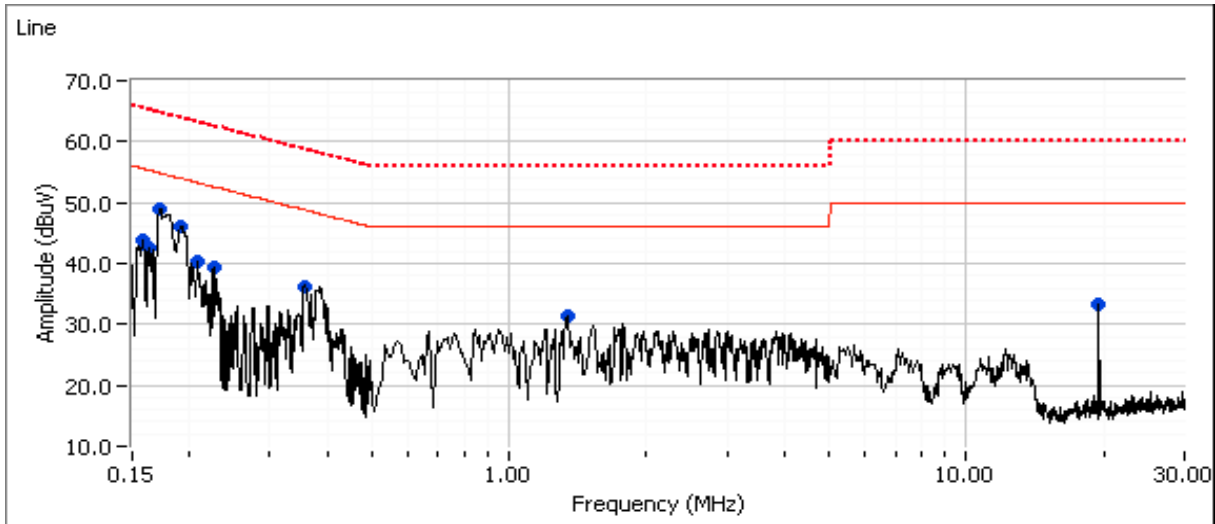



EMC Test Data

Client:	Summit Data Communications	Job Number:	J78403
Model:	SDC-WB40 and SDC-MSD40NBT (1x1 802.11abg + BT 2.1)	T-Log Number:	T83198
		Account Manager:	Christine Krebill
Contact:	Ron Seide		
Standard:	EN 301 489-1 V1.8.1/ FCC Part 15B	Class:	B

Preliminary peak readings captured during pre-scan (peak readings vs. average limit)

Frequency MHz	Level dB μ V	AC Line	Class B		Detector QP/Ave	Comments
			Limit	Margin		
0.173	48.8	Line	54.8	-6.0	Peak	
0.190	46.2	Line	53.9	-7.7	Peak	
0.158	43.8	Line	55.5	-11.7	Peak	
0.357	36.3	Line	48.8	-12.5	Peak	
0.164	42.5	Line	55.3	-12.8	Peak	
0.208	40.4	Line	53.3	-12.9	Peak	
0.225	39.3	Line	52.6	-13.3	Peak	
1.337	31.4	Line	46.0	-14.6	Peak	
19.502	33.2	Line	50.0	-16.8	Peak	
0.176	46.4	Neutral	54.7	-8.3	Peak	
0.192	44.0	Neutral	53.9	-9.9	Peak	
0.213	39.1	Neutral	53.0	-13.9	Peak	
0.379	32.8	Neutral	48.3	-15.5	Peak	
0.360	33.2	Neutral	48.7	-15.5	Peak	
19.501	34.0	Neutral	50.0	-16.0	Peak	
1.717	29.2	Neutral	46.0	-16.8	Peak	
0.152	36.9	Neutral	55.9	-19.0	Peak	

Client:	Summit Data Communications	Job Number:	J78403
Model:	SDC-WB40 and SDC-MSD40NBT (1x1 802.11abg + BT 2.1)	T-Log Number:	T83198
Contact:	Ron Seide	Account Manager:	Christine Krebill
Standard:	EN 301 489-1 V1.8.1/ FCC Part 15B	Class:	B

Final quasi-peak and average readings

Frequency MHz	Level dB μ V	AC Line	Class B		Detector QP/Ave	Comments
			Limit	Margin		
0.173	14.0	Line	54.8	-40.8	AVG	
0.173	44.3	Line	64.8	-20.5	QP	
0.190	33.5	Line	54.0	-20.5	AVG	
0.190	44.4	Line	64.0	-19.6	QP	
0.158	12.7	Line	55.6	-42.9	AVG	
0.158	31.5	Line	65.6	-34.1	QP	
0.357	10.7	Line	48.8	-38.1	AVG	
0.357	32.2	Line	58.8	-26.6	QP	
0.164	14.3	Line	55.3	-41.0	AVG	
0.164	41.0	Line	65.3	-24.3	QP	
0.208	16.0	Line	53.3	-37.3	AVG	
0.208	34.6	Line	63.3	-28.7	QP	
0.225	11.7	Line	52.6	-40.9	AVG	
0.225	23.9	Line	62.6	-38.7	QP	
1.337	21.3	Line	46.0	-24.7	AVG	
1.337	29.5	Line	56.0	-26.5	QP	
19.502	29.8	Line	50.0	-20.2	AVG	
19.502	30.4	Line	60.0	-29.6	QP	
0.176	16.4	Neutral	54.7	-38.3	AVG	
0.176	44.4	Neutral	64.7	-20.3	QP	
0.192	27.9	Neutral	53.9	-26.0	AVG	
0.192	42.6	Neutral	63.9	-21.3	QP	
0.213	12.2	Neutral	53.1	-40.9	AVG	
0.213	33.1	Neutral	63.1	-30.0	QP	
0.379	23.7	Neutral	48.3	-24.6	AVG	
0.379	30.7	Neutral	58.3	-27.6	QP	
0.360	17.3	Neutral	48.7	-31.4	AVG	
0.360	29.3	Neutral	58.7	-29.4	QP	
19.501	31.9	Neutral	50.0	-18.1	AVG	
19.501	32.6	Neutral	60.0	-27.4	QP	
1.717	10.7	Neutral	46.0	-35.3	AVG	
1.717	18.8	Neutral	56.0	-37.2	QP	
0.152	11.4	Neutral	55.9	-44.5	AVG	
0.152	30.6	Neutral	65.9	-35.3	QP	

End of Report

This page is intentionally blank and marks the last page of this test report.